



2024

Dadant Beekeeping Catalog

Online dadant.com **Toll-Free** 888.922.1293

FREQUENTLY ASKED QUESTIONS ABOUT BEEKEEPING

When do I order package bees?

It is best to order package bees at the beginning or very early in the year for spring delivery. The bees should be delivered after the date of the last hard freeze for your region. The package honey bee suppliers will be able to help you determine the best delivery date.

When should I hive my new package of honey bees?

The best time to hive the honey bees is late afternoon or early evening. Spray the honey bees with sugar water while still in the shipping container. This will make it easier to put the honey bees in the hive.

What kind of frames should I use when starting with package bees?

It is best not to mix solid plastic frames with wood frames when hiving package bees. It is confusing to the bees when mixed. We recommend using wood frames when hiving package bees.

What do I feed the honey bees in the spring?

It is best to feed a mixture of sugar and water in a one to one ratio. The bees will use the sugar syrup mixture until natural sources are available. In the fall, use a two part sugar to one part water mixture if the bees do not have adequate winter stores. Feeders on pages 41 -43 work well. You can also stimulate the honey bees to raise brood by feeding them Dadant's Brood Builder Patties or AP23® Patties. These items can be found on pages 46 and 48.

Where do I place my hive?

If you are in the city, you should put the entrance of the hive facing a high fence. This will force the bees to fly in a high flight pattern, avoiding neighbors. It is good to give the hives a wind break to protect them. You can also place the entrance facing the sun to allow the bees an early start in the morning. The hive can also be placed on a hive stand, concrete blocks or a wooden pallet to keep it off of the ground.

Do I paint the inside of the beehive?

No, paint the outside of the beehive only. Allow the paint to dry thoroughly before installing the bees.

How often should I check my new hive?

You can open the hive after a few days to see if the queen has been released. Look in the Queen Cage to

see if the Queen has been released. If the Queen has been released, you should check for eggs and larvae to be sure she is active. If the Queen has not been released, enlarge the hole in the candy in the Queen Cage. Three weeks after you have hived the package, you can examine the colony again. Be sure to keep feeding the colony sugar syrup during this time to stimulate comb building. You should see sealed brood in the colony at this time.

Can I keep bees in a straw skep?

No, honey bees are required to be kept in a beehive with removable frames. This is to allow inspection for diseases. It is the law in all states.

When should I add a second hive body or super?

You should add the second hive body or super when the majority of the frames in the first hive body are fully drawn out, (8 or 9 frames). A second super should be added after the first super is about one half full.

How much honey should I leave on the hive to overwinter?

As a general rule, you should have a full super or second hive body and 20 to 30 pounds of honey in the brood nest. This will amount to a total of 60 to 70 pounds of honey for winter and early spring consumption.

What should I look for in spring in the colony?

You should check for evidence that the Queen is laying eggs. You should also check the honey stores and pollen supply. If the honey stores are low, you may start feeding sugar syrup in a one to one ratio of sugar and water. The bees may consume about 10 pounds of sugar syrup in a one-week period.

How can I get information or help about beekeeping in my area?

All 50 states have state and local associations and are a very good source of information and help. They will be able to direct you to a bee club or an association in your area.

For contact information on the state associations call us at 1-888-922-1293 or visit <http://americanbeejournal.com/tiposlinks/beekeeping-associations/>.

**THE HONEY BEE IS THE ONLY INSECT
THAT PRODUCES FOOD EATEN BY MAN.**



QUALITY WOODENWARE — A DADANT MANUFACTURING SPECIALTY

Hive Customization

At Dadant we understand that beekeepers do things their own way. That said we are happy to customize your bee hive needs. From branding, painting, dipping, and assembly we can customize your bee hive to fit your style. Give your local Dadant location a call about customizing your hives today. All customized orders must meet the minimum requirement of 500+ hives to qualify.

Branding

With all the beehive thefts going on within the industry we have been asked by many to bring branding back to our line of customization. We are happy to do so. Let us know what you would like branded and we will do our best to accommodate your needs.

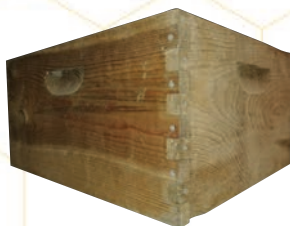

Painting and Dipping

We are happy to be able to offer unpainted, painted, and dipped boxes. Our protective coatings will help your boxes last for years to come. Inquire today about other colors or copper methanolamine dipped boxes. Copper methanolamine dipped boxes only available through our High Springs, FL office. Lead times may vary. Ordering in advance is encouraged.

Imprinting of Frames

Dadant assembled frames will be stamped with our logo and year unless otherwise requested. If you wish to have your logo or something else stamped we are happy to try and accommodate your needs. Give us a call at 888-922-1293 today.



Hive Bodies And Honey Supers

- **HANDHOLDS** tapered cut for easy gripping
- **MOISTURE METERING** before cutting to prevent warping
- **UNIFORM INTERLOCKING JOINTS** to prevent cracking
- **PONDEROSA PINE** from the Northwest. The best wood for the job.
- **UNIFORM FRAME RESTS** provides the proper "Bee Space"
- **PRE-DRILLED NAIL HOLES** to prevent splitting
- **INTERLOCKING CONSTRUCTION** for superior strength



Dadant Construction ...
Small Details Make A Big Difference
Ponderosa Pine Wood Products

Our woodenware is manufactured from hand selected Ponderosa Pine. Each board has been carefully moisture-metered to assure its proper moisture content before it is precision-milled into the finished product. All our hive bodies and supers have "pre-drilled" holes for nails to prevent splitting during assembly.

3 Basic Grades

Select — A grade that is truly "selected" which allows only very small tight knots and no deviations in the joints, rabbets, or handholds.

Commercial — The most widely used by commercial beekeepers. Tight knots are allowed where they occur except in the joint and rabbet.

Economy — The same precise fit as the other two grades but is a lower wood quality. Does not pass quality standards for "select" or "commercial" but is a good serviceable box. Layer knots and knots with cracks or splits are allowed.

DADANT QUALITY FRAMES



Dadant Frame Construction

- 8% more wood in end bars (Full 3/8" thickness)
- Grooved bottom bar stronger and easier to use

— 2 Frame Styles —

Wedge Top Bar

- 1) Wood wedge is removed from frame.
- 2) Foundation is placed in frame.
- 3) Wood wedge is held firmly against foundation and nailed or stapled in place.

Grooved Top Bar

Foundation is placed in bottom-bar groove and top-bar groove. This frame works best with a rigid foundation such as Plasticell.

We will strive to maintain woodenware prices; however, due to escalating lumber costs, wood price increases may be necessary.

NOTE: Unless otherwise specified, frames with grooved bottom bars will be shipped. SOLID AND SLOTTED BOTTOM BARS ARE AVAILABLE IN 100 OR MORE QUANTITIES. Please specify bottom bar desired.

BEEHIVE COMPONENTS

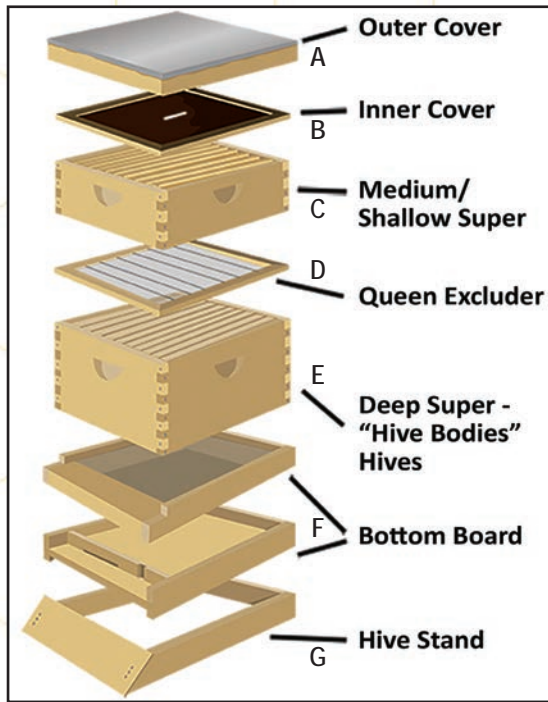

The modern beehive is like a highly efficient multi-storied factory with each “story” having a specific function. These “stories” work together to provide a home for bees and a honey factory for the beekeeper.

A) Outer Cover — Telescoping cover “telescopes” over the sides of the top super to protect the hive. Galvanized covering.

B) Inner Cover — Creates a dead air space for insulation from heat and cold.

C) Shallow Supers — For “surplus” honey storage. Bees store their extra honey in these for the beekeeper to take. 6 $\frac{1}{2}$ ”, 5 $\frac{1}{16}$ ” supers or even hive bodies may be used.

D) Queen Excluder — Keeps the queen bee in the brood chambers as she is too large to pass through the excluder. Prevents her from laying eggs and raising brood in honey supers placed above the excluder.

E) Hive Bodies — “Brood Chambers” are the bees’ living quarters. The queen lays eggs in these chambers and brood is raised. Honey and pollen is also stored for the bees’ food.

F) Bottom Board — Forms the floor of the hive. Shown with wooden entrance reducer in place to keep mice and some cold out during winter.

G) Hive Stand — Supports the hive off the ground to keep hive bottom dry and insulate hive.

Successful beekeeping means easy manipulation of the frames of brood and honey to provide a “surplus” of honey beyond that needed by the bees to live on and rear their replacements. It is this “surplus” that the beekeeper removes and markets.

BEEKEEPING EQUIPMENT

The Frame

The modern hive for the honey bee as provided by *Dadant and Sons* is the perfect home for your honey bees and makes beekeeping remarkably simple and enjoyable. The hive is constructed to hold movable frames which in turn hold pure beeswax foundation (starter sheets for honeycomb). These frames hold the honeycomb that the honey bees make. The honeycomb provides storage space for honey and new bees develop in its individual six sided cells.



The Hive Body (brood chamber)

These large boxes containing ten (10) frames are the heart of the honey bee colony. Usually two hive bodies are used year round for the honey bees to use as an area to raise brood (larva and pupa) and to store extra food for themselves for use during winter when no nectar is available.



The Super

Additional boxes, usually smaller than the hive bodies, with movable frames are set on top of the brood chamber and provide space for the honey bee to store surplus honey which the beekeeper will harvest. The word Super comes from the word Superimpose which means, “to place in a covering position, to overlay.”



The Smoker

The smoker is a metal container with air pumping bellows attached. A smoldering fire is built in the metal fire chamber and the bellows are used to blow the smoke produced out through a nozzle at the top of the smoker.

When lightly puffed into a colony of honey bees the smoke causes a temporary confusion and disorganization within the colony. The honey bee’s group defensive behavior is disrupted. This allows the beekeeper to move calmly and to comfortably inspect the interior of their colonies.

The Hive Tool

Honey bees collect a miscellaneous product called propolis from tree gums, saps and resins — anything sticky. This they use to seal cracks and crevices within the hive. Because of the sticky nature of this product a special tool is used for those times when a little leverage is necessary to remove frames, supers, etc. from the hive.

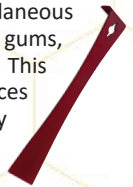

The Bee Veil

The bee veil protects the face and neck. Many times it is made from wire mesh to help the veil stand away from the face.



The Gloves

There are a variety of types and styles of gloves available from *Dadant & Sons*. Gloves provide the beekeeper with protection when working the honey bee colony.



ATTENTION: DADANT PACKAGE BEE CUSTOMERS

for Pick-up only at Dadant Branches

At the selected Dadant offices listed below, bees will be available for pick-up. For details of day, time, location and cost, call your nearest Dadant Branch Location. (Most pickup days are mid-April.)

Fresno, CA - 877-432-3268

Frankfort, KY - 888-932-3268

Williamsport, PA- 877-532-3268

Sioux City, IA - 877-732-3268

Albion, MI - 877-932-3268

Chatham, VA - 800-220-8325

Hamilton, IL - 888-922-1293

Watertown, WI - 877-232-3268



V02004S

V02004L

Package Bee Netting | Nuc Bee Netting

When we saw customers putting package bees in plastic tubs for the car ride home we thought we'd find a better way to help secure your cargo. Our package bee and nuc bee netting is perfect for the ride home with no escapees. Each fit over a 3 lb. package of bees or a 5-frame nuc box. Get your bee netting today to be safe on the ride home.

V02004S Package Bee Netting, Actual wt. 0.2 lbs... \$6.25

V02004L Nuc Bee Netting, Actual wt. 0.36875 lbs. . . \$7.15

B-Funnel

The B-Funnel is designed to reduce stress and save time and effort when installing package bees. Made of corrugated plastic, it is very easy to put together and use. A velcro strap holds it securely against the hive. The beekeeper then positions the bee cage on top of the funnel. The B-Funnel channels the bees directly into the hive, reducing the number of bees in the air. It assists the bees in finding their new home, is less stressful for the bees, and can be removed as soon as the bees have left the package box. Fits 8- and 10-frame hives.



M01985

M01985 B-Funnel, Actual wt. 0.27 lbs..... \$13.95



PACKAGE BEES

We ship them direct to your local post office

AVAILABLE SPRING 2024!

\$187.95 ea.

5 or more \$184.95 ea.

- Approximately 3 lbs. of Bees per Package
- Naturally Mated Italian Queen Included
- Calm and Gentle Italian Bees
- No Cage Exchange Necessary

DADANT COMPLETE HIVES & SUPERS

We Now Offer Assembled Equipment Primed and Painted for You.

No Paint to Buy! No Mess to Clean! (1 primer coat and 1 white exterior latex coat)



6⁵/₈ Painted Super

C31501P comes assembled with 10 - 6⁵/₈" Grooved top bar frames with wax coated Plasticell foundation installed in the frames. Commercial grade wood, painted. Actual wt. 13.2 lbs.

C31501P Carton of 1 **\$74.95 ea.**



9⁵/₈ Painted Hive Body

C51101P comes assembled with 10 - 9⁵/₈" Grooved top bar frames with wax coated Plasticell foundation installed in the frames. Commercial grade wood, painted. Actual wt. 17.8 lbs.

C51101P Carton of 1 **\$79.95 ea.**



Assembled/Painted Bottom Board

Actual wt. 5.8 lbs. each
C91201P **\$33.95 ea.**



Assembled/Painted Tele Cover (only)

Actual wt. 6.45 lbs. each
C11001P **\$44.95 ea.**

B15201 Inner Cover sold separately (see page 22)
Actual wt. 2.65 lbs. **\$19.75 ea.**



10-Frame Ultimate Pine Hive Stand with West Beetle Trap & IPM Board

Made of pine, this all in one painted bottom board will trap and kill SHB, allow you to check for mites with the included IPM board, and gives your bees a landing board to land on. **Assembled/Painted**
M60090 Actual wt. 5.5 lbs. **\$46.95**

Complete Hive with Wax Coated Plasticell Foundation



- 10 — 9⁵/₈" Grooved top bar frames with wax coated plasticell foundation
- Superbly constructed 9⁵/₈" commercial Ponderosa Pine hive body, painted
- Painted telescoping cover with galvanized metal top
- Inner cover
- Reversible painted bottom board for summer and winter bee entrance

Ships in multiple cartons Actual wt. 32 lbs.

C52101P Carton of 1 **\$169.95 ea.**

Call for quote on large quantity pricing on unpainted hives or supers.

While we hope to maintain prices at all locations, escalating freight costs may necessitate occasional adjustments.

— NO SUBSTITUTIONS OR PARTIAL RETURNS ON KITS —

1-888-922-1293



Assembled & Painted

C52501P

6 5/8" Assembled Starter Kit

- 3 - 6 5/8" supers
- 30 - 6 1/4" grooved top bar frames
- 30 - sheets plastic based foundation
- 1 - bottom board
- 1 - telescoping metal cover
- 1 - inner cover
- 1 - reversible entrance reducer
- 1 - plastic queen excluder
- 1 - entrance feeder
- 1 - all purpose hive tool
- 1 - 4" x 7" bee smoker to calm bees (M00926)
- 1 - smoker fuel 1 lb.
- 1 - bee brush
- 1 - Alexander veil
- 1 - economy leather gloves — large
- 1 - book *First Lessons in Beekeeping*

C52501P 6 5/8" Assembled Starter Kit. **\$412.95**

Ships in multiple packages: Actual wt. 64 lbs.

Master Pollinator Kit

- 1 - Assembled painted telescoping metal cover
- 2 - Assembled painted hive bodies with wooden frames & plasticell
- 1 - Assembled Painted Bottom board
- 1 - Inner cover
- 1 - Smoker - 4" x 7" Stainless Steel with shield
- 2 - 1 lb. of smoker fuel
- 1 - Entrance feeder
- 1 - Metal 9 1/2" hive tool
- 1 - Bee brush
- 1 - Dadant zipper veil suit (available in S, M, L, XL, 2XL, 3XL, 4XL)
- 1 - Economy leather gloves (available in S, M, L, XL, XXL)
- 1 - Dadant plastic helmet
- 1 - Book—*First Lessons in Beekeeping*
- 1 - Book—*The Hive and the Honey Bee*
- 1 - 1 Year Subscription—*American Bee Journal*

Please state suit and glove size when ordering.

M58001 Master Pollinator Kit. **\$436.95**

Ships in multiple packages: Actual wt. 85 lbs.



Assembled & Painted

C52201P

Assembled Starter Kit

Here at Dadant we strive to make sure you, the beginning beekeeper, have everything you need to start a successful beekeeping venture.

- 1 - bottom board
- 2 - deep brood boxes with frames and plasticell foundation
- 1 - medium depth super with frames and plasticell foundation
- 1 - inner cover and top cover
- 1 - plastic queen excluder
- 1 - boardman entrance feeder
- 1 - reversible entrance reducer
- 1 - hive tool
- 1 - 4" x 7" smoker to calm bees (M00926)
- 1 - smoker fuel 1 lb.
- 1 - bee brush
- 1 - Hat Veil Pullover Combo
- 1 - economy leather gloves
- 1 - book *First Lessons in Beekeeping*

Please state glove size when ordering.

C52201P Assembled Starter Kit. **\$430.95**

Ships in multiple packages: Actual wt. 70 lbs.



Assembled & Painted

— NO SUBSTITUTIONS OR PARTIAL RETURNS ON KITS —



C52301P

Assembled & Painted

Expanding Apiary Kit
— Assembled & Painted—

The expanding apiary kit is all you will need to add a hive to your operation. The kit comes completely assembled and painted with a Ponderosa pine bottom board, two full depth 9 $\frac{1}{2}$ " brood boxes, two medium 6 $\frac{5}{8}$ " depth honey supers, assembled frames with plasticell foundation, inner cover with telescoping cover and entrance reducer.

C52301P \$349.95

Ships in multiple packages: Actual wt. 80 lbs.



PONDEROSA PINE LASTS LONGER

6 $\frac{5}{8}$ " Expanding Apiary Kit
— Assembled & Painted —

The 6 $\frac{5}{8}$ " kit is all you need to add a hive to your operation. Comes completely assembled, painted and ready for the bee yard with a Ponderosa pine bottom board, four 6 $\frac{5}{8}$ " supers, assembled frames with plasticell foundation, inner cover with telescoping cover and entrance reducer.

C52401P \$349.95

Ships in multiple packages: Actual wt. 71 lbs.



Assembled & Painted

C52401P

Call for quote on large quantity pricing on unpainted hives or supers.
While we hope to maintain prices at all locations, escalating freight costs may necessitate occasional adjustments.
— NO SUBSTITUTIONS OR PARTIAL RETURNS ON KITS —

DADANT UNASSEMBLED HIVES & SUPERS

Complete Hive without foundation

— UNASSEMBLED —

- Telescoping cover with galvanized metal top



B52101

- Superbly constructed 9⁵/₈" select grade Ponderosa Pine hive body

Not Assembled

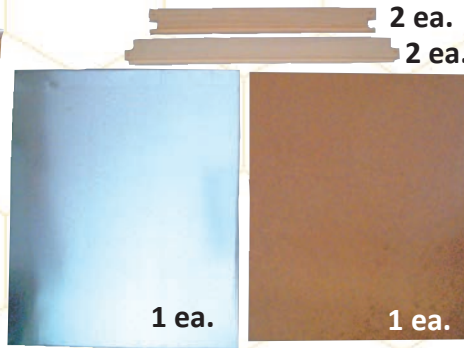

• Inner Cover



1 ea.



2 ea.

2 ea.

- Reversible Bottom Board for summer and winter bee entrance



2 ea.

- 10 - 9⁵/₈" Wedged Top Bar Frames



10 ea.

10 ea.

20 ea.



2 ea.

NAILS INCLUDED FOR ALL COMPONENTS.

FRAME RESTS NOT INCLUDED

B52101 Actual wt. 27.84 lbs.
Carton of 1..... \$109.95
5 or more..... \$101.95

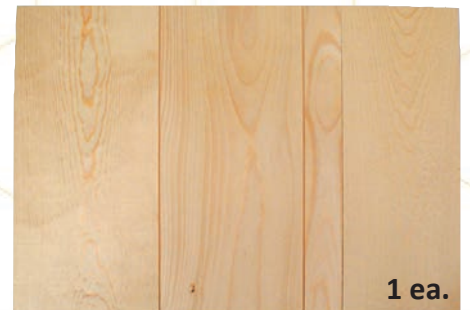

1 ea.



2 ea.

1 ea.

1 ea.

1 ea.

Wood Entrance Reducer

Notice: Select Wood may not be available at all branch locations.

Hive Body with Frames

B51101



2 ea.



2 ea.

20 ea.



10 ea.



10 ea.

Not Assembled

B51101 - Unassembled with 10 Wedged Top Bar Frames. Nails included. **Select Grade Wood.**

Actual wt. 14.02 lbs.

B51101 Carton of 1..... \$49.95 ea.

Frame rests not included

6⁵/₈" Depth Super with Frames
Actual wt. 10.72 lbs.

B31101 Carton of 1..... \$41.95 ea.

5¹/₁₆" Depth Supers with Frames
Actual wt. 10.05 lbs.

B32101 Carton of 1..... \$40.95 ea.

Honey Supers With Frames

B31101



2 ea.



2 ea.

20 ea.



10 ea.



10 ea.

B31101 & B32101 Unassembled with 10 wedged Top Bar Frames. Nails included. Select Grade Wood.

— NO SUBSTITUTIONS OR PARTIAL RETURNS ON KITS —

See page 11 for your favorite Dadant foundation.

While we hope to maintain prices at all locations, escalating freight costs may necessitate occasional adjustments.

ESSENTIALS OF BEEKEEPING — BEGINNERS KITS

Beginner's Kit #1

Beginner Kit No. 1 contains everything necessary for the beginner to start that first colony of bees except the bees themselves. Unassembled kit with the best grade wood. As your colony grows, we recommend the Hobby Kit #3 for the additional items needed for production of a honey crop. Actual wt. 39.65 lbs.

- 1 - standard beehive
- 10 - 9 $\frac{1}{8}$ " grooved top bar frames
- 10 - sheets plastic based foundation
- 1 - bottom board
- 1 - inner cover
- 1 - telescoping metal cover
- 1 - reversible entrance reducer
- 1 - entrance feeder
- 1 - all purpose hive tool
- 1 - bee smoker to calm bees
- 1 - smoker fuel 1 lb.
- 1 - Hat Veil Pullover Combo
- 1 - sting resistant gloves - large
- 1 - book *First Lessons in Beekeeping*
- 1 - assembly instructions

M58101 \$239.95



Hobby Kit #2

Hobby Kit No. 2 contains everything needed to get started in beekeeping except the bees themselves. Using the standardized size of 6 $\frac{5}{8}$ " for both brood boxes and supers eliminates confusion of reordering multiple sizes of frames & foundation. Smaller size makes for easier handling. Actual wt. 45.4 lbs.

- 2 - 6 $\frac{5}{8}$ " supers
- 20 - 6 $\frac{1}{4}$ " grooved top bar frames
- 20 - sheets plastic based foundation
- 1 - bottom board
- 1 - telescoping metal cover
- 1 - inner cover
- 1 - reversible entrance reducer
- 1 - entrance feeder
- 1 - all purpose hive tool
- 1 - bee smoker to calm bees
- 1 - smoker fuel 1 lb.
- 1 - Hat Veil Pullover Combo
- 1 - sting resistant gloves - large
- 1 - book *First Lessons in Beekeeping*
- assembly instructions

M59601 \$289.95



Hobby Kit #3

For Those Desiring To Produce Extracted Honey
Hobby Kit No. 3 is designed to accommodate those who intend to produce extracted honey. Kit #3 contains two 6 $\frac{5}{8}$ " supers with frames, foundation and plastic excluder. Actual wt. 25.22 lbs.

- 2 - 10 pack Plasticell 5 $\frac{1}{2}$ " coated
- 1 - plastic excluder
- 2 - 6 $\frac{5}{8}$ " Supers
- 2 - c/10 GTB frames for supers
- assembly instructions

B38301 \$176.95



DADANT FOUNDATION — THE KEY TO SUCCESSFUL BEEKEEPING

Fresh Quality Foundation Makes Good Productive Combs

Dadant Quality Foundations—
Only 100% Pure U. S. Beeswax Is Used

Plain No Wire (Medium Brood)
The Original 100% Pure Beeswax Foundation

Our Lowest Priced Foundation

Precise Even-Milled
Worker-Sized Deep
Walled Cells

We Recommend Cross Wiring
Frames With Medium Brood Foundation

Crimp Wired
Developed By Dadant & Sons
Copied But Unequalled

Steel Hook Fits Behind Wedge
In Top Bar

9 Vertical Crimped Steel Wires
Perfectly Milled Cells
Deep Exact Walls
Radiate Strength

We Recommend Adding Cross Wires In Deep Frames

Cut Comb
Finest Comb Honey Foundation 100% Beeswax



Cut comb is slightly heavier than thin surplus
for easier handling. Cut Comb For Chunk Honey and
Comb Honey Cut From The Frame

Thin Surplus



The thinnest beeswax sheet
for the finest comb honey. Thin Surplus For
Square and Round Section Comb Honey

“Plasticell”
Raised-Cell Sheet, Best Plastic Foundation
Available, Tested and Proven



Wax Coated or Plain
(We recommend
Wax Coating.)

Deep Uniform
Exact Cells

Unique Uniform Spray
Wax Coating

Fits Frame Sizes 9 1/8" and 6 1/4"

Food Grade Plastic
Wax coated
at Hamilton, IL

Wax Moth Cannot
Damage Base

EZ Frames

1 Piece Plastic Frame and Foundation
No Assembly — No Wiring
Strong — Durable
Not Affected By Weather Conditions

Sizes 9 1/8" and 6 1/4"

Wax Coated

Now Available in Sizes 4 3/4" and 6 1/2"

BUY BEESWAX FOUNDATION MOST ECONOMICALLY WITH DADANT'S WAX WORKING PLAN FOR 25# OR MORE

WAX WORKING RATES			
Wax Working Number	Foundation Type	Working Rates per Pound	
		Min. of 25# to 100#	Over 100#
⊗ F60001	Crimp-Wired, w/top hooks	3.60	\$3.55
⊗ F60002	Crimp-Wired, no hooks	3.55	\$3.50
⊗ F60004	Medium Plain	3.35	\$3.30
⊗ F60005	Thin Surplus	3.85	\$3.80
⊗ F60006	Cut Comb	3.85	\$3.80

Call for pricing on Small Cell Wired or Medium Plain

Note: Add \$.03 per pound to figures shown for all shallow sizes (4 3/4" and below).

Please Note: Working rates for Thin Surplus and Cut Comb Foundations are based on customers providing light wax. Additional upcharges will apply if light wax is not supplied.

All prices are for 25 lb. bulk packs only. (Special sizes—200# Wax Working Minimum or Additional \$110 set-up charge applies. Small Cell orders under 200# will have a \$300.00 set up fee.)

The Dadant Company has been working wax into foundation for their customers for many years. Our wax working rates include all the many steps it takes to process your wax into the finest 100% beeswax foundation available. Careful inspection during every step of the manufacturing process, along with durable and protective packaging, insures a final product of superior quality.

Because of the low prices reflected in the working rates, we must have your beeswax before shipping foundation and do require payment for the working charge. Beeswax foundations cannot be shipped safely in cold weather. For further information on the wax working program, contact your local branch manager.

⊗ = No free shipping

ASSEMBLED FRAMES

STRENGTH where it counts!

Assembled Frames with Foundation
Carton of 10



Machine to manufacture assembled frames with foundation at our Hamilton, IL. location. Each frame is secured by ample amounts of glue along with heavy duty staples to hold frame structure.



C75210
9 1/8" GTB/GBB
Actual wt. 8 lbs.
C75210 C/10 Frames . . . \$49.50 ea.



C76210
6 1/4" GTB/GBB
Actual wt. 6.28 lbs.
C76210 C/10 Frames . . . \$47.50 ea.

9 1/8" GTB/GBB
Assembled Frames with
Coated Plasticell Foundation
Actual wt. 0.78 lbs. ea.

C75201	
1-10	\$4.65
11-49	\$3.85
50-99	\$3.50
100-249	\$3.45
250-499	\$3.35
500	Call for price 888-922-1293

6 1/4" GTB/GBB
Assembled Frames with
Coated Plasticell Foundation
Actual wt. 0.64 lbs. ea.

C76201	
1-10	\$4.35
11-49	\$3.65
50-99	\$3.35
100-249	\$3.25
250-499	\$3.10
500	Call for price 888-922-1293

On Large quantity orders prices are FOB – Call local Branch for Pricing

Contact your local branch for a quote and availability from their location.

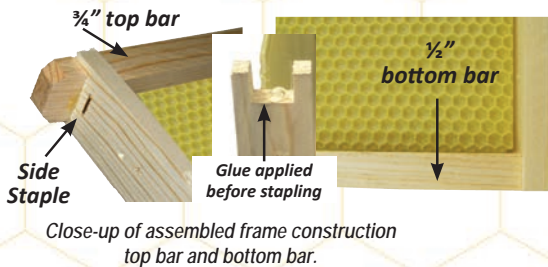

6 5/8" Painted Hive Super with White EZ Frames
Actual wt. 13.2 lbs.
C31501PEZ \$61.95

9 5/8" Painted Hive Body with White EZ Frames
Actual wt. 17.8 lbs.
C51101PEZ \$66.95

10-frame — Painted Medium Super with EZ Frames. Completely assembled commercial grade wood comes with 10 beeswax coated plastic frames and foundation. EZ Frames may be white, yellow, or black in color.

EZ FRAMES Sizes Available 9 1/8" and 6 1/4"

EZ Frames—One piece food grade plastic frame and wax coated foundation molded together for one long lasting, sturdy unit. You never have to assemble frames and foundation again. That's why it's called **EZ Frame**. Colors may vary.

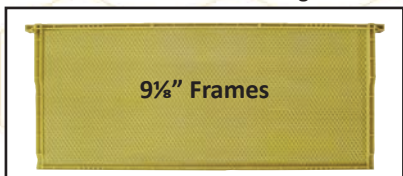

9 1/8" Frames

M58705
9 1/8" EZ Frames, each
Actual wt. 0.65 lbs.

1-10	\$4.20
11-50	\$4.00
51-100	\$3.45
101-250	\$3.30

Wax Moth Cannot Damage Base
Food Grade Plastic wax coated at Hamilton, IL

500+ Call for Quantity Pricing
On Large quantity orders prices are FOB
– Call local Branch for Pricing

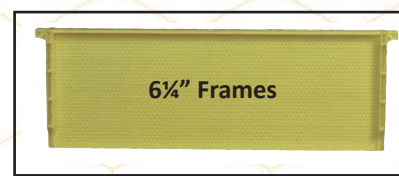

6 1/4" Frames

M58725
6 1/4" EZ Frames, each
Actual wt. 0.55 lbs.

1-10	\$4.05
11-50	\$3.75
51-100	\$3.30
101-250	\$3.10

Contact your local branch for a quote and availability from their location.

10-FRAME BEEKEEPING EQUIPMENT

HIVE BODIES, FRAMES AND FOUNDATION FOR 9 5/8" DEEP SUPERS



Hive Bodies — 9 5/8" Deep Supers						
Wood Grade (see page 3)	Nails Included		Quantity			
	Carton of 1	Carton of 5	Nails Not Included (See page 18)			
			1 - 10	11-49	50-249	250 - 499
Select	B51201 Actual wt. 9.45 lbs. \$27.95	B51205 Actual wt. 42.12 lbs. \$129.95	B50230 Actual wt. 8.86 lbs. ea. \$24.95	B50230 Actual wt. 8.86 lbs. ea. \$23.95	B50230 Actual wt. 8.86 lbs. ea. \$22.95	B50230 Actual wt. 8.86 lbs. ea. \$21.95
			B50270 Actual wt. 8.86 lbs. ea. \$21.95	B50270 Actual wt. 8.86 lbs. ea. \$17.95	B50270 Actual wt. 8.86 lbs. ea. \$16.95	B50270 Actual wt. 8.86 lbs. ea. \$13.95
Commercial			B50501 Actual wt. 8.86 lbs. ea. \$19.95	B50501 Actual wt. 8.86 lbs. ea. \$16.95	B50501 Actual wt. 8.86 lbs. ea. \$14.95	B50501 Actual wt. 8.86 lbs. ea. \$12.95
Economy						

For quantities of 500+ Call for price

Not Assembled

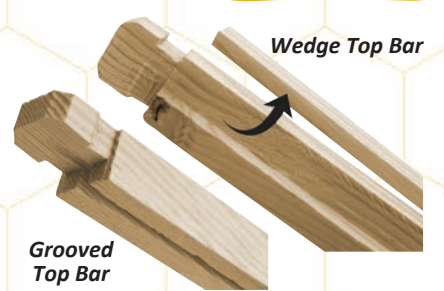

9 5/8" Frames for 9 5/8" Hive Bodies					
Frame Style (see page 3)	Nails Included		Quantity (Please order in multiples of 100)		
	Carton of 10	Carton of 50	Nails Not Included (See page 18)		
			100-400	500-4900	5000 and Up
9 5/8" Wedge Top Bar Frames	B75110 Actual wt. 4.96 lbs. \$20.95	B75150 Actual wt. 24.22 lbs. \$83.95	B85001 Actual wt. 43.85 lbs./100 \$134.95/100	B85001 Actual wt. 219.25 lbs./500 \$130.95/100	B85001 Actual wt. 2192.5 lbs./5000 \$125.95/100
	B75210 Actual wt. 4.92 lbs. \$20.75	B75250 Actual wt. 24.22 lbs. \$78.95	B85201 Actual wt. 43.82 lbs./100 \$133.95/100	B85201 Actual wt. 219.25 lbs./500 \$129.95/100	B85201 Actual wt. 2192.5 lbs./5000 \$124.95/100
9 5/8" Economy Grade (Budget) Frames	Wedge Top Bar	B850011	\$125.95/100 Actual wt. 43.82 lbs./100	\$123.95/100 Actual wt. 219.25 lbs./500	\$119.95/100 Actual wt. 2192.5 lbs./5000
	Groove Top Bar	B852011	\$125.95/100	\$123.95/100	\$119.95/100

100% U.S. Beeswax Foundation for 9 5/8" Frames See Wax Working Rates—Page 11

Foundation Type (see page 11)	Size	Frame Style Used In	Item Number	Sheets Per Lb.*	Quantity Per Carton	Actual Weight	Price Per Carton
Crimp Wired	fits 9 5/8" frame 8 1/2 x 16 3/4	Wedge Top Bar Only	F35010	7	10 sheets	1.75 lbs.	\$22.75
			F35050	7	50 sheets	7.95 lbs.	\$88.95
			F35000	7	25 lbs.	29.08 lbs.	\$262.95
Plain no wire (Medium Brood)	fits 9 5/8" frame 8 1/2 x 16 3/4	Wedge or Grooved Top Bar	F35001	7	25 lbs.	29.08 lbs.	\$262.95
			F38410	7	10 sheets	1.7 lbs.	\$22.75
			F38450	7	50 sheets	7.95 lbs.	\$88.95
			F38400	7	25 lbs.	28.35 lbs.	\$249.95

BELOW 38 DEGREES SHIPS AT BUYER'S RISK.

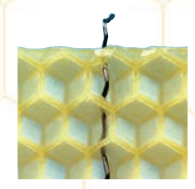

Crimp Wired

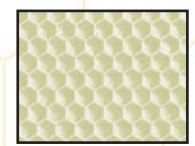

Plain no wire (Medium Brood)

Plasticell—Plastic Foundation for 9 5/8" Frames Available in Black or Yellow

Plasticell Available in Yellow or Black	fits 9 5/8" frame 8 1/2 x 16 3/4	Sheet Quantity	Actual Weight		F36000 Yellow Uncoated F36000B Black Uncoated	F37000 Yellow Wax Coated F37000B Black Wax Coated	F37000DC Yellow Wax Double Coated F37000BDC Black Wax Double Coated
			Uncoated	Wax Coated			
Wedge Top Bar or Grooved Top Bar		1-10	2.8#/10	3.5#/10	Call	\$2.25	\$2.55
		11-99	14#/50	17.5#/50	Call	\$1.95	\$2.25
		100-999	28#/100	35#/100	Call	\$1.85	\$2.15
		1000-1999	280#/1000	350#/1000	Call	\$1.75	\$2.05
		2000	560#/2000	700#/2000	Call	\$1.65	\$1.95

For quantities of 3000+ Call for price 1-888-922-1293



Black Plasticell



Yellow Plasticell

*Sheets per lb. are approximate and may vary in the manufacturing process.
Special Supers, Frames, Foundation and Frame Parts Available CALL FOR QUOTE 1-888-922-1293
While we hope to maintain prices at all locations, escalating freight costs may necessitate occasional adjustments.

10-FRAME BEEKEEPING EQUIPMENT

SUPERS, FRAMES AND FOUNDATION FOR 6⁵/₈" SUPERS



For quantities of 500+ Call for price

Not Assembled

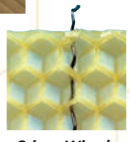
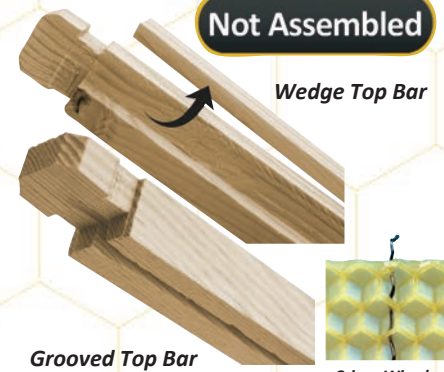

Plain no wire (Medium Brood)



Cut Comb

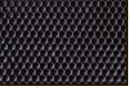

Black Plasticell



Yellow Plasticell

6⁵/₈" Dadant Depth Honey Supers

Wood Grade (see page 3)	Nails Included		Quantity			
	Carton of 1	Carton of 5	Nails Not Included (See page 18)			
			1-10	11-49	50-249	250 - 499
Select	B31201 <small>Actual wt. 5.85 lbs.</small> \$25.95	B31205 <small>Actual wt. 28.85 lbs.</small> \$118.95	B31500 <small>Actual wt. 5.28 lbs. ea.</small> \$23.95	B31500 <small>Actual wt. 5.28 lbs. ea.</small> \$22.95	B31500 <small>Actual wt. 5.28 lbs. ea.</small> \$21.95	B31500 <small>Actual wt. 5.28 lbs. ea.</small> \$20.95
			B34100 <small>Actual wt. 5.28 lbs. ea.</small> \$19.95	B34100 <small>Actual wt. 5.28 lbs. ea.</small> \$15.95	B34100 <small>Actual wt. 5.28 lbs. ea.</small> \$14.95	B34100 <small>Actual wt. 5.28 lbs. ea.</small> \$12.95
Commercial			B34201 <small>Actual wt. 5.28 lbs. ea.</small> \$17.95	B34201 <small>Actual wt. 5.28 lbs. ea.</small> \$14.95	B34201 <small>Actual wt. 5.28 lbs. ea.</small> \$12.95	B34201 <small>Actual wt. 5.28 lbs. ea.</small> \$10.95

6¹/₄" Frames for above 6⁵/₈" Honey Supers

Frame Style (see page 3)	Nails Included		Quantity (Please order in multiples of 100)		
	Carton of 10	Carton of 50	Nails Not Included (See page 18)		
			100-400	500-4900	5000 and Up
6 ¹ / ₄ " Wedge Top Bar Frames	B76110 <small>Actual wt. 4.3 lbs.</small> \$18.95	B76150 <small>Actual wt. 21.68 lbs.</small> \$79.95	B85003 <small>Actual wt. 40.3 lbs./100</small> \$134.95/100	B85003 <small>Actual wt. 201.5 lbs./500</small> \$130.95/100	B85003 <small>Actual wt. 2015 lbs./5000</small> \$125.95/100
	B76210 <small>Actual wt. 4.3 lbs.</small> \$18.50	B76250 <small>Actual wt. 21.52 lbs.</small> \$77.95	B85203 <small>Actual wt. 40.3 lbs./100</small> \$133.95/100	B85203 <small>Actual wt. 201.5 lbs./500</small> \$129.95/100	B85203 <small>Actual wt. 2015 lbs./5000</small> \$124.95/100
6 ¹ / ₄ " Grooved Top Bar Frames					
6 ¹ / ₄ " Economy Grade (Budget) Frames	Wedge Top Bar	B850031	\$125.95/100	\$123.95/100	\$119.95/100
	Groove Top Bar	B852031	\$125.95/100	\$123.95/100	\$119.95/100

100% U. S. Wax Foundations for 6¹/₄" Frames Wax Working Rates—Page 11

Foundation Type (see page 11)	Size	Frame Style Used In	Item Number	Sheets Per Lb. *	Quantity Per Carton	Actual Weight	Price Per Carton
Crimp Wired	fits 6 ¹ / ₄ " frame 5 ¹ / ₂ x 16 ³ / ₄	Wedge Top Bar Only	F35310	11	10 sheets	1.8 lbs.	\$18.95
			F35350	11	50 sheets	5.55 lbs.	\$64.95
			F35300	11	25 lbs	28.95 lbs.	\$267.95
	no hook	Wedge or Grooved Top Bar	F35301	11	25 lbs	28.95 lbs.	\$262.95
Plain no wire (Medium Brood)	fits 6 ¹ / ₄ " frame 5 ¹ / ₂ x 16 ³ / ₄	Wedge Top Bar	F38610	11	10 sheets	1.2 lbs.	\$18.95
			F38650	11	50 sheets	5.1 lbs.	\$63.95
			F38600	11	25 lbs	28.95 lbs.	\$268.95
Cut Comb	fits 6 ¹ / ₄ " frame 5 ¹ / ₂ x 16 ¹ / ₂	Wedge Top Bar	F32301	16	1 lbs	1.25 lbs.	\$24.95
			F32305	16	5 lbs	5.95 lbs.	\$92.95
			F32300	16	25 lbs	26 lbs.	\$306.95

BELOW 38 DEGREES SHIPS AT BUYER'S RISK.

Plasticell—Plastic Foundation for 6¹/₄" Frames Available in Black or Yellow

Plasticell	fits 6 ¹ / ₄ " frame 5 ¹ / ₂ x 16 ³ / ₄	Frame Style Used In	Sheet Quantity	Actual Weight			F36200	F37200	F37200DC
				Uncoated	Wax Coated	Double Coated	Yellow Uncoated F36200B Black Uncoated	Yellow Coated F37200B Black Coated	Yellow Double Coated F37200BDC Black Double Coated
Uncoated or Beeswax Coated	Wedge Top Bar or Grooved Top Bar	1-10	2#/10	2.5#/10	3.6#/10	Call	\$2.00	\$2.30	
		11-99	10#/50	12.5#/50	18#/50	Call	\$1.80	\$2.10	
		100-999	20#/100	25#/100	36#/100	Call	\$1.70	\$2.00	
		1000-1999	200#/1000	250#/1000	360#/1000	Call	\$1.55	\$1.90	
		2000	400#/2000	500#/2000	720#/2000	Call	\$1.45	\$1.75	

For quantities of 3000+ Call for price

*Sheets per lb. are approximate and may vary in the manufacturing process.

Special Supers, Frames, Foundation and Frame Parts Available CALL FOR QUOTE

While we hope to maintain prices at all locations, escalating freight costs may necessitate occasional adjustments.

10-FRAME BEEKEEPING EQUIPMENT

SUPERS, FRAMES AND FOUNDATION FOR 5¹¹/₁₆" SUPERS



Not Assembled

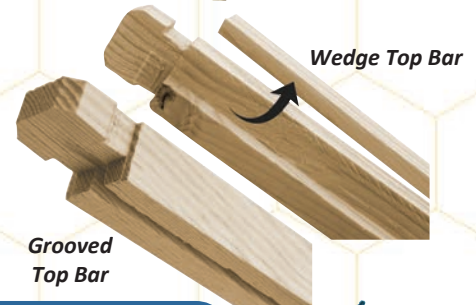

5 ¹¹ / ₁₆ " Shallow Supers For quantities of 500+ Call for price						
Wood Grade (see page 3)	Nails Included		Quantity Nails Not Included (See page 18)			
	Carton of 1	Carton of 5	1-10	11-49	50-249	250 - 499
Select	B32201 Actual wt. 5.2 lbs. \$24.95	B32205 Actual wt. 25.34 lbs. \$115.95	B32500 Actual wt. 5.12 lbs. ea. \$23.95	B32500 Actual wt. 5.12 lbs. ea. \$22.95	B32500 Actual wt. 5.12 lbs. ea. \$21.95	B32500 Actual wt. 5.12 lbs. ea. \$20.95
Commercial			B34400 Actual wt. 5.12 lbs. ea. \$19.20	B34400 Actual wt. 5.12 lbs. ea. \$15.20	B34400 Actual wt. 5.12 lbs. ea. \$14.20	B34400 Actual wt. 5.12 lbs. ea. \$11.20
Economy			B34601 Actual wt. 5.12 lbs. ea. Call	B34601 Actual wt. 5.12 lbs. ea. Call	B34601 Actual wt. 5.12 lbs. ea. Call	B34601 Actual wt. 5.12 lbs. ea. Call

5 ³ / ₈ " Frames for above Shallow Supers					
Frame Style (see page 3)	Nails Included		Quantity (Please order in multiples of 100) Nails Not Included (See page 18)		
	Carton of 10	Carton of 50	100-400	500-4900	5000 and Up
5³/₈" Wedge Top Bar Frames	B77110 Actual wt. 4.48 lbs. \$18.95 each	B77150 Actual wt. 21.62 lbs. \$79.95 each	B85004 Actual wt. 38.78 lbs./100 \$134.95/100	B85004 Actual wt. 193.90 lbs./500 \$130.95/100	B85004 Actual wt. 1939 lbs./5000 \$125.95/100
5³/₈" Grooved Top Bar Frames			B85204 Actual wt. 38.78 lbs./100 \$133.95/100	B85204 Actual wt. 193.90 lbs./500 \$129.95/100	B85204 Actual wt. 1939 lbs./5000 \$124.95/100
5³/₈" Economy Grade (Budget) Frames	Wedge Top Bar Groove Top Bar	B850041 B852041	Call Actual wt. 38.78 lbs./100	Call Ship wt. 193.90 lbs./500	Call Ship wt. 1939 lbs./5000

100% Wax Foundations for 5 ³ / ₈ " Frames See Wax Working Rates — Page 11							
Foundation Type (see page 11)	Size	Frame Style Used In	Item Number	Sheets Per Lb.*	Quantity Per Carton	Actual Weight	Price Per Carton
Crimp Wired	fits 5 ³ / ₈ " frame 4 ³ / ₄ x 16 ³ / ₄	Wedge Top Bar Only	F35210	12	10 sheets	1 lbs.	\$17.95
			F35250	12	50 sheets	4.75 lbs.	\$63.95
	F35200	12	25 lbs.	29 lbs.	\$262.95		
Plain no wire (Medium Brood)	fits 5 ³ / ₈ " frame 4 ³ / ₄ x 16 ³ / ₄	Wedge Top Bar	F38310	13	10 sheets	1.05 lbs.	\$18.95
			F38350	13	50 sheets	4.75 lbs.	\$63.95
			F38300	13	25 lbs.	26 lbs.	\$268.95
**Cut Comb	fits 5 ³ / ₈ " frame 4 ³ / ₄ x 16 ³ / ₂	Wedge Top Bar	F32201	18	1 lb.	1.3 lbs.	\$24.95
			F32205	18	5 lbs.	5.85 lbs.	\$91.95
			F32200	18	25 lbs.	26 lbs.	\$318.95
**Thin Surplus	fits 5 ³ / ₈ " frame 4 ³ / ₄ x 16 ³ / ₂	Wedge Top Bar	F31401	22	1 lb.	1.3 lbs.	\$23.95
			F31405	22	5 lbs.	5.9 lbs.	\$99.95
			F31400	22	25 lbs.	26 lbs.	\$306.95

BELOW 38 DEGREES SHIPS AT BUYER'S RISK.

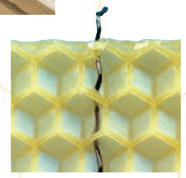

Crimp Wired



Plain no wire (Medium Brood)

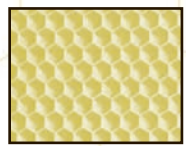

Cut Comb

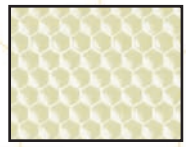

Thin Surplus



Yellow Plasticell

Plasticell—Plastic Foundation FOR 5 ³ / ₈ " Frames							
Plasticell	Fits 5 ³ / ₈ " frame 4 ³ / ₄ x 16 ³ / ₄	Frame Style Used In	Sheet Quantity	Ship Weight		F36300	F37300
				Uncoated	Wax Coated	Uncoated	Wax Coated
Uncoated or Beeswax Coated		Wedge Top Bar or Grooved Top Bar	1-10	1.6#/10	2#/10	Call	\$2.00
			11-99	8#/50	10#/50	Call	\$1.80
			100-999	16#/100	20#/100	Call	\$1.70
			1000-1999	160#/1000	200#/1000	Call	\$1.55
			2000	320#/2000	400#/2000	Call	\$1.45

For quantities of 3000+ Call for price

While we hope to maintain prices at all locations, escalating freight costs may necessitate occasional adjustments.

*Sheets per lb. are approximate and may vary in the manufacturing process.

**Preferred for cut Comb Honey and Chunk Honey. 4³/₄" foundation is available—Call for Prices. Special Supers, Frames, Foundation and Frame Parts Available CALL FOR QUOTE 1-888-922-1293

FOUNDATION FOR VARROA CONTROL

One piece drone frames come beeswax coated and are available in 9/8" and 6 1/4" depths. Comes in neon green color to help you easily identify drone combs.



M58725D

6 1/4" Drone Comb

M58725D 6 1/4" coated drone comb
Actual wt. 0.55 lbs. ea., 1-10. **\$4.80**



M58701D

9/8" Drone Comb

M58701D 9/8" coated drone comb
Actual wt. 0.75 lbs. ea., 1-10. **\$4.95**



Varroa Mite on Honey Bee

The **Varroa Mite** is, without a doubt, the most serious parasite of honey bees in North America. Ignoring treatment of colonies infested with Varroa mites will result in colony death in 1 to 2 years. Most honey bee colonies in North America are infested with Varroa mites.



Varroa Mite



Actual Size

Dadant Small Cell Beeswax Foundation 4.9 & 5.1

Many beekeepers believe that varroa mites have a difficult time reproducing on worker brood raised in small cell comb. So, if you are an experienced beekeeper who has an experimental nature, this may be an opportunity for you to move ahead of the chemical control crowd with your honey bee management.

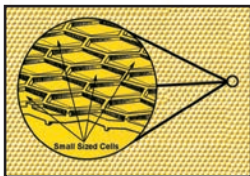

WHY A 5.1?

Many recommend a transition from the standard 5.4 to the 4.9 cell foundation allowing the bees to adjust more readily and help avoid the erratic comb drawing that can occur with a direct downsizing from the 5.4 to the 4.9 — thus a middle step with the 5.1.

AVAILABLE IN PLAIN AND WIRED

8 1/2 x 16 1/4 Plain Small Cell 4.9mm Beeswax Foundation

F46010SC 10 Sheets Per Package
Actual wt. 1.75 lbs. ea. **\$23.95**

F46050SC 50 sheets
Actual wt. 8.05 lbs. ea. **\$94.95**

F46000SC 25 lbs.
Actual wt. 26 lbs. ea. **\$269.95**
(Approx. 7 sheets per lb.)

8 1/2 x 16 1/4 LH Wired Small Cell 4.9mm Beeswax Foundation

F350103SC 10 Sheets Per Package
Actual wt. 1.75 lbs. ea. **\$23.95**

F350503SC 50 sheets
Actual wt. 7.95 lbs. ea. **\$94.95**

F350003SC 25 lbs.
Actual wt. 29.08 lbs. ea. **\$269.95**
(Approx. 7 sheets per lb.)

8 1/2 x 16 1/4 LH Wired Small Cell 5.1mm Beeswax Foundation

F350103SC5 10 Sheets Per Package
Actual wt. 1.75 lbs. ea. **\$23.95**

F350503SC5 50 sheets
Actual wt. 7.95 lbs. ea. **\$94.95**

F350003SC5 25 lbs.
Actual wt. 29.08 lbs. ea. **\$269.95**
(Approx. 7 sheets per lb.)

5 3/8 x 16 1/4 LH Wired Small Cell 4.9mm Beeswax Foundation

F353103SC 10 Sheets Per Package
Actual wt. 1.35 lbs. ea. **\$23.95**

F353503SC 50 sheets
Actual wt. 5.23 lbs. ea. **\$94.95**

F353003SC 25 lbs.
Actual wt. 28.95 lbs. ea. **\$269.95**
(Approx. 7 sheets per lb.)

5 3/8 x 16 1/4 LH Wired Small Cell 5.1mm Beeswax Foundation

F353103SC5 10 Sheets Per Package
Actual wt. 1.2 lbs. ea. **\$23.95**

F353503SC5 50 sheets
Actual wt. 5.25 lbs. ea. **\$94.95**

F353003SC5 25 lbs.
Actual wt. 28.95 lbs. ea. **\$269.95**
(Approx. 7 sheets per lb.)

Drone Cell Foundation

By using a few frames of drone comb, you can lure Varroa mites to the developing drone brood, and the mites become trapped within the drone cell when the bees cap the cells. Remove the frame of capped drone cells. Put it in a plastic bag in your freezer overnight to kill the mites. Remove from the freezer and let warm. With the cappings scratcher (page 77), break open the drone cells. Then, put the frame back into the colony and allow the worker bees to clean out the cells, getting rid of the dead varroa mites and drones. After the queen lays drone eggs in these cells again, this Varroa trapping cycle is repeated.

F45010 8 1/2 x 16 1/4 Non-wire (Drone Comb) Foundation
10 Sheets Per Package, Actual wt. 1.8 lbs. ea. **\$23.95**

F45050 50 sheet Non-wire (Drone Comb) Foundation
Actual wt. 7.95 lbs. ea. **\$94.95**

F45000 20 lb. Non-wire (Drone Comb) Foundation
Actual wt. 22 lbs. (Approx. 7 sheets per lb.) ea. **\$269.95**

FRAME/FOUNDATION HARDWARE

Cross-wiring is necessary to firmly hold some foundations in place. For example, we recommend 4 cross-wires when using 8½" medium brood foundation, but only 2 for holding 8½" crimp wire foundation. Beekeepers even find it advantageous to put one cross-wire in bulk comb foundation — then pulling out the cross-wire from the end of the frame prior to cutting the bulk comb. To prevent the wire from cutting into the frame end bars, we recommend using eyelets to protect the frames.

Grooved Spur Embedder

This is another style of spur embedder. It has a groove between the wheels that will help make the job easier. *Cannot be used with crimped frame wire.*

M00721 Grooved Spur Embedder,
Actual wt. 0.12 lbs. **\$13.95**

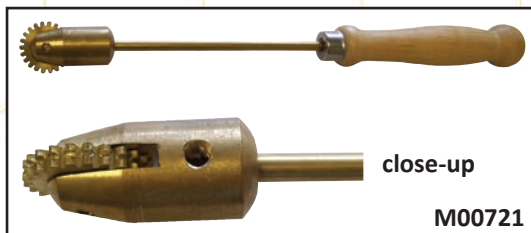

Spur Embedder

Uses hand pressure to fasten wire in any foundation needing horizontal wires for added support. Roll the wide-tooth spur points along each wire. May be used warm (preferable) or cold. Many beekeepers purchase two — keep one heating while the other is in use.

M00703 Spur Embedder, Actual wt. 0.2 lbs. ea. **\$14.05**

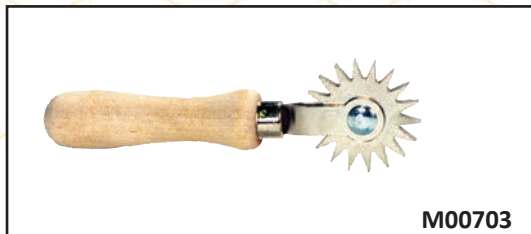

Wire Crimper

Support your wax foundation by tightening and crimping your frame wire with our wire crimper. Helps give wax foundation the extra support it needs.

M01943 Wire Crimper,
Actual wt. 0.1 lbs. **\$14.05**

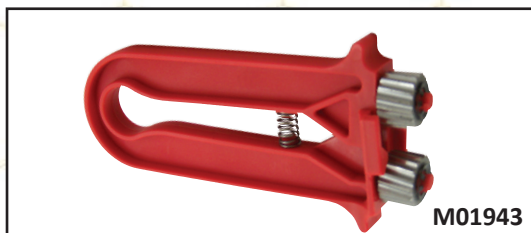

Brass Eyelets

Small brass eyelets are punched into the wiring holes in end bars of brood and super frames. Prevents wire from cutting into the wood. Keeps horizontal wires tight. Special punch makes insertion simple and easy. Sold separately.

M00709 1000 Eyelets, Actual wt. 0.19 lbs. **\$12.75**

M00710 5000 Eyelets, Actual wt. 0.96 lbs. **\$49.95**

M00711 Punch, Actual wt. 0.05 lbs. **\$5.95**

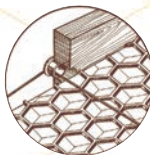

Frame Wire

Top grade tinned wire made especially for the bee industry with great tensile strength. Should always be used for horizontal wiring brood or extracting frames in which plain or unwired foundation is to be used. May also be used with crimp-wired foundation to gain even greater strength. This wire is 26 gauge.

M00705 ½ lb. Spool, Actual wt. 0.82 lbs. **\$9.45**

M00706 1 lb. Spool, Actual wt. 1.49 lbs. **\$13.95**

M00707 5 lb. Spool, Actual wt. 5.4 lbs. **\$38.95**



Frame/Form Board

For use with 9⅞", 6¼" and 5⅜" frames. This is a useful tool for nailing frame wedges and inserting foundation in frames. It is a good companion for the spur embedder **M00721** or **M00703** (shown above). It supports the frame with foundation while embedding. May also be used for hand-wiring frames.

B10301 Form Board, Actual wt. 1.9 lbs. **\$17.95**



Electric Embedder and Transformer — Sold Separately —

This embedder, used with the 12 volt transformer shown below, heats horizontal frame wire so it is well-attached, but does not mar the foundation. Embeds one wire at a time.

M00701 Embedder Only, Actual wt. 0.55 lbs. **\$73.60**

M00702 12 Volt Transformer Only, Actual wt. 2.99 lbs. **\$79.25**



NAILS, RABBETS AND SUPPORT PINS

Plastic Support Pins

Slip the pin in the holes on the end bar and slide the sheet of foundation in to securely hold it in place. Minimum of two per end bar. Carton of 100. Actual wt. 0.05 lbs.

M01755 c/100 pins \$16.95

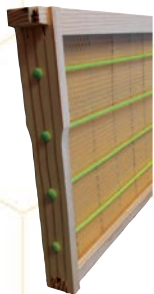
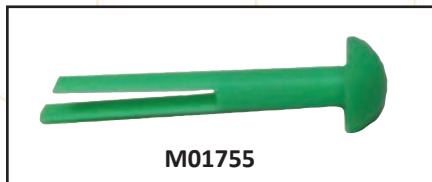

Plastic Rods

Support Rods — Sick of cross-wiring frames? These support rods slide through the holes in the end bars and are locked in place. Wire your frames in seconds.

M0175410 c/10 rods, Actual wt. 0.1 lbs. \$6.95

Support Pins

Support pins are small metal pins similar to clothespins. Simply press these pins through the holes in the frame end bars so foundation is held in pin slot. For many, especially beginning beekeepers using crimp wired foundation in brood chambers, support pins are much easier to use than the sometimes tedious cross wiring to prevent foundation sagging. Cannot be used with Plasticell foundation.

M00819 200 pins, Actual wt. 0.44 lbs. \$24.95

M00820 1000 pins, Actual wt. 2.25 lbs. \$106.95

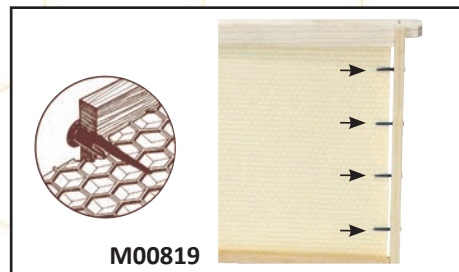

Showing correct placement of staples

Nails for Frame and Super Assembly

For nailing frame top bars to end bars and for bottom bars to end bars use **M00727** (1¼"). For nailing wedges use **M00726** (¾"). For nailing hive bodies and supers, we recommend **M00731**, 7d (2¼") galvanized nails. For nailing bottom boards we recommend **M00730**, 4d (1½") galvanized nails.

*For shipping weight add 2 lbs. to quantity ordered up to 100 lbs. and add 5 lbs. over 100 lbs.

Item Number	Size and Description	Approx. Qty./lb.	Quantity Price/lb.*
M00726	¾" x 18 gauge	2600	\$13.50
M00727	1¼" x 17 gauge	1150	\$10.50
M00730	4d galvanized	460	\$9.05
M00731	7d galvanized	180	\$6.95

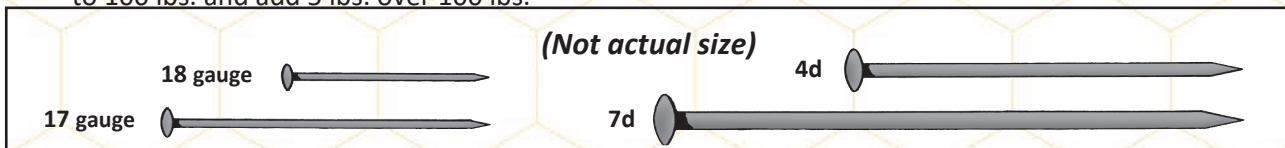

9⅝" Hive Bodies/Deep Supers			6⅝" Supers			Frames		
Nail Size	Nails needed per hive body/deep super	1# of nails will make	Nail Size:	Nails needed per 6⅝" super	1# of nails will make	Nail Size:	Nails needed per frame	1# of nails will make
7D M00731	36	5 Hive Bodies	7D M00731	24	7 Supers	¾" M00726	4 nails for wedge only	650 Frames
4D M00730	4	115 Hive Bodies	4D M00730	4	115 Supers	1¼" M00727	10	115 Frames

Metal Rabbits (frame rests)

Metal Rabbits protect frame rests in your supers. Light gauge pre-punched and pre-bent metal parts fit over frame rests and nail into place. These metal parts increase the life of your supers and ease super cleaning by protecting the wooden frame rests during cleaning. Actual wt. 0.05 lbs. ea.

M00722 L-Shaped Rabbet 1-99 \$.50

L-Shaped Rabbet 100-999 ea. \$.40

L-Shaped Rabbet 1000 & over ea. \$.35

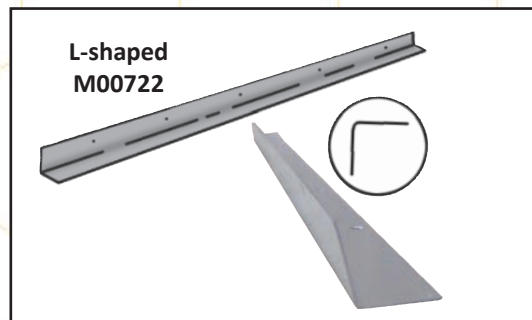

10-FRAME HIVE STANDS AND LANDING BOARDS



Cypress Bottom Board with West Trap, Landing Board and IPM Board

This ultimate bottom board does it all. Made of Cypress this all-in-one bottom board will trap and kill SHB, allow you to check for mites with the IPM board, and give your bees a landing board to land on when coming back from foraging. Comes complete with west beetle trap and IPM board. Fully Assembled.

M60040 10-Frame Cypress Bottom Board, Actual wt. 5.5 lbs. \$43.95

M60045 8-Frame Cypress Bottom Board, Actual wt. 4.25 lbs. \$43.95

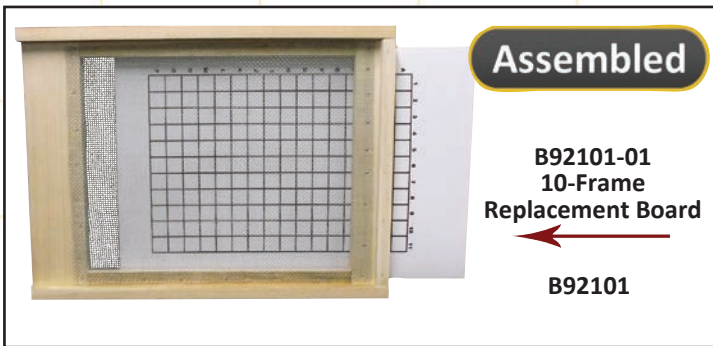

Screen IPM Board

This integrated pest management bottom board comes complete with Varroa monitoring board. Access the screen from front of the hive below the bottom board. Leave the monitoring board out when not monitoring Varroa levels to provide extra ventilation and allow mites to fall through to the ground.

B92101 10-Frame, Actual wt. 3.08 lbs. \$29.65

5+ \$27.65

B921018 8-Frame, Actual wt. 2.76 lbs. \$29.65

5+ \$27.65

Replacement Boards

B92101-01 10-Frame, Actual wt. 0.34 lbs. ea \$7.95

5+ \$7.75

B921018-01 8-Frame, Actual wt. 0.28 lbs. ea \$7.95

5+ \$7.75



10-Frame Ultimate Pine Hive Stand with West Beetle Trap & IPM Board

Made of pine, this all in one painted bottom board will trap and kill SHB, allow you to check for mites with the included IPM board, and gives your bees a landing board to land on.

Assembled/Painted

M60090 Actual wt. 5.5 lbs. \$46.95



Ponderosa Pine Bottom Board

The standard 10-frame bottom board is the floor of the hive and is an essential part of the hive. It provides the hive entrance and proper spacing for the bees to work. Reversible feature allows full 3/4" summer entrance or 3/8" entrance when reversed for winter. Unassembled. *Nails included - standard only.

B91101 Standard, c/1, Actual wt. 6.56 lbs. \$23.95*

B91105 Standard, c/5, Actual wt. 28.56 lbs. \$96.95*

B91201 Commercial, 50-249, Actual wt. 6.56 lbs. . . . \$17.95

Commercial, 250+ \$16.50

10-FRAME HIVE STANDS AND LANDING BOARDS

Dadant Stainless Hive Stand



Dadant-made Stainless Steel Hive Stands sleek design is perfect for all types of apiaries. From a single hive operation to a 20 colony out yard, these stands are made to last. Ships knocked down. Easy to assemble.

M00698 Dadant Stainless Hive Stand, Actual wt. 7.5 lbs. **\$89.00**

AntCant

The AntCant, ant barrier coating (patent pending) was scientifically developed to be a non-toxic, low maintenance deterrent from ant infestation. The coating works by preventing the ants from attaching to an inclined coated surface. Since they can't get a grip, they fall off and do not make it to the attractant (food, garbage, etc.) After being discouraged the ants give up and leave! Once the ants know the barrier is in place they don't seem to even re-challenge it! Includes 3.5 oz. bottle and a roll of 2" aluminum tape.

M001440 AntCant 3.5 oz. bottle, Actual wt. 0.5 lbs. **\$29.95**



Ultimate Hive Stand Deluxe Model

The Ultimate Hive Stand Deluxe Model is the only hive stand you will ever need. It has a classic design that is fully functional and looks great in any apiary or garden. It has swing out frame holders to make working the hive easier and when not in use will fold up out of the way. The stand raises the hive 12 inches off the ground for easier access and better ventilation. It works with any bottom board and no wooden hive stand is needed. It is fast and easy to assemble, usually taking less than 2 minutes with a screwdriver. It is made from recycled materials.

M01693 10-frame Ultimate Hive Stand Deluxe Model, Actual wt. 8.9 lbs. ea. **\$94.95**

M01696 10-frame Beemax Deluxe Hive Stand, Actual wt. 9.8 lbs. ea. **\$106.95**



Unassembled Hive Stand 10-Frame

To eliminate moisture problems and provide insulation, it is important to keep the hive from making contact with the ground. This durable wood hive stand protects the hive bottom board and gives bees an angled landing area. **Unassembled.**

M00695 Actual wt. 3.06 lbs. **\$19.95**

M00696 Carton of 5, Actual wt. 15.3 lbs. **\$89.95**

Slatted Rack

You asked for it and here it is. The slatted rack sits in between your bottom board and brood box, providing ventilation and extra space for the bees. The additional room provided when using the slatted rack is thought to help reduce swarming. Frames line up with the slats so varroa will fall through the screens in your bottom boards.

B91401 10-frame, Actual wt. 3.5 lbs. **\$28.95**

5+ **\$26.95**



10-FRAME TOP COVERS

Telescoping Cover with Inner Cover

A strong, rigid cover with full thickness interlocking side rims. Interlocking ends are pre-drilled for easy handling. A heavy galvanized metal top has all four edges turned down to protect the edges of the wood. Metal top has pre-punched holes for nailing. This entire cover “telescopes” down over the inner cover and a portion of the top super. An inner cover is included. Unassembled. 10-Frame



B11101 Actual wt. 9.25 lbs. ea. \$48.95

B11105 Carton of 5, Actual wt. 41.9 lbs. ea. \$224.95
10+ Cartons of 5. CALL

B10002 Metal Tops, 1-99, Actual wt. 1.88 lbs. ea. \$13.95
Metal Tops, 100+ \$12.95

C11001P Assembled/Painted Tele Cover (only)
Actual wt. 6.45 lbs. each \$44.95

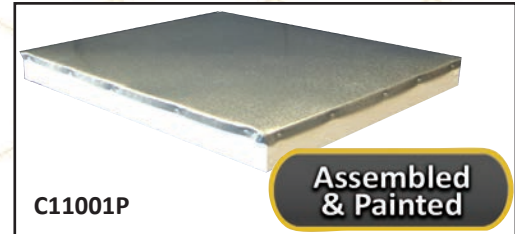

BeeMax Style Insulated Telescoping Cover (For wooden hives only)

The same style insulating cover used on our BeeMax Hive. For standard 10-frame Langstroth Hive. Upgrade your current wooden hive. Made of polystyrene, it is cooler in summer, warmer in the winter. Helps your honey bees in raising brood and collecting nectar instead of heating or cooling the hive. Actual wt. 1.82 lbs. ea.



M59301 10-Frame, 1-4, \$26.95 ea.
5-49..... \$25.95 ea.
50+ \$24.95 ea.



Assembled Plywood Migratory Cover

Our plywood Migratory cover fits standard 10-frame boxes. No inner cover needed. Rim underneath provides the correct bee space and a place to feed pollen sub patties.

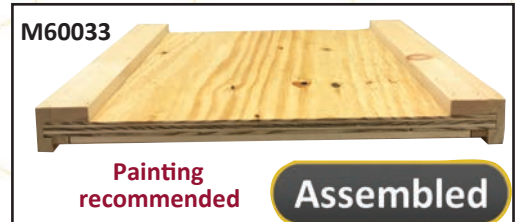

M60033 10-Frame, Actual wt. 6.8 lbs. \$15.95

Unassembled Flat Wood Cover

The most economical commercial grade cover made from Ponderosa pine. Tongue and groove construction for a tight fit and a strong cover. **Nails not included.** May not always be available at all locations. Actual wt. 5.66 lbs.



B14201 10-Frame, 1-49 \$18.25 ea.
50-249..... \$16.95 ea.
250+ \$15.95 ea.

Ultimate Hive Cover

The Ultimate Hive Cover is a self-ventilating, insulated, telescoping 10-frame cover. Made from recycled material, no assembly or painting required. Technopolymer construction will not rot. Double wall construction with dead air zone insulates the hive, cooler in summer and warmer in winter.



M01605 10-Frame, Actual wt. 3.04 lbs. \$41.75 ea.

M01605-08 Adaptor for 8-Frame, Actual wt. 0.05 lbs. \$3.99 ea.

10-FRAME INNER COVERS

Ultimate Insulated Inner Hive Cover

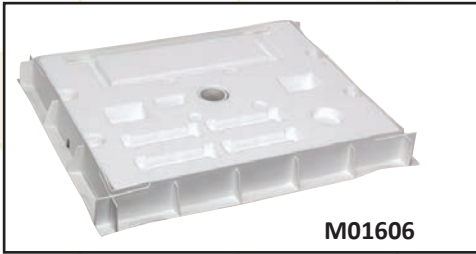

M01606

The Ultimate Inner Hive Cover reduces energy demand for healthier and happier bees that produce more honey and over winter more successfully. Multiple wintering entrance options to fit any apiary need. Part of a complete modular/component system of beekeeping products. Actual wt. 3.15 lbs.

M01606 \$32.50

Super Shim

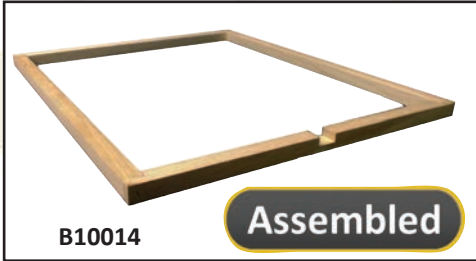

B10014

Assembled

The super shim is to be used only when your honey supers have been completely drawn out. Place shim above your queen excluder and below your honey super to give the bees an upper entrance / exit from the honey supers.

Note: Bees will burr comb in the space from bottom of shim to bottom of super should you leave it on too long.

B10014 10-Frame, Actual wt. 0.55 lbs. \$7.25
5+ \$6.75

Assembled Inner Cover Only



B15201

Assembled

Masonite Inner Cover - Mortise and tenon wood frame construction with sturdy masonite inner liner set in grooves. Will not shrink out of shape. Strong and durable. Designed to last a long time and work properly by providing correct bee working space and good hive ventilation. Use with bee escape to remove bees from supers.

B15201 10-Frame, Actual wt. 2.65 lbs. \$19.75
B15205 10-Frame, Ctn/5 1-9, Actual wt. 11.35 lbs. \$82.50
Ctn/5 10+ CALL

Assembled Ventilated Inner Cover



B15501

Assembled

Use our vented inner cover to up honey production and increase ventilation throughout the hive.

B15501 10-Frame, Actual wt. 1.25 lbs. \$19.50 ea.

Plywood Inner Cover with Feeder Hole



M60055

Jar not included

Notched Upper Entrance

Assembled

These inner covers work great to feed your colonies while keeping pesky critters including robbing bees away. Place an empty hive body on top to act as a shell and then your telescoping cover. Use a standard Boardman feeder cap in hole with a quart or 5 lb. jar of syrup.

M60055 10-Frame, Actual wt. 2.05 lbs. \$20.95 ea.

Clear Dome Cover 10-Frame



M01610

Clear Dome Cover for your beehive. This cover allows you to see the activity in the hive without having to open the hive. Perfect for visitors to see the active honey bees moving on the frames or feeding on a feeder in your hive. The people who are curious about the beehive but are nervous about the honey bees can see the action without disturbing the honey bees.

M01610 10-Frame, Actual wt. 0.45 lbs. \$19.95

10-FRAME EXCLUDERS

Wood Bound Excluder

The wood bound 10-frame excluder fits a standard hive. Electrically welded, precisely spaced metal wires make the grid system that is edged (bound) on all sides with quality fitted wood. Easy to use and remove. Provides proper bee spaces.

- B41101** 1 Wood Bound Excluder,
Actual wt. 2.84 lbs. **\$20.95**
- B41110** 10 Wood Bound Excluders,
Actual wt. 25.18 lbs. per 10 **\$195.95**



Assembled



B41101

Metal Bound Excluder

The metal bound excluder has the same precisely spaced welded wires as the wood bound excluder. This wire grid is edged (bound) with metal on all edges.

- M00823** Metal Bound Excluder, 10-Frame
1-49, Actual wt. 2.4 lbs. ea. **\$11.95 ea.**
50-499 **\$10.95ea.**
500+ **\$9.10ea.**

For 8-Frames see page 30.

Closeup of metal bound excluder construction. Heavy duty rivets to hold frame.

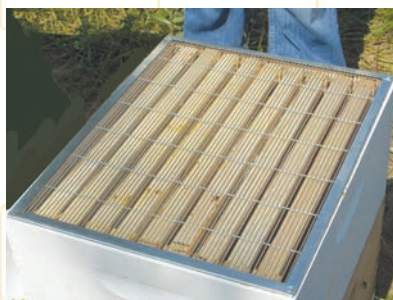

Hive not included

Metal Bound Excluder shown on hive



M00823

Improved Plastic Excluder

This excluder is all plastic with properly sized openings for the worker bees to travel through. Flexible and durable. Easy to clean, corrosion proof.

- M00865** Plastic Excluder, 10-Frame, Actual wt. 0.6 lbs. ea,
1-9 **\$6.65**
10-49 **\$6.05**
50-499 **\$5.50**
500+ **\$4.60**

For 8-Frames see page 30.

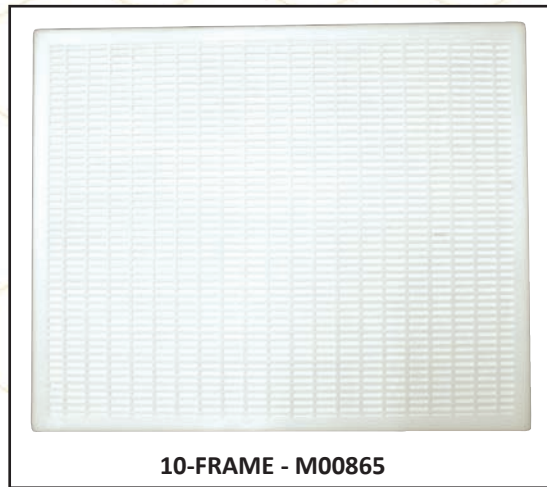

10-FRAME - M00865

Entrance Excluder

The entrance excluder will keep your queen and drone bees inside the hive. Useful tool when seeing hives preparing to swarm in the spring. Place entrance excluder on front of hive with nails (not included) to pin it in place. Use while installing new packages and during the winter as your mouse guard. Actual wt. 0.4 lbs.

- M60065** Entrance Excluder **\$10.95**



M60065

Hive not included

Assembled

8- & 10-FRAME POLLEN AND PROPOLIS TRAPS

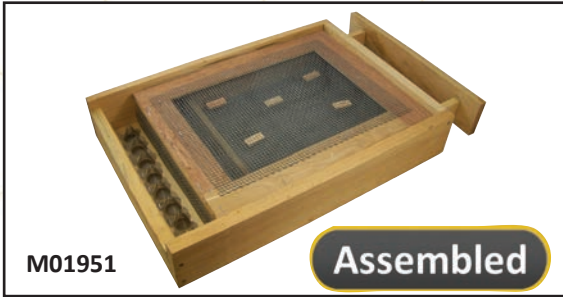

Pollen Trap 8-Frame

This top pollen trap is the finest top mount pollen trap being offered today. When ready to use, just place the trap directly over the top of your hive. A convenient sliding drawer at the rear of the hive makes ease out of removing pollen from the trap. All entrances must be closed for the bees to enter through the top of the pollen trap. Simple to set up, simple to use.

CANNOT BE USED WITH EXCLUDERS

M01951 Actual wt. 5.05 lbs. \$91.95



Pollen Trap 10-Frame

Hive not included



Exterior Pollen Trap — Our most popular trap. Four-sided frame fits between hive bodies. Trap fits on outside of hive. Colony is redirected into pollen trap. Simple and effective. Easy to use.

M00690 Actual wt. 7.42 lbs. \$50.95



Bottom Pollen Trap 10-Frame

Hive not included



Bottom Pollen Trap — A great bottom pollen trap. Long lasting with built-in drone escapes and a convenient side sliding pollen collection drawer. Easy to set up and easy to use. Actual wt. 6.95 lbs.

M00682 1-4 \$99.95
 5-19 \$94.95
 20+ \$93.95

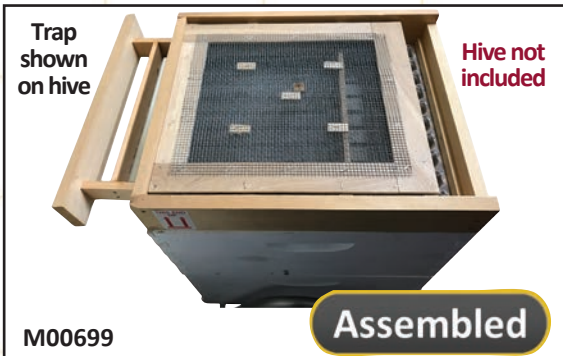

Sundance II Pollen Trap 10-Frame

Sundance II Pollen Trap — We are pleased to offer a new approach to collecting pollen. The Sundance II top pollen trap is the finest top mount pollen trap being offered today. When ready to use, just place the trap directly over the top of your hive. A convenient sliding drawer at the rear of the hive makes it easy to remove pollen from the trap. All entrances must be closed for the bees to enter through the top of the pollen trap. Simple to set up, simple to use. Actual wt. 6.32 lbs.

CANNOT BE USED WITH EXCLUDERS

M00699 \$92.95

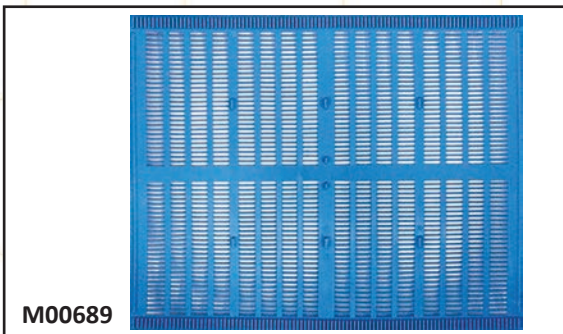

Propolis Trap 10-Frame

Propolis Trap — Earn extra money collecting and selling propolis. Trap installs in place of inner cover. Once finished collecting propolis place trap in garbage bag and into deep freeze. Once frozen propolis will easily come off screen for you to collect and clean.

M00689 1-9, Ship wt. 1 lb. ea. \$10.95
 10-99, Ship wt. 10 lbs./10 \$10.25
 100+, Ship wt. 93 lbs./100 \$9.95

8-FRAME HIVE KITS

Assembled Garden Hive with 9⁵/₈" Brood Boxes

For those wishing to use larger brood chambers we have the 9⁵/₈" depth 8-frame Dadant Garden Hive. Select grade wood is hand picked for these kits and assembled with ultimate care. Comes completely assembled with 8-frame copper garden cover, inner cover, two 9⁵/₈" depth 8-frame brood boxes, 16 grooved top bar frames with plasticell foundation, solid bottom board and wood stand. Actual wt. 66 lbs.

C52901 9⁵/₈" Assembled Garden Hive

\$269.95

May not be available at all branch locations.



Assembled Garden Hive with 6⁵/₈" Supers

We are pleased to offer the Dadant Garden Hive. Select grade wood is hand picked and assembled for your beekeeping adventure. This 8-frame garden hive will look wonderful in your flower garden or backyard. Comes completely assembled with copper garden top cover, inner cover, two 6⁵/₈" supers, assembled frames with plasticell foundation, solid bottom board and wood stand. Actual wt. 64 lbs.

C52801 6⁵/₈" Assembled Garden Hive

\$265.95

May not be available at all branch locations.



C52901

PONDEROSA PINE LASTS LONGER



C52801

8-FRAME BEGINNER'S KITS



PONDEROSA PINE LASTS LONGER



Unassembled 8-Frame Beginner's Kit

- 1 - 8-frame 9 $\frac{5}{8}$ " beehive
- 8 - 9 $\frac{5}{8}$ " grooved top bar frames
- 8 - Sheets plastic based foundation
- 1 - Bottom board
- 1 - Telescoping metal cover
- 1 - Inner cover
- 1 - Reversible entrance reducer
- 1 - Entrance feeder
- 1 - All purpose hive tool
- 1 - Hat Veil Pullover Combo
- 1 - Sting resistant gloves
- 1 - Bee smoker — to calm bees
- 1 - Smoker fuel 1 lb.
- 1 - Book — *First Lessons in Beekeeping*
- 1 - Assembly instructions

8-Frame Beginner Kit This 8-frame hive kit comes with everything you will need to start your first colony of bees except for the bees themselves. This kit comes knocked down for your assembly. As your colony grows you will need to add an additional brood box and honey supers.

M59701 8-Frame Beginner Kit,
Actual wt. 34.32 lbs. **\$243.95**

Unassembled 8-Frame Starter Kit

- 2 - 8-frame 6 $\frac{5}{8}$ " supers
- 16 - 6 $\frac{1}{4}$ " grooved top bar frames
- 16 - Sheets plastic based foundation
- 1 - Bottom board
- 1 - Telescoping metal cover
- 1 - Inner cover
- 1 - Reversible entrance reducer
- 1 - Entrance feeder
- 1 - All purpose hive tool
- 1 - Hat Veil Pullover Combo
- 1 - Sting resistant gloves
- 1 - Bee smoker — to calm bees
- 1 - Smoker fuel 1 lb.
- 1 - Book — *First Lessons in Beekeeping*
- 1 - Assembly instructions

8-Frame Starter Kit For ease of lifting we recommend the starter kit with 6 $\frac{5}{8}$ " depth 8-frame supers. Includes all you will need to get going in beekeeping except for the bees. Additional supers will be needed as your hive grows. Comes knocked down.

M59801 8-frame Starter Kit,
Actual wt. 41.62 lbs. **\$259.95**

-- NO SUBSTITUTIONS OR PARTIAL RETURNS ON KITS --

8-FRAME BEEKEEPING EQUIPMENT



B52601

Not Assembled

8-Frame Complete Hive *without foundation*

- Superbly constructed 9 $\frac{5}{8}$ " Select Grade Ponderosa Pine Hive Body
- Bottom Board with Reversible Reducer for summer and winter bee entrance
- 8 - 9 $\frac{5}{8}$ " Wedged Top Bar Frames
- Wood Entrance Reducer Inner Cover

PONDEROSA PINE LASTS LONGER

Nails included for all components.

Notice: Select wood may not be available in all branch locations.

B52601 Carton of 1, Actual wt. 25.58 lbs. . . \$105.95 ea.

UNASSEMBLED 8-FRAME SUPERS

8-Frame 9 $\frac{5}{8}$ " DEEP SUPERS

Wood Grade (see page 3)	Quantity (Nails Not Included - See page 18)			
	1-10	11-49	50-249	250 - 499
Select	B50231 Actual wt. 7.8 lbs. ea. \$24.95	B50231 Actual wt. 7.8 lbs. ea. CALL	B50231 Actual wt. 7.8 lbs. ea. ea. CALL	B50231 Actual wt. 7.8 lbs. ea. CALL
Commercial	B50271 Actual wt. 7.8 lbs. ea. \$21.95	B50271 Actual wt. 7.8 lbs. ea. \$17.95	B50271 Actual wt. 7.8 lbs. ea. \$16.95	B50271 Actual wt. 7.8 lbs. ea. ea. CALL

For quantities of 500+ Call for price



8-Frame 6 $\frac{5}{8}$ " HONEY SUPERS

Wood Grade (see page 3)	Quantity (Nails Not Included - See page 18)			
	1-10	11-49	50-249	250 - 499
Select	B31501 Actual wt. 5.54 lbs. ea. \$23.95	B31501 Actual wt. 5.54 lbs. ea. CALL	B31501 Actual wt. 5.54 lbs. ea. CALL	B31501 Actual wt. 5.54 lbs. ea. CALL
Commercial	B34000 Actual wt. 5.54 lbs. ea. \$19.95	B34000 Actual wt. 5.54 lbs. ea. \$15.95	B34000 Actual wt. 5.54 lbs. ea. \$14.95	B34000 Actual wt. 5.54 lbs. ea. CALL

For quantities of 500+ Call for price



8-Frame 5 $\frac{1}{16}$ " SHALLOW SUPERS

Wood Grade (see page 3)	Quantity (Nails Not Included - See page 18)			
	1-10	11-49	50-249	250 - 499
Select	B32501 Actual wt. 4.28 lbs. ea. \$23.95	B32501 Actual wt. 4.28 lbs. ea. CALL	B32501 Actual wt. 4.28 lbs. ea. CALL	B32501 Actual wt. 4.28 lbs. ea. CALL
Commercial	B34300 Actual wt. 4.28 lbs. ea. \$19.20	B34300 Actual wt. 4.28 lbs. ea. \$15.20	B34300 Actual wt. 4.28 lbs. ea. \$14.20	B34300 Actual wt. 4.28 lbs. ea. CALL

For quantities of 500+ Call for price



Assembled Hive Body Only

We are offering three sizes of 8-frame boxes, assembled without frames and foundation. Made of NW Ponderosa pine, all wooden supers have tapered cut handholds for easy gripping, uniform interlocking joints to prevent cracks, and interlocking construction for superior strength.

5 $\frac{1}{16}$ " Shallow Super

Assembled
without frames
& foundation



C32501 Select 5 $\frac{1}{16}$ " Shallow Super
Actual wt. 4.14 lbs.. ea.
Carton of 1. \$26.95 ea.
5+ \$24.95 ea.

6 $\frac{5}{8}$ " Honey Super

Assembled
without frames
& foundation



C315018 Select 6 $\frac{5}{8}$ " Honey Super
Actual wt. 5.32 lbs. ea.
Carton of 1. \$27.95 ea.
5+ \$25.95 ea.

9 $\frac{5}{8}$ " Deep Super

Assembled
without frames
& foundation



C50231 Select 9 $\frac{5}{8}$ " Deep Super
Actual wt. 7.66 lbs. ea.
Carton of 1. \$29.95 ea.
5+ \$27.95 ea.

8-FRAME BOTTOM BOARDS AND TOP COVERS



Cypress Bottom Board with West Trap, Landing Board and IPM Board

This ultimate bottom board does it all. Made of Cypress this all in one bottom board will trap and kill SHB, allows you to check for mites with the IPM board, and gives your bees a landing board to land on when coming back from foraging. Fully Assembled. 8-frame bottom board is a modified 10-frame bottom board. It will have larger outer dimensions than your 8-frame equipment.

M60045 8-Frame Cypress Bottom Board, Actual wt. 4.25 lbs. \$43.95

M60040 10-Frame Cypress Bottom Board, Actual wt. 5.5 lbs. \$43.95

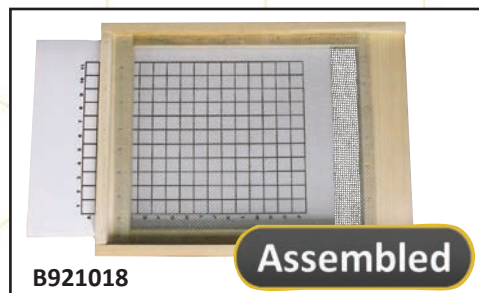

B921018

Assembled

Screen IPM Board

This integrated pest management bottom board comes complete with varroa monitoring screen. Access the screen from front of the hive below the bottom board. Leave the screen out when not monitoring varroa levels to provide extra ventilation and allow mites to fall through to the ground.

B92101 10-Frame, Actual wt. 3.08 lbs. \$29.95

5+ \$27.05

B921018 8-Frame, Actual wt. 2.76 lbs. \$29.95

5+ \$27.65



Replacement Boards

B92101-01 10-Frame, Actual wt. 0.34 lbs. \$7.95

5+ \$7.75

B921018-01 8-Frame, Actual wt. 0.28 lbs. \$7.95

5+ \$7.75

Assembled 8-Frame Solid Bottom Board

Our 8-frame assembled solid bottom board will give you years of service. Made of the finest North Western Ponderosa pine. One wood entrance reducer (B93201) is included. Actual wt. 4.84 lbs.

C91301 8-Frame Solid Bottom Board \$28.95



C91301

Assembled

Assembled 8-Frame Telescoping Cover

Fully assembled 8-frame telescoping cover with heavy galvanized metal top. This entire cover "telescopes" over the inner cover and a portion of the top super. Inner cover sold separately. Actual wt. 5.98 lbs.

C11501 8-Frame Telescoping Cover \$37.95

5+ \$35.95



C11501

Assembled

Garden Copper Top Cover

We are pleased to offer the Dadant 8-frame Garden Copper Top. It is made of the finest materials available. *Please note that we will not accept returns of the copper tops due to scratches or spots caused by touching the copper. May not be available at all branch locations.* Actual wt. 13.55 lbs.

C12601 Garden Copper Top Cover \$89.95

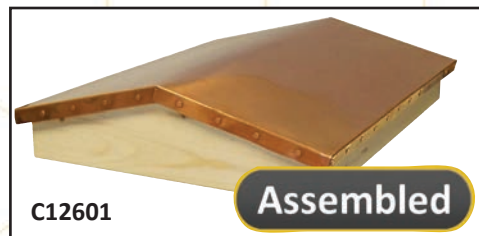

C12601

Assembled

Clear Dome Cover 8-Frame

Clear Dome Cover for your beehive. This cover allows you to see the activity in the hive without having to open the hive. Perfect for visitors to see the active honey bees moving on the frames or feeding on a feeder in your hive. The people who are curious about the beehive but are nervous about the honey bees can see the action without disturbing the honey bees. Actual wt. 0.45 lbs.

M016108 8-Frame Clear Dome Cover \$19.95



M016108

8-FRAME INNER COVERS

Ultimate Insulated Inner Hive Cover

The Ultimate Inner Hive Cover reduces energy demand for healthier and happier bees that produce more honey and over winter more successfully. Multiple wintering entrance options to fit any apiary need. Part of a complete modular/component system of beekeeping products. Actual wt. 3.15 lbs.

M01606 \$32.50



M01606

Assembled 8-Frame Inner Cover

Masonite inner cover is strong and durable. Use with bee escape to clear bees from honey supers. Actual wt. 1.7 lbs.

B15601 8-Frame Inner Cover \$19.95



B15601

Assembled

Assembled 8-Frame Ventilated Inner Cover

Use our fully assembled 8-frame ventilated cover to help with ventilation and increase honey production. Actual wt. 1.14 lbs.

B17501 8-Frame Ventilated Inner Cover \$19.95



B17501

Assembled

PONDEROSA PINE LASTS LONGER

Plywood Inner Cover with Feeder Hole

These inner covers work great to feed your colonies while keeping pesky critters including robbing bees away. Place an empty hive body on top to act as a shell and then your telescoping cover. Use a standard Boardman feeder cap in hole with a quart or 5 lb. round container of syrup. Actual wt. 1.7 lbs.

M60050 8-Frame Plywood Inner Cover \$20.95

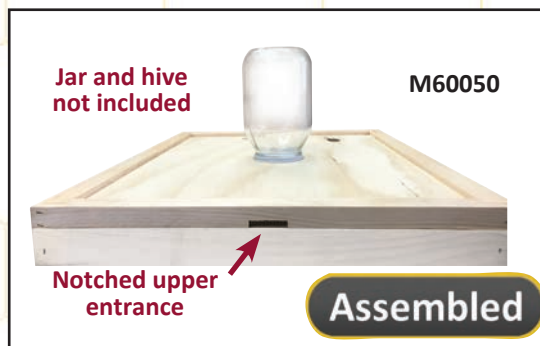

Jar and hive not included

M60050

Notched upper entrance

Assembled

Super Shim

The super shim is to be used only when your honey supers have been completely drawn out. Place shim above your queen excluder and below your honey super to give the bees an upper entrance/exit from the honey supers.

Note: Bees will burr comb the space from bottom of shim to bottom of super should you leave it on too long. Actual wt. 0.6 lbs.

B100148 8-Frame Super Shim \$7.25
5+ \$6.75

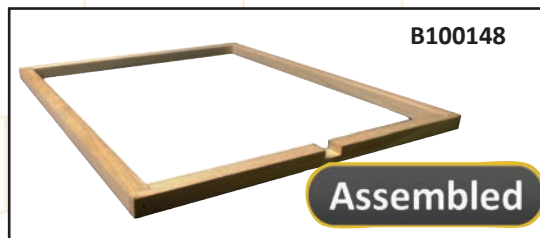

B100148

Assembled

Slatted Rack

You asked for it and here it is. The slatted rack sits in between your bottom board and brood box, providing ventilation and extra space for the bees. The additional room provided when using the slatted rack is thought to help reduce swarming. Frames line up with the slats so varroa will fall through the screens in your bottom boards. Actual wt. 2.8 lbs.

B914018 8-Frame Slatted Rack \$28.95
5+ \$26.95



B914018

Assembled

8-FRAME EXCLUDERS AND STANDS

Metal Bound Excluder

The metal bound excluder has the same precisely spaced welded wires as the wood bound excluder. This wire grid is edged (bound) with metal on all edges.

M00893 8-Frame Metal Bound Excluder, Actual wt. 2.05 lbs. . . . \$11.35 ea.



M00893

Improved Plastic Excluder

This excluder is all plastic with properly sized openings for the worker bees to travel through. Flexible and durable. Easy to clean, corrosion proof.

Actual wt. 0.55 lbs.

M008658 8-Frame Plastic Excluder

1-9	\$6.65
10-49	\$6.05
50-499	\$5.50
500+	\$4.60

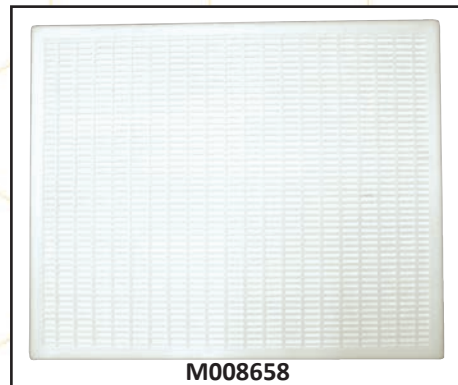

M008658

Dadant Stainless Hive Stand

Dadant-made Stainless Steel Hive Stands sleek design is perfect for all types of apiaries. From a single hive operation to a 20 colony out yard, these stands are made to last. Ships knocked down. Easy to assemble.

M00698 8-Frame Stainless Steel Hive Stand, Actual wt. 7.5 lbs. . . . \$89.00

Ultimate Hive Stand Deluxe Model

The Ultimate Hive Stand Deluxe Model is the only hive stand you will ever need. It has a classic design that is fully functional and looks great in any apiary or garden. It has swing out frame holders to make working the hive easier and when not in use will fold up out of the way. The stand raises the hive 12 inches off the ground for easier access and better ventilation. It works with any bottom board and no wooden hive stand is needed. It is fast and easy to assemble, usually taking less than 2 minutes with a screwdriver. It is made from recycled materials.

M01694 8-Frame Ultimate Hive Stand, Actual wt. 8.88 lbs. . . . \$94.95



M00698

Stainless steel

AntCant

The AntCant™, ant barrier coating (patent pending) was scientifically developed to be a non-toxic, low maintenance deterrent from ant infestation. The coating works by preventing the ants from attaching to an inclined coated surface. Since they can't get a grip, they fall off and do not make it to the attractant. Includes 3.5 oz. bottle and a roll of 2" aluminum tape.



M001440 AntCant
Actual wt. 0.5 lbs. . . . \$29.95

Assembled 8-Frame Cedar Hive Stand

Our 8-frame Cedar hive stand will keep your bottom boards up and off the ground and give you years of service. Both solid and screened bottom boards will work with these. Actual wt. 2.18 lbs.

C02305

8-Frame Cedar Hive Stand
\$22.55



M01694



C02305

BEE MAX HIVE

A BeeMax Hive lets your bees spend more time raising brood and collecting nectar instead of heating or cooling the hive.

BeeMax Deluxe Hive Stand

M01696 10-Frame for BeeMax Hive
Actual wt. 9.18 lbs. \$106.95



The Best Bee Insulation Your Money Can Buy!

A complete Assembled Unit Contains:

- 1 - Hive Cover
- 1 - BeeMax Inner Cover
- 1 - Standard Hive Body
- 10 - Standard Wood Assembled Frames with Plasticell Foundation
- 1 - Ventilated Bottom Board

~ Features ~

- Durable
- Proven Design and Testing
- Expert North American Construction
- Well ventilated
- Cooler in Summer
- Warmer in Winter

or you can purchase the components separately!



We recommend painting your hive and super on the outside only and with latex paint.

- M58851** Complete Assembled Unit, Actual wt. 20.08 lbs. ea. \$129.95
- M58901** Bottom, Actual wt. 1.9 lbs. ea.
 - 1-4 \$27.95
 - 5-49 \$23.95
 - 50+ \$21.95
- M58801** Hive Body (Empty), Actual wt. 3.24 lbs. ea.
 - 1-4 \$32.95
 - 5-49 \$29.95
 - 50+ \$25.95
- M59101** 6 7/8 Super (Empty), Actual wt. 2.2 lbs. ea.
 - 1-4 \$26.95
 - 5-49 \$24.95
 - 50+ \$22.95

- M59001** BeeMax Hive Cover, Actual wt. 1.86 lbs. ea.
 - 1-4 \$26.75
 - 5-49 \$25.95
 - 50+ \$24.95
- B16001** BeeMax Inner Cover, Actual wt. 2.4 lbs. ea.
 - 1-4 \$18.95
 - 5-24 \$17.95
 - 25+ \$15.95
- M59501** Entrance Feeder Complete, Actual wt. 0.35 lbs. ea. (use with BeeMax Hive only)
 - 1-49 \$8.95
 - 50+ \$8.40
- M01696** 10-frame Beemax Deluxe Hive Stand, Actual wt. 9.18 lbs. ea. \$106.95

BeeMax Hive Kit

BeeMax Hive Kit contains everything necessary for the beginner to start that first colony of bees, except the bees themselves.

Kit includes:

- 1 - Insulated BeeMax Hive
- 1 - Ventilated, Screened Bottom Board
- 10 - Standard Wood Assembled Frames with Plasticell Foundation
- 1 - Alexander Veil
- 1 - Telescoping BeeMax Hive Cover
- 1 - BeeMax Inner Cover
- 1 - BeeMax Entrance Feeder
- 1 - All Purpose Hive Tool
- 1 - Bee Smoker to calm bees
- 1 - Smoker Fuel 1 lb.
- 1 - Sting Resistant Gloves
- 1 - Book *First Lessons in Beekeeping*
- 1 - Assembly Instructions

M58800 BeeMax Hive Kit, Actual wt. 55 lbs. \$249.95



Prolonged contact with Paradichlorobenzene (moth crystals) may damage BeeMax products
— NO SUBSTITUTIONS OR PARTIAL RETURNS ON KITS —

WORLD'S BEST BEE SMOKERS

COPIED BY MANY - BUT MATCHED BY NONE

Premium Smokers • Excellent Smoke Output • Superior Bellows Design



M00926

M00926 4x7 Stainless Steel Smoker,
Actual wt. 2.3 lbs. ea. \$48.95



M00927 ****Best Value****

M00927 4x7 Stainless Steel Smoker with Shield,
Actual wt. 2.45 lbs. \$55.95

“The Design That Works”

Dadant bee smokers are still *Made in the U.S.A. by us.*
Don't settle for less than the best, in the original
fashion of the Bingham smoker.

These smokers are of the original Bingham design that is of time proven quality. Dadant has been manufacturing these smokers since they acquired the A.G. Woodman company in the 1970's, and are proud to produce the smoker that everyone tries to duplicate.



4 Models

Smoker Bellows Replacements



M008041



Reverse side

- Flexible, tough Naughehyde fabric
- New face boards hold staples firmly
- Aluminum easy-grip edging
- Air valve for best operation

M008041 4-Bolt Replacement Bellows,
Actual wt. 0.9 lbs. ea. \$19.95



M00928

M00928 4x10 Stainless Steel Smoker with Shield,
Actual wt. 2.6 lbs. ea. \$57.95



M009281

M009281 4x10 Stainless Steel Smoker with Shield
(Finger Heat Guard),
Actual wt. 2.85 lbs. ea. \$59.95



M01944

Domed Smoker

Don't be fooled by the other guys' high priced imported smokers. If you are looking for a decent smoker at a discount price, this is the smoker for you.

M01944 4 x 7 Domed Smoker,
Actual wt. 2.45 lbs. ea. \$36.95



M019441

**Replacement Bellows
for M01944 Domed Smoker**
Imported domed smoker bellows

M019441 Domed Smoker Bellows,
Actual wt. 0.75 lbs. ea. . . . \$17.95



M02210

Jute Burlap Roll - Smoker Fuel

The Jute Burlap Roll makes a great smoker fuel. Easy to ignite and produces a light cool smoke. Unrolls for easy use and storage.

M02210 Actual wt. 4.2 lbs. \$27.95



M00808

M008085

— Fast Lighting —
— Easy Use —

Wood Pellet Smoker Fuel

Wood Smoker Pellets

- * Long lasting smoke *
- * Makes your trip to the bee yard better *
- * Your smoker is always ready...
when Smoker Pellets are used *

Recommended for Commercial Use

M008085 5 lb. bag, Actual wt. 5.05 lbs. \$8.25

M00808 40 lb. bag, Actual wt. 40.7 lbs. \$16.95



M00810

Smoker Fuel

All cotton fibers make this the smoker fuel of choice. Can be easily lit with a match or lighter for a long continuous burn. Much easier to light than the plugs of the past. A simple solution to the never ending search for smoker fuel. Actual wt. 1 lb. ea.

M00810 1 lb. package \$7.95

5-39 lbs. \$7.45/lb

ESSENTIAL HIVE TOOLS

for working with Honey Bees



10" Painted M00757 9.5" Economy M007571 9.5" Yellow M00760 7.5" Small Yellow M00761 J Hook M00856 Italian M01948 Turbo M01953 6" Hive Tool M01978

M00757	Painted Hive Tool, Actual wt. 0.35 lbs. ea.	\$13.50
M007571	Economy Hive Tool, Actual wt. 0.35 lbs. ea.		
	1-9		\$8.95
	10+.....		\$8.75
M00760	9.5" Yellow Hive Tool, Actual wt. 0.3 lbs. ea.	\$16.50
M00761	7.5" Small Yellow Hive Tool, Actual wt. 0.2 lbs. ea.	\$14.50
M00856	J Hook Hive Tool, Actual wt. 0.25 lbs. ea.	\$12.95
M01948	Italian Hive Tool (Length - 12.5"), Actual wt. 0.25 lbs. ea.	\$8.95
M01953	Turbo Hive Tool, Actual wt. 0.4 lbs. ea.	\$20.95
M01978	6" Hive Tool, Actual wt. 0.15 lbs. ea.	\$8.75

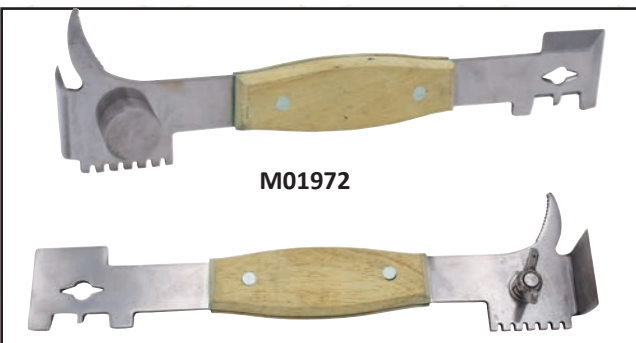

M01972

Multi-Purpose Tool

- Made of hard stainless steel material and wooden handle.
- Hive tool functions include, J-Hook framer puller, scraper, frame cleaner, nail puller, queen bee excluder cleaner, pry bar, detachable hammer & more. Color may vary.

M01972 Multi-Purpose Tool
Actual wt. 0.63 lbs. ea. **\$18.95**

HAND TOOLS AND FRAME SPACING TOOLS

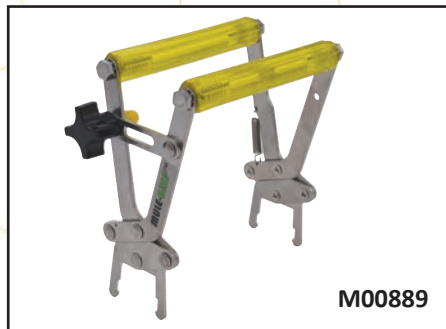

M00889

Mule Frame Grip

Little Mule frame grips are the top of the line. Holding both wooden or plastic frames these frame grips have a locking 1" arm that helps reduce hand strain. Get a grip on your frame with this durable stainless steel frame gripping device. Made in USA. Actual wt. 0.84 lbs. ea.

M00889 \$29.95



M00754

Frame Grip

Grips top bar of frame for loosening and removing frames from supers. Single spring allows one hand operation. Actual wt. 0.6 lbs. ea.

M00754 \$26.50



M00748

Round Handled Frame Grip

This frame grip is as tough as all the others, but at a portion of the cost. Rounded handles make for an easy grip. Actual wt. 0.6 lbs. ea.

M00748 \$15.95

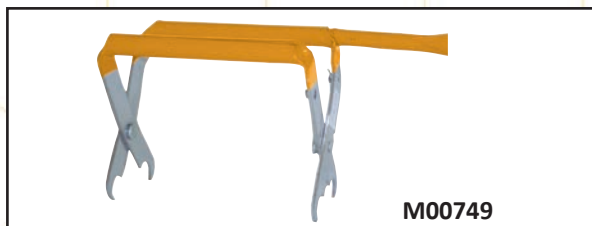

M00749

Frame Grip

This handy tool, imported from Portugal, features a combination frame manipulation tool and frame grip all in one. Loosen the frame with the tool end then grip.

M00749 Actual wt. 0.5 lbs. ea. \$17.95



M00751

Soft, Flexible Bristles
—Won't Injure Bees

Bee Brush

The bee brush has long, soft, flexible yellow bristles that are gentle enough for brushing bees off queen cells yet firm enough to remove bees from frames, supers, or clothes. Will not crush or injure bees. A sturdy all purpose wooden handle brush. Can be washed. Actual wt. 0.25 lbs.

Color may vary.

M00751 1-5 \$8.95
6+ \$7.95

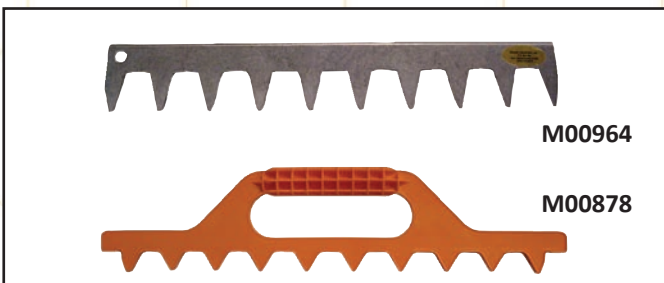

M00964

M00878

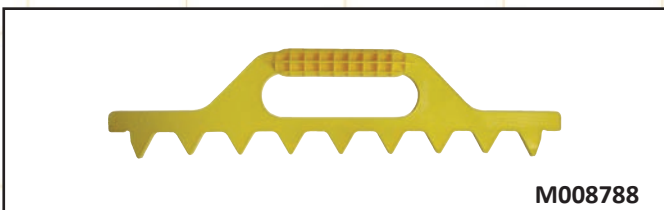

M008788

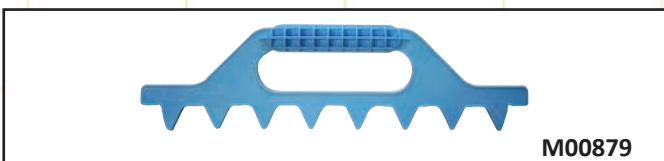

M00879

9-Frame Spacing Tools

These tools will easily space 9-frames in a 10-frame honey super. The bees will extend the comb beyond the edge of the frame making uncapping easier and quicker. Available in stainless steel or plastic.

M00964 Stainless Steel 9-Frame Spacing Tool
Actual wt. 0.35 lbs. ea. \$22.95

M00878 Plastic 9-Frame Spacing Tool
Actual wt. 0.2 lbs. ea. \$15.95

Plastic 8-Frame Spacing Tool

This tool will easily space 8-frames in a 10-frame honey super. The bees will extend the comb beyond the edge of the frame making uncapping easier and quicker.

M008788 Plastic 8-Frame Spacing Tool
Actual wt. 0.2 lbs. ea. \$15.95

Plastic 7-Frame Spacing Tool

This tool is used to space 7-frames in an 8-frame box.

M00879 Plastic 7-Frame Spacing Tool
Actual wt. 0.2 lbs. ea. \$15.95

BEEHIVE MOVING ACCESSORIES



M01607

Ultimate Universal IPM Robber Screen

Brought to you by Bee Smart this robbing screen works well on most 8- and 10-frame bottom boards. Cutting the screen down to fit correctly on some styles of bottom boards is needed. EZ installation with stainless push in pins. Great ventilation, UV protected. Actual wt. 0.25 lbs.

M01607 \$12.95



B93401

Moving Robber Screen

A two-in-one tool. These screens can be left on all season long. Close the screen off to help cut down on weaker colonies being robbed and use the top exit, or close them off completely to move hives from one location to the next. Available in 8-frame, Actual wt. 0.7 lbs. and 10-frame. Actual wt. 0.6 lbs. ea.

B93401 10-Frame \$23.95
B934018 8-Frame \$22.95



M00318

Hive Carrier

Convenient tool to transport heavy hives or supers. Lets two people move a hive from the truck to the yard and move supers from the hive to the truck. Galvanized steel frame for durability. Designed for easy operation. **Hive sold separately.** Actual wt. 6.25 lbs. ea.

M00318 \$93.95

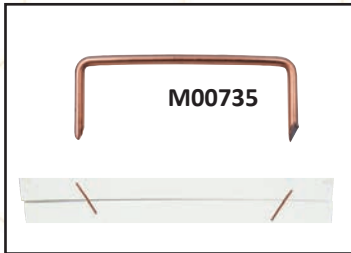

M00735

Staples penetrate 3/4". Points 2" apart. Quick, easy way to fasten bottom board to hive body. Approx. 125 per lb.

Call for Quantity Pricing

M00735 per lb., Actual wt. 1.1 lbs. \$13.95
M00736 10 lbs., Actual wt. 10.3 lbs. \$83.95
M00737 50 lb. keg., Actual wt. 50.9 lbs. \$289.95

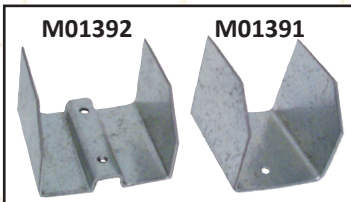

M01392

M01391

Pallet Clips — 2 Styles

Secure your hives to pallets with these clips. We offer both the W and U style.

M01392 Pallet Clip - style W
Actual wt. 0.2 lbs. \$1.95
M01391 Pallet Clip - style U
Actual wt. 0.18 lbs..... \$1.95



Close-up of closure

V02000

Hive Net

For use when moving hives from yard to yard or to keep bees inside the colony due to herbicide spraying. Actual wt. 1 lb.

V02000 \$33.95



M00325

Single Super/Hive Carrier

Convenient tool to transport heavy hives or supers. Lets one person move a super from the truck to the yard. Galvanized steel frame for durability. Designed for easy operation. Actual wt. 4 lbs. ea. **Hive sold separately.**

M00325 \$72.95



M01395

M01396

Ratchet Straps

Unique shock absorbing tie down that incorporates three of the most versatile tie down principles into one superior system. Maintains constant tension and acts like shock absorbers keeping your load secure. Dependable, Durable, and Rust Resistant. Backed by manufacturer 2 Year warranty, this is the best tie down strapping on the market for your Bee Hives, Bobcats, or Hummer Bees.

M01395 10' Black Cam Strap, Actual wt. 1.45 lbs. \$22.95
M01396 18' Ratchet Strap, Actual wt. 4.5 lbs. \$37.95

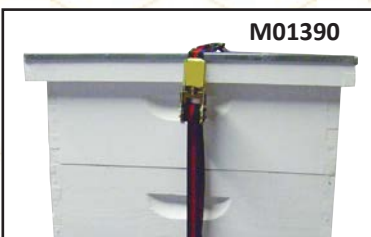

M01390

Black/Red Tie Down Strap

No nails, staples or ropes ever again! Easy-to-use tie down straps with tensioning buckle secures your beehive every time. No slipping — No worries! Actual wt. 0.7 lbs. ea.

M01390 \$9.85

ENTRANCE REDUCERS, FRAME SPACERS, HOLDERS AND FIXERS

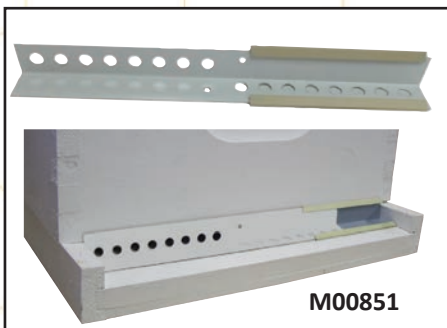

Universal Entrance Reducer

- Eight 3/8" entrance holes
- Made with durable 24 gauge baked-on metal
- Screw holes provided if you want to fasten to hive
- Mouse-proof

M00851 Actual wt. 0.2 lbs. ea.

1-9	\$4.95
10-49	\$4.55
50-99	\$4.40
100-499	CALL

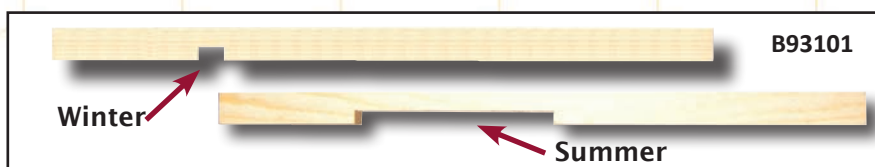

Wood Entrance Reducer

The standard of the industry for 100 years. Two entrance/exit sizes. Small for winter and large for summer. *Hint:* Reduce the entrance size until your valuable package bees are established. For use with standard pine bottom boards.

B93101 10-Frame - Wood Entrance Reducer, Actual wt. 0.1 lbs. ea.	\$2.60
B93201 8-Frame - Wood Entrance Reducer, Actual wt. 0.1 lbs.	\$2.60

Metal Entrance Reducer *Original Galvanized*

Quickly and easily installed on 10-frame hive. Fasten metal clips at both sides, slip reducer behind clips. Opening is 6" wide. Provides winter entrance. Keeps mice out. Screws included. Priced per set. Actual wt. 0.15 lbs. ea.



M00855 1-11 sets each	\$3.85
12-99 sets each	\$3.75
100+ sets each	\$3.60



Frame Fixer

Don't throw those valuable frame-comb combinations away because of a broken top bar end. Repair frame top bar ends with these 20 ga. galvanized frame fixers. Nails included. Actual wt. 0.05 lbs. ea.

M00718 1-99	\$.75
100-999	\$.60
1000+	\$.50



Economy Frame Holder

This economy frame holder will do the trick at the right price. Place up to 3 frames at a time on our economy frame holder. Actual wt. 0.75 lbs.

M01949 Economy Frame Holder	\$17.95
------------------------------------	-------	----------------



Frame Holder

Why bend over and set frames on the grass, or try to balance them against the hive? With the Frame Holder, now your brood or honey filled frames are at your fingertips. Frame Holder, the most efficient and convenient way to hold valuable comb filled frames removed from the colony during inspection. Actual wt. 0.9 lbs. ea.

M00319 Frame Holder	\$25.95
----------------------------	-------	----------------



Metal Frame Spacer

Metal Frame Spacers are metal devices which have cutouts to receive the frames and space them evenly. They fit over the frame support area of hive bodies and supers of the 10-frame size. They are great time savers. They allow even spaces for the bees to fully draw combs and they protect frame rests. Actual wt. 0.1 lbs. ea.

M00874 9-Frame Spacers	M00875 8-Frame Spacers
1-99, ea. \$.95	1-99, ea. \$.95
100-499, ea. \$.75	100-499, ea. \$.75
500+, ea. CALL	500+, ea. CALL

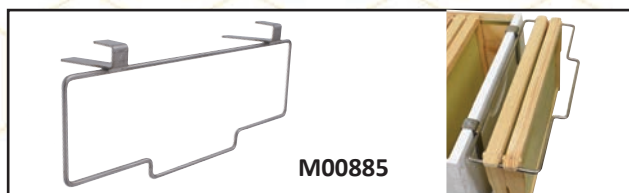

Mule Grip Frame Holder

The little mule frame holder will accommodate 3 frames. Its all stainless design and tight fit makes sure your frames do not fall to the ground. Made in USA. Actual wt. 1.3 lbs. ea.

M00885 Mule Grip Frame Holder	\$31.95
--------------------------------------	-------	----------------

COMB HONEY PRODUCTION



M00006
M001242DVD

Honey In The Comb Learn How To Produce Comb Honey

By Eugene E. Killion. Twelve comprehensive chapters cover every aspect of comb honey production in both round and square sections. 165 brand new photographs and equipment drawings, completely cross-indexed. 148 pages, softbound in honey gold. Also, don't miss the DVD by Gene Killion complementing his book of the same title. An excellent guide and aid for the novice and experienced beekeeper alike.

- M00006** Honey in the Comb Book, Actual wt. 0.6 lbs. ea. **\$10.80**
M001242DVD Honey in the Comb DVD, Actual wt. 0.1 lbs. ea. **\$20.55**
M00006SET Honey in the Comb Book & DVD Set, Actual wt. 0.66 lbs. ea. . . . **\$30.40**



M00778

Wax Tube Fastener

Wax Tube Fastener is ideal for securing foundation into grooved top bar (cut comb and chunk honey) frames. Metal cylinder is filled by lowering into container of hot, liquid beeswax. When cylinder is filled, wax is retained in cylinder by placing finger over air hole. With foundation in place, the wax tube fastener is run along the top bar groove. By removing finger from the air hole, a small amount of wax flows out to cement the foundation to the top bar.

- M00778** Wax Tube Fastener, Actual wt. 0.95 lbs. ea. **\$17.95**



M00753

Frame Cleaner

A handy tool to clean top or bottom groove of any style frame. Quickly removes wax and propolis from grooves. Especially useful for comb honey production.

- M00753** Frame Cleaner. Actual wt. 0.05 lbs. ea. **\$8.95**



M00336

Serrated Comb Honey Knife

The best comb cutting knife we have found. This extremely sharp and serrated knife makes slicing through comb a breeze. Total knife length 8.5" (blade length 4")

- M00336** Serrated Comb Honey Knife,
Actual wt. 0.1 lbs. ea. **\$16.95**



M00770

Section Scraping Knife

This knife is specially designed and constructed for cleaning wax and propolis from finished sections. The notch in the top is ideal for edges — it prevents cutting into the honey.

- M00770** Section Knife,
Actual wt. 0.5 lbs. ea. **\$17.95**



Cut 4 7/8" x 4 7/8"
M00937
 MADE IN THE USA
 Cut 3 3/4" x 3 3/4"
M00938

Comb Cutters

Comb Cutter — Cut 4 7/8" x 4 7/8" sections of comb honey to fit standard cut comb boxes, M00250, (see page 102).

Small Comb Cutter — Cut 3 3/4" x 3 3/4" sections of comb honey to fit, M00251, Economy Cut Comb Boxes (see page 102).

All food grade stainless steel. Sharpened cutting blade. Sturdy stainless steel handle. Made in the USA. Actual wt. 0.36 lbs. ea.

- M00937** Stainless Steel Comb Cutter 4 7/8" x 4 7/8" **\$15.95**
M00938 Small Stainless Steel Comb Cutter 3 3/4" x 3 3/4" **\$15.95**



NEW!

Comb Honey Cutter

This is a perfect tool for professional and backyard beekeepers who produce cut combs. With this tool, you no longer have to struggle to cut through cut combs using old-style cold cutters and sticky surfaces. The heated cutting blade makes cutting cut combs a breeze. It cuts precisely the exact size of the cut comb every time. It has a separate temperature controller that allows users to increase or decrease the temperature based on their experience in cutting combs. 4 X 4-inch cutting blade.

- M00344** Comb Honey Cutter **\$215.00**

ROUND SECTION COMB HONEY



Component Parts for Round Section Comb Honey

- M01010** Half frames, carton of 36, (makes 72 round sections)
Actual wt. 11.06 lbs. **\$110.95**
- M01013** 200 Section Rings, (2 per section required)
Actual wt. 4.2 lbs. **\$74.95**
- M01014** 400 Section Rings, (2 per section required)
Actual wt. 7.4 lbs. **\$123.95**
- M01015** 200 Clear Covers, (2 per section required)
Actual wt. 7.4 lbs. **\$123.95**
- M01016** 400 Clear Covers, (2 per section required)
Actual wt. 14.96 lbs. **\$229.95**
- M01022** 200 Opaque Covers, (2 per section required)
Actual wt. 7.74 lbs. **\$134.95**
- M01017** 400 Opaque Covers, (2 per section required)
Actual wt. 14.96 lbs. **\$249.95**
- M00953** 100 Round Section Labels
Actual wt. 0.5 lbs. **\$25.95**

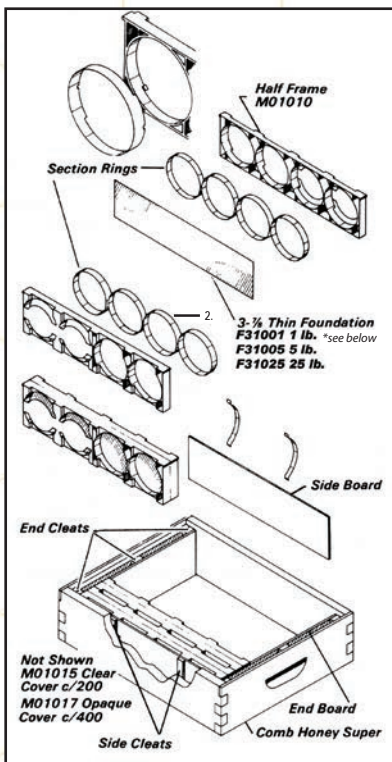

M01024
10-Frame

Complete Round Section Super Ready to Use Except for Installing Foundation

Round Section Super is shipped assembled. Purchase foundation below, (item number **F31001**). Insert it between section half frames, and place super on the hive.

Actual wt. 11.18 lbs. (Covers sold separately — See left hand column — Clear or opaque.)

10-frame holds 8 combs
8-frame holds 7 combs

- M01024** 10-frame ea. **\$159.95**
- M010248** 8-frame ea. **\$159.95**

Each portion of the foundation becomes a part of the comb honey for sale. We use the utmost care in selecting only the very finest of virgin capping wax for the manufacturing of our thin surplus foundation. The raw wax is then washed, cleaned and filtered so only pure 100% beeswax is present in the finished sheet of foundation. Strong sidewalls on each cell help your bees to finish beautiful sections of sparkling white comb honey.

FOR CUT COMB & CHUNK HONEY PRODUCTION

We also recommend 4 $\frac{3}{4}$ " Thin Surplus and 4 $\frac{3}{4}$ " Cut Comb foundation.
All of these products are listed on page 15.

5 $\frac{11}{16}$ " Comb Honey Supers — empty

- B32201** Carton of 1, Actual wt. 5.2 lbs. **\$24.95**
- B32205** Carton of 5, Actual wt. 25.34 lbs. **\$106.95**
- B34400*** Commercial, Carton of 1, 11-49. **\$20.95**
Actual wt. 5.12 lbs. (for larger quantities see page 15)

* Nails not included

5 $\frac{5}{8}$ " Frames

- B77110** 10 Frames per Carton, Actual wt. 4.48 lbs. **\$19.25**
- B77150** 50 Frames per Carton, Actual wt. 21.62 lbs. **\$80.95**
- B85004*** 100 Bulk Frames, Commercial, Actual wt. 38.78 lbs./100 . **\$141.95**

* Nails not included

4 $\frac{3}{4}$ " Cut Comb Foundation

- F32201** 1 lb. of Foundation, Actual wt. 1.3 lbs. **\$24.95**
- F32205** 5 lbs. of Foundation, Actual wt. 5.85 lbs. **\$91.95**
- F32200** 25 lbs. of Foundation, Actual wt. 26 lbs. **\$318.95**

Approximately 18 sheets per pound

100% Beeswax "Thin Surplus" Foundations for Round Comb Honey

Fits Round Section 3 $\frac{7}{8}$ " x 16 $\frac{1}{2}$ "

- F31001** Thin Surplus Foundation, 1 lb. (28 Sheets)
Actual wt. 1.45 lbs. **\$15.95**

- F31005** Thin Surplus Foundation, 5 lbs. (140 Sheets)
Actual wt. 5.9 lbs. **\$71.95**

- F31000** Thin Surplus Foundation, 25 lbs. (700 Sheets)
Actual wt. 26 lbs. **\$259.95**

*Sheets per carton are approximate and may vary in the manufacturing process.

FEED CHART

FEED ADDITIVES & SUPPLEMENTS	METHOD OF APPLICATION	TIME OF YEAR TO APPLY
AP23 & Brood Builder	These pollen subs may be fed either dry or in patty form. If feeding patties and running double brood boxes, place patties between boxes. If running singles feed on top of frames.	Feed in spring to boost colonies populations and in the fall after miticide treatments. May also be fed any time a pollen dearth occurs.
Honey - B - Healthy	Mix 1-2 teaspoons per quart when fed in sugar syrup. Use up to four teaspoons when used as a spray with 1:1 syrup in place of a smoker to calm bees.	Feed during late winter, early spring, fall or dearths of nectar and may also be used to build up nucs, weak colonies and swarms.
HBH Super Plus	Mix 1 tsp. per quart of various sugar water mixes which can be increased to 3 tsp per quart. For patties test effect of 1 tsp. per lb and adjust as needed.	Best in Spring and Fall but can be used any time of year. Feed with Honey Supers removed.
HBH Vitamin B	Add ½ tsp. to each quart or liter of sugar water when feeding. If used in protein patties, add ½ tsp. per 3 lbs dry	Best in Spring and Fall but can be used any time of year. Feed with Honey Supers removed.
Complete	Feed Complete anytime you are feeding sugar syrup. Can be fed in syrup, by drench method and in nutritional supplement protein patties.	Apply Complete whenever feeding is needed.
Nozevit Plus	15-20 drops per colony mixed in ¼ quart sugar syrup or sprayed on frames. May be fed in pollen patties 20 drops per 1 pound.	Use as a feed supplement two times in the spring and fall at 10 day intervals
Optima	It is advised to mix 1 - 2 teaspoons of Optima per gallon of syrup when fed through preferred hive feeder. A 100 ml bottle will make 20 gallons of syrup. When feeding by drench method it is advised to mix 4 teaspoons per quart of syrup and drench at rate of ¼ quart or 10 - 12 ounces solution per colony 4 times at 4 days apart. When feeding in pollen patties ½ teaspoon of optima per lb of patty is recommended.	Whenever feeding is needed or bees are overstressed.
Sugar Syrup	For spring feeding mix 1 part sugar to 1 part water to stimulate foraging. For fall feeding mix 2 part sugar to 1 part water if not enough honey has been stored for winter.	Apply when needed.

Buy 1/2 or full truckloads Call 1-888-922-1293. Minimum 72 Business Hour Notice Required

Liquid feeds available for pick-up at Chico, Fresno, High Springs, Paris, Chatham, Frankfort, and Hamilton or for delivery to your location throughout the U.S.A.

Chatham, VA	1-800-220-8325
Frankfort, KY	1-888-932-3268
Hamilton, IL	1-888-922-1293
Chico, CA	1-877-332-3268
Fresno, CA	1-877-432-3268
High Springs, FL	1-877-832-3268
Paris, TX	1-877-632-3268

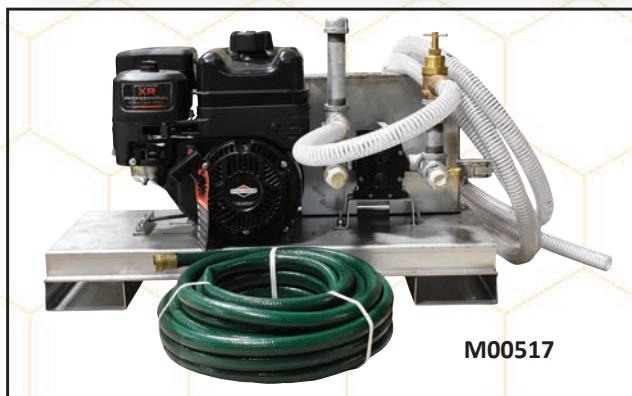

Don't Carry It! Pump It with Dadant's Fructose Pump

Stainless Steel Fructose Pump

Make Feeding Fructose Easy — Pump Directly From Storage Into Feeders

- Pump 1 gallon 70° fructose in 15 seconds
- 5.5 hp 4 cycle B & S OHV gasoline engine
- Ball bearing output shaft
- 1" gear pump with pressure bypass system
- 14' crushproof suction hose
- 50' discharge hose and discharge nozzle

M00517 Fructose Pump, Actual wt. 150 lbs. ea. **\$2,295.00**
Ships Freight Only

TOP FEEDERS

Wooden Hive Top Feeder with Plastic Trough

Feeding your bees has never been easier. Our newly designed 8- and 10-frame top feeders are the ticket to get your bees up to weight. The 8-frame feeder will hold 2 gallons of syrup and our 10-frame model will accommodate 2.5 gallons of syrup. Sloped bottom ends of the feeder will feed syrup to the trough area when placed on level hives. Easy to read fill lines at the one and two gallon mark help you measure the right amount of syrup needed.

- M01436** 10-Frame, Actual wt. 5 lbs. ea. **\$39.95**
- M01435** 8-Frame, Actual wt. 5 lbs. ea. **\$39.95**

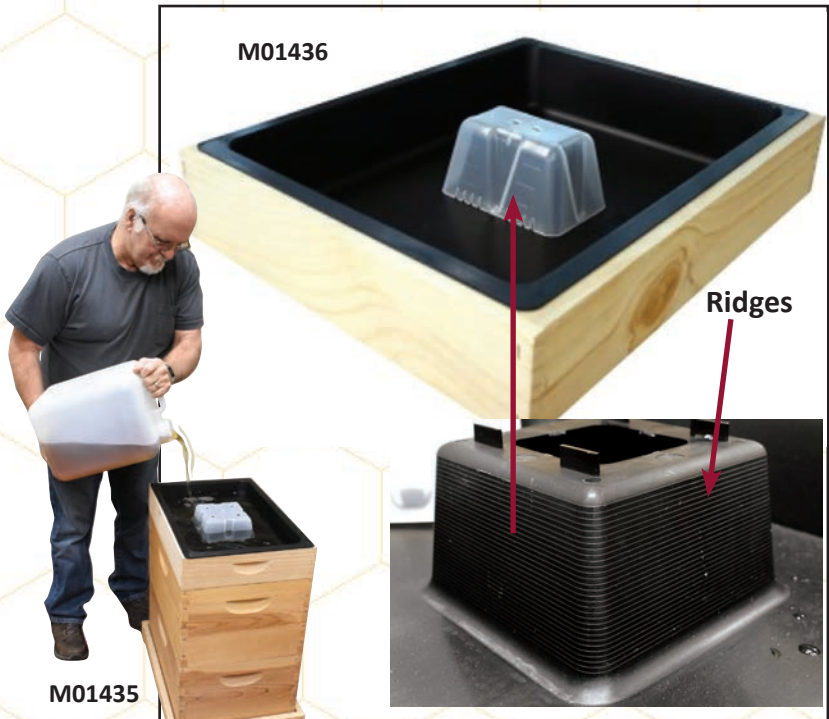

M01435



Wooden Hive Top Feeder

This 8-frame wooden pine feeder is the best we have seen on the market. All joints are caulked with 100% silicone to ensure proper sealing and the bottom is made out of urethane coated maple plywood for durability against moisture. Wooden floats help keep drowned bees to a minimum.

- M01454** 10-Frame, Actual wt. 7.3 lbs. ea. **\$36.95**
- M01453** 8-Frame, Actual wt. 6.12 lbs. ea. **\$35.95**



M01452

Assembled



M01438

Easy Grip One Gallon Feed Can

The Easy Grip One Gallon feed can is made of high density polyethylene and molded here in the U.S.A. Replaces the older metal cans used by many commercial beekeepers. Come with pre-punched lids. No need for paint as these won't rust.

- M01438** Actual wt. 7.2 lbs. ea. **\$10.95**

Wooden Nuc Top Feeder

This 5-frame pine nuc feeder is the best we have seen. All joints are caulked with 100% silicone to ensure proper sealing and the bottom is made out of urethane coated maple plywood for durability against moisture. Wooden floats help keep drowned bees to a minimum.

- M01452** Actual wt. 5.04 lbs. ea. **\$33.95**

BEE FEEDERS

Bee Buffet Feeder



A feeder designed for either open or hive top feeding, of both liquid food (sugar water) and pollen patties. This feeder can be used with large or small mouth pint and quart mason jars. Feeder includes base, cover, small and large jar bands and lids, and a patty cup.

M01455 Bee Buffet Feeder \$14.99

9⁵/₈" Division Board Feeder

Finally a division board feeder that virtually eliminates drowned bees. **Heavily ribbed** interior gives bees a perfect foothold while climbing in or out. Extra thick sidewall construction puts more material where it's needed for years of use. Holds approx. 1 gallon. *Exclusive new condensation points — channels moisture away from feeder. Fits 9⁵/₈" deep body hive. Also available for 6⁵/₈" super. Actual wt. 1.2 lbs. ea.*

M00859 9 ⁵ / ₈ " Division Board Feeder	M00852 6 ⁵ / ₈ " Division Board Feeder
1-4 \$12.95	1-4 \$11.45
5-9 \$11.95	5-9 \$10.45
10-49 \$9.95	10-49 \$8.45
50-249 \$8.95	50-249 \$7.45
250-499 \$7.55	250-499 \$6.05
500+ Price — Call Local Branch	500+ Price — Call Local Branch

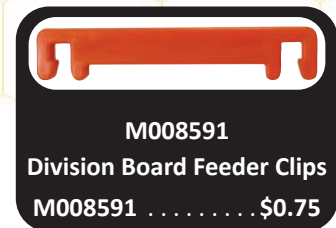

M008591
Division Board Feeder Clips
M008591 \$0.75



M00852
6⁵/₈" Division Board feeder

Frames/Hive/Nuc
not included



9⁵/₈" Division Board
Feeder placed in hive.
M00859

FEEDERS

NEW!



Bee Ladder

The Bee Ladder will keep your honeybees safe from drowning in the one gallon Dadant division board feeders. Easily snaps on and off for maintenance or cleaning of the feeder. Made out of durable plastic and hinged wings for easy maneuverability. Will store flat when not in use. Actual wt. 1.9 ozs. ea.

M008593 1-99 \$2.95
100+ \$2.50

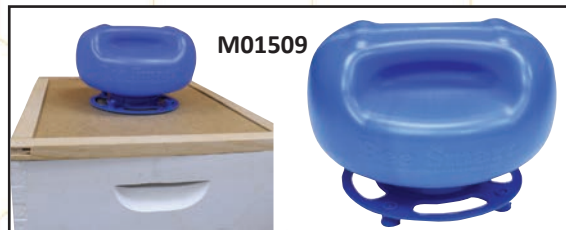

M01509

Ultimate Universal Feeder

Discover the 'Next Generation' Bee Friendly/User Friendly Universal Feeder. The feeder can be used with a feeder shell and placed without legs over inner cover hole to avoid bur comb. It can also be used as a community feeder.

M01509 Actual wt. 0.9 lbs. ea. \$30.95



M01457

EZ Nuc Feeder

The EZ Nuc feeder is just that EZ. The EZ feeder snaps into place on top of the Jester EZ nuc. Holds 2 quarts of sugar syrup. Actual wt. 1 lb. ea.

M01457 \$10.95



M59501

BeeMax Entrance Feeder

All-weather PVC entrance feeder is custom designed for use with your BeeMax insulated hive. Perforated metal cap is included with each feeder. Cap fits standard mason jar. Actual wt. 0.35 lbs. ea.

M59501 \$8.95

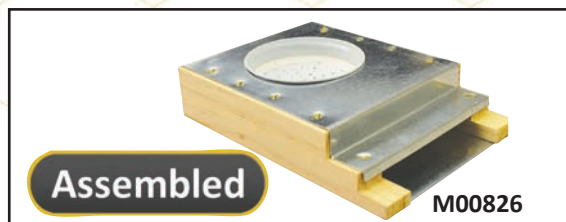

Assembled

M00826

Entrance Feeder — for wood hives

Our Entrance Feeder fits snugly into the entrance of the colony. Works best in warm weather (late spring, summer, early fall). Perforated metal cap is included with each feeder. Cap fits standard mason jar. Feed level visible at all times. Refill jar without opening hive. Actual wt. 0.45 lbs. ea.

M00826 1-49 \$7.49
c/50 ea., \$5.45

Actual wt. 22.5 lbs.

M00887 Replacement Cap Only,
(size G70), ea. \$1.75
Actual wt. 0.03 lbs.

BEE FEEDERS

4-Jar Feeder



This 4-jar feeder will keep you from having to refill jars every other day when introducing package bees or nucleus colonies. This will also come in handy when trying to get hives up to weight before winter. Place above inner cover hole and use a brood box as a shell. **Jars and lids not included.**

M00825 Actual wt. 1 lb. ea. \$19.95
 M00887 Feeder Lid Only, Actual wt. 0.03 lbs. ea. \$1.75

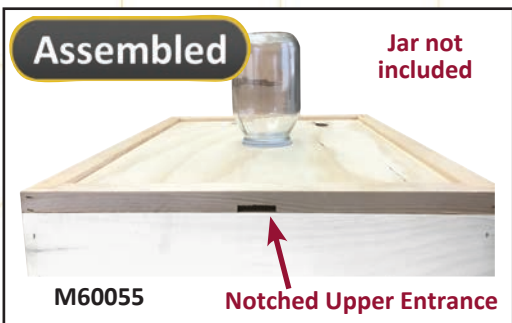

Plywood Inner Cover with Feed Hole

These inner covers work great to feed your colonies while keeping pesky critters including robbing bees away. Place an empty hive body on top to act as a shell and then your telescoping cover. Use a standard Boardman feeder cap in hole with a quart or 5 lb. jar of syrup. **Jar and lid not included.**

M60055 10-Frame, Actual wt. 2.05 lbs. ea. \$20.95
 M60050 8-Frame, Actual wt. 1.7 lbs. ea. \$20.95

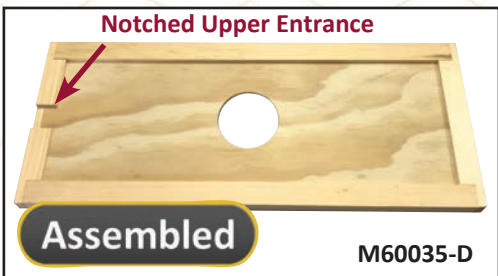

Plywood 4 & 5 Frame Inner Cover with Feeder Hole

Our nuc inner cover is the same one that comes with our support hive. It works well with both 4- and 5-frame nuc boxes. Place empty nuc box on top of inner cover to act as a feed shell. Invert feed jar in hole. Standard G70 Boardman Feeder lid fits hole. **Jar and lid not included.**

M60035-D Nuc Inner Cover with Feeder Hole, Actual wt. 1.1 lbs. ea. \$13.95
 M00887 Feeder Lid Only, Actual wt. 0.03 lbs. ea. \$1.75



Plywood Nuc Top Cover Only

This 5-frame nuc cover is fully assembled. G70 feeder cap fits the hole in the center and makes feeding your start up colonies a breeze. **PAINTING IS REQUIRED.**

M60030 Plywood Top Cover only, Actual wt. 2.4 lbs. ea. \$14.95



Feeder Jars — Glass 3 LB. Quart Jar and 5 LB. Round Jar

We have been using these 3 lb. quart and 5 lb. round jars as feed jars for many years. Easy to clean and refill, these can be used with our 4-jar feeder, our new plywood inner covers with feed hole and for your honey storage needs. Each jar makes a great container for honey and some use them exclusively for their payments to the landowner of the property the beekeepers hives are sitting on. It is also known as a yard rent jar. Both take a standard G70 closure.

✘ M001931 3 LB Jar Carton/12 \$22.50 Actual wt. 10.78 lbs. ea. ✘ M001921 5 LB Jar Carton/6 \$30.85 Actual wt. 8.96 lbs. ea.

M00887 Feeder Lid Only, Actual wt. 0.03 lbs. ea. \$1.75



2-Gallon White Plastic Pail

These 2-gallon pails work great at a feeder. Punch 10 pin holes in center of lid. Invert bucket over inner cover hole. Use with hive body as a shell.

M00238 Actual wt. 1.08 lbs. ea.
 1-99 Pails \$5.75 ea.
 100+ Pails \$5.50 ea.

Bucket Bee Raft (2 and 5 Gallon)

Easy and fast way to feed your bees. This open air community feeder comes in two sizes.

M014552 Fits 2 gallon bucket, Actual wt. 0.3 lbs. ea. \$13.60
 M014555 Fits 5 gallon bucket, Actual wt. 0.4 lbs. ea. \$15.45

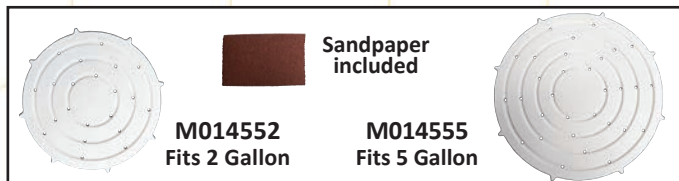

FEED ADDITIVES

Nozevit plus

Nozevit Plus incorporates the original highly popular Nozevit product and adds additional whole plant polyphenols aimed at the longer term health of the honey bee while maintaining the same application rate and methodology. It is an all-natural product helping to promote and maintain the intestinal integrity of the honey bee along with the long-term health and vitality of your bees.

- M01955** - 2 fl. ozs., Actual wt. 0.15 lbs. ea. . . . \$24.95
- M01956** - 8.45 fl. ozs., Actual wt. 0.65 lbs. ea. **\$98.95**
- M01958** - 32 fl. ozs., Actual wt. 2.45 lbs. ea. . **\$259.95**



Recommended feeding for Nozevit

- ½ quart or approximately 10 ounces of light syrup with 1 ml of nozevit or 20 drops
- Apply by either drenching or spraying syrup directly on top of frames in hive
- For preventive care we recommend feeding your bees two times, 10 days apart in spring, fall and during summer nectar dearths.
- For bees under extreme stress feed four times at 4 days apart
- Add to your pollen patties. 20 drops per pound or for the larger beekeeper 500 ml to 310 lbs. of dry product.
- Always store unused Nozevit in a cool dark location

◊ 2 fl. oz bottle of Nozevit will feed 50 hives one time when mixed into 4 gallons or 15 liters of syrup
 ◊ 8.45 fl. oz bottle of Nozevit will feed 250 hives one time when mixed into 22 gallons or 83 liters of syrup
 ◊ 32 fl. oz bottle of Nozevit will feed 1000 hives one time when mixed into 88 gallons or 333 liters of syrup

SuperDFM

SuperDFM® provides healthy bacteria to the bee's digestive tract, optimizing digestion, nutrient absorption, and strengthening immunity. SuperDFM®-HoneyBee™ is an all-natural and completely safe probiotic supplement. Accepted for organic use. No Preservatives. No Animal Ingredients. Non-GMOs. No Resistance Build-up!

- Stimulates Bee Health, Digestion, and Nutrition
- Suppresses Chalkbrood (*Ascoaphera apis*)
- Increase Nurse Bees' Performance
- Establish Beneficial Microflora
- Supports Strong Colony Health!

- M01933** - 100 gr. **\$21.95**
Actual wt. 0.25 lbs. ea.
- M01934** - 500 gr. **\$67.95**
Actual wt. 1.2 lbs. ea.



Complete

"Complete" contains full strength Nozevit, Optima and Bee Cleanse. The most "complete" food additive on the market containing more than 14 essential oils, amino acids, vitamins and minerals. One liter will feed up to 200 colonies by drenching or 400 colonies in sugar syrup.

- M01932** - 3.38 ozs. **\$21.95**
Actual wt. 0.3 lbs. ea.
- M01923** - 32 ozs. **\$97.95**
Actual wt. 2.85 lbs. ea.

✗ M01935 - 5 gallon pail **CALL**
Actual wt. 57.7 lbs. ea.*

May not be available at all branch locations.

Hive Alive

Hive Alive is a feed enhancer combining natural bio-active ingredients which promote intestinal well-being and improved colony strength. Hive Alive contains a blend of unique seaweeds, scientifically selected for honeybee health. Offered in two sizes — The 100ml feeds up to 10 hives and the 500ml feeds up to 50 hives..

- M02003** - 100 ml **\$28.95**
Actual wt. 0.3 lbs. ea
- M02004** - 500 ml **\$93.95**
Actual wt. 1.2 lbs. ea.



Honey-B-Healthy

Honey-B-Healthy was developed in 1995 by a commercial beekeeper. Rich in specially processed essential oils, many large commercial beekeepers use it to fortify colony health and build resistance to the problems prevalent in today's apiaries. Easy to administer by either feeding or the dousing method. Honey-B-Healthy can be added to a spray and used in place of smoke. Skilled beekeepers find it useful to build up weak colonies and when combining colonies.



M01909 M01911 M01910

M01909 - 16 oz., Actual wt. 1.4 lbs. **\$33.95**
Makes up to 25 gallons of feeding mix

M01910 - 1 gallon, Actual wt. 1.55 lbs. . . . **\$139.15**
Makes up to to 220 gallons of feeding mix

M01911 - 5 gallon, Actual wt. 57.7 lbs.* **CALL**
Makes up to 1,100 gallons of feeding mix
Ships Freight Only *See page 136

**USED BY MANY OF
 THE WORLD'S LARGEST
 COMMERCIAL
 BEEKEEPERS.**

Vitamin-B-Healthy™

VITAMIN B HEALTHY™: used as a feeding supplement. Can be used alone in syrups, protein patties and along with Honey-B-Healthy and Amino-B-Booster to help strengthen colonies weakened from disease, pesticides and pollen stress. Helps provide needed nutrients vital for bee health and helps build strong healthy colonies for maximum honey production and pollination. Can also be used to help build up weak, over-winterized colonies, packages, nucs and swarms. Especially beneficial when bees are producing brood and available pollen sources are limited in quantity and/or the pollen is lacking essential vital nutrients causing dying yellowing (snot) brood and dwindling colonies.

M01939 16 oz. Vitamin-B-Healthy
 Actual wt. 1.4 lbs. **\$33.95**



M01939

Honey-B-Healthy® Super Plus

HONEY-B-HEALTHY Super Plus: is a special essential oil emulsion and when used with Honey-B-Healthy, Amino-B-Healthy and/or Vitamin-B Healthy, produces a synergistic (amplified) effect. When used alone, Super Plus has been shown to help keep hives cleaner while improving overall colony health. We have observed that, when combined with any combination of other Honey-B-Healthy products, Super Plus will accelerate consumption of the feeding mix. While any of our products can be used by themselves, we do advise that Amino-B Booster be combined with Original Honey-B-Healthy or Honey-B-Healthy Super Plus to help keep this liquid protein stable. (Amino-B Booster provides the protein amino acids the bees need). Vitamin B Healthy provides the bees with needed vitamins and minerals. All of our products are made of food grade ingredients in an FDA registered food manufacturing facility. However, they are not intended for human consumption.

M01937 16 oz. Honey-B-Healthy Super Plus
 Actual wt. 1.45 lbs. . . . **\$35.95**

M01938 1 Gallon Honey-B-Healthy Super Plus
 Actual wt. 11 lbs. lbs. **\$139.45**



M01937 M01938

Amino-B Booster

Protein Benefits:

- Stimulates brood rearing when there is no natural pollen or nectar
- Stimulates a nectar flow and pollen bloom when using 1:1 sugar syrup with HBH plus protein
- Provides all vital amino acids, plus 9 more
- Adds many health benefits especially with the HBH; larger, more robust and hardy bees
- Reinforces worn out stored pollen for late winter brood rearing
- When fed in sugar water with HBH, stimulates rapid build-up of nucs, swarms, package bees and weak colonies
- Can be used to help produce high quality queens by providing protein for royal jelly
- Can be used as a "Protein drench" when bees take pollen substitutes very slowly; just spray or drizzle the HBH-Protein into the cluster area; bees will clean it up, store it and use it

DIRECTIONS: Use 1 tbsp. (15 ml) to 3 tbsp. (45 ml) in a quart or liter of sugar water along with 1 tsp. (5 ml) Honey-B-Healthy® Feeding Stimulant with essential oils as a preservative. Best fed in inverted jars on top of the colony.

M01914 16 oz. Amino-B Booster
 Actual wt. 1.45 lbs. . . . **\$33.95**

M01915 1 Gallon Amino-B Booster
 Actual wt. 10.8 lbs. . . **\$139.95**



M01915 M01914

Fumidil-B

Fumidil-B —The only known registered treatment for nosema. Feed in sugar syrup during the spring and fall to keep your spore counts low. For dysentery.

- No residue in honey when used as directed.
- Cost effective. Reduces expensive colony replacement and results in more productive colonies.

Add 1 - 500 gram bottle to 1 gallon of water to dissolve. Makes 110 gallons of treatment when added to 110 gallons of syrup.

M0017025 Fumidil-B 25g, Actual wt. 0.15 lbs. **\$37.95**
M00170 Fumidil-B 500g, Actual wt. 1.3 lbs. **\$229.95**



M00170 M0017025

BROOD BUILDER

AVAILABLE IN PATTY OR DRY FORMULA

DRY FORMULATED FOR OUTDOOR DRY FEEDING



25 lb. bag — Dry
M0014625

5 lb. bag — Dry
M001465

If you live in some parts of California, the southwest or southern tier of the U.S., Brood Builder may be your answer to late winter or early spring outdoor dry feeding stimulation. If your bees can fly early in the year and collect Brood Builder, you can increase colony production.

Brood Builder must be protected from direct moisture such as rain, dew, fog and other inclement weather. Can be fed on platforms or trays directly in the bee yard. Honey bees collect Brood Builder because it is so close to pollen in nutritional value. Honey bees collect Brood Builder naturally, just as they would “real pollen.”

Directions for Use: Feed as is from the package on platforms or trays directly in the bee yard. Must be protected from direct moisture, such as rain, dew, fog and other inclement weather. Fill feeders often.

DRY

M001465 5 lb. Dry Quantity, Actual wt. 5.45 lbs. \$22.95

M0014625 25 lb. Dry Quantity, Actual wt. 25.2 lbs. ea.
 1-5 25# Bags \$59.95
 6-10 25# Bags \$57.95
 11+ 25# Bags \$53.95

CAN'T SHIP OUTSIDE THE 50 U.S. STATES

WET MOIST PATTY FORMULA

Brood builder is a great feed to give your hive the boost it needs to increase the brood population. Mix with sugar syrup or fructose until you reach a cookie dough consistency then sandwich between two sheets of wax paper. Feed in-between brood boxes if running doubles and on top of top bars if running singles. Additional sugar can be added for faster consumption. If small hive beetles are a problem feed ¼ to ½ lb. patties and reapply as needed. Store extra patties in your deep freeze.

PATTIES

CAN'T SHIP OUTSIDE THE 50 U.S. STATES

Brood Builder Patties with Honey B Healthy

M0014610H 10 pack, Actual wt. 10.1 lbs. \$36.95

- ⊗ **M0014640H** 40 lb. carton, Actual wt. 41.42 lbs.
 1-20 Boxes \$92.95 per box
 21-39 Boxes \$84.95 per box
 40-159 Boxes \$78.95 per box
 160+ Boxes CALL

Brood Builder Patties with Honey B Healthy & Nozevit

- ⊗ **M0014640HHN** 40 lb. carton Actual wt. 41.42 lbs.
 1-20 Boxes \$104.85 per box
 21-39 Boxes \$96.95 per box
 40-159 Boxes \$91.95 per box
 160+ Boxes CALL

Minimum quantity of 40 pounds.
 May not be available at all branch locations.

**PERFORATED
 FOR QUICK BEE
 ACCESS**



**READILY BEE
 ACCEPTED**

AP23 WINTER PATTIES / WINTER ITEMS



Dadant was the first to bring you the winter patty and continues to manufacture the best feeds available for winter and spring build up. Our winter patties are available in 10 lb. and 40 lb. boxes. At 4% protein and 96% carbohydrates this became the perfect complete winter honey bee feed.

M0016010PHW Actual wt. 12.05 lbs.
Ctn/10 patties **\$31.95**

M0016040PHW Actual wt. 41.42lbs.
Ctn/40 1-9 **\$94.95**
10-35 **\$89.95**
36+ **CALL**

CAN'T SHIP OUTSIDE THE 50 U.S. STATES

Get your freshly made winter patties today to have strong healthy hives come spring!

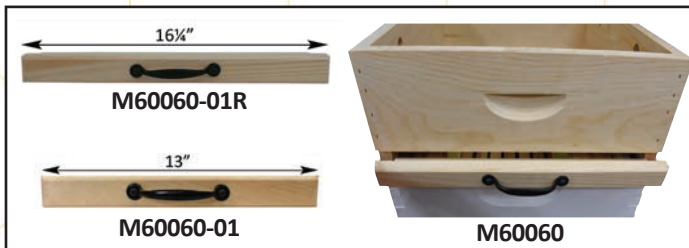

Moisture Box

Place wood chips, burlap, or cotton on hardware cloth to wick away condensation. Front door can be removed to feed winter patties without disturbing the colony. Four ventilation ports on the box help regulate air flow.

M60060 Moisture Box 10-Frame, Actual wt. 6 lbs. **\$54.95**

M60060-01 10-Frame Handle Replacement Assembly,
Actual wt. 0.5 lbs. **\$9.99**

M60060-01R 10-Frame Handle Replacement Assembly,
Actual wt. 0.5 lbs. **\$9.99**

M600608 Moisture Box 8-Frame, Actual wt. 6 lbs. **\$54.95**

M600608-01 8-Frame Handle Replacement Assembly,
Actual wt. 0.5 lbs. **\$9.99**



Candy Boards

We are pleased to offer candy boards to make feeding your bees a snap without disturbing your hive. Simply place your AP-23 Winter patties or homemade fondant in the candy board to provide extra food as needed through the colder temperatures. These candy boards also have ventilation ports to allow extra moisture to escape as temperatures fluctuate.

M01459P 10-Frame, Painted, Actual wt. 2.3 lbs. . . **\$22.50**

M01458 8-Frame, Actual wt. 2.2 lbs. **\$22.50**



10-Frame Bee Cozy Insulated Winter Wrap

Brought to you from our Canadian friends at NOD apiaries this two story bee cozy is sure to keep your bees warm all winter long. Slips over two double deep 10-frame boxes.

R8 value.

M61005 Bee Cozy Winter Wrap
Actual wt. 3 lbs. **\$40.95**



Easy-On Bee Hive Covers

Wrapping your hives for winter is one extra precaution we recommend. These are available in both 8- and 10-frame sizes and cover two deep boxes. With an R value of 4 these wraps are sure to keep your bees warm all winter long. Velcro strip for easy on/off.

M610010 10-Frame
Actual wt. 4.2 lbs. **\$43.75**

M61008 8-Frame
Actual wt. 4.2 lbs. **\$43.75**



AP23[®]

PATTIES WITH
HONEY-B-HEALTHY



BEST BEE NUTRITION ON THE MARKET

At Dadant & Sons we strive to bring you the best pollen substitutes available. After 4 years of working with two of the best nutritionists in the world, we are excited to bring you AP23. AP23 stands for artificial pollen and is the 23rd formulation to be developed and tested to date. It is formulated to deliver all of the currently known nutritional needs of the honey bee, with optimal balance of nutrient levels, in a highly palatable blend of specifically selected ingredients. If you have tried the other pollen substitutes on the market you owe it to yourself to try the best. Available in both dry and patty form.

AP23 is a high protein feed developed for all levels of beekeepers. It helps maintain colony strength by boosting populations, which result in better crop pollination and honey crops.

Guaranteed Analysis	
Crude Protein, min.	47%
Crude Fat, min.	3.5%
Crude Fiber, max.	3%
Moisture, max.	12%
Guaranteed analysis is for dry AP23	

**CAN'T SHIP OUTSIDE
THE 50 U.S. STATES**

**Feed AP23
For a
Healthy Bee!**

Available in both dry and patty form. Check your local branch for pricing

AP23 Patties

M001602PH - 2 pack Actual wt. 2 lbs.	
.....	\$13.99
M0016010PH - 10 pack Actual wt. 10.5 lbs.	
1-3	\$39.95
4-10	\$38.95
11+	\$38.25
M0016040PH 40#/ Patties Actual wt. 41.42 lbs.	
1-9	\$101.95
10-35	\$92.95
36-159	\$84.95
160+	CALL

AP23 Dry

M0016005 Dry 5# bag Actual wt. 5 lbs.	
1-10	\$27.95
11-up	\$27.50
M0016040 Dry 40# bag Actual wt. 40.82 lbs.	
1-3	\$92.95
4-10	\$90.95
11-39	\$85.95
40-159	\$81.95
160+	\$78.95
M001601500* 1 tote	\$2,375.00
*See page 136	
Totes may not be available at all branch locations.	

AP23 VS Competition:

1. Consumption rates are 2-3 times greater than all other pollen subs in our trials.
2. Optimal particle size for better digestibility. Digestibility estimated at 98+%.
3. All ingredients are from single manufacturing sources with known production parameters for improved consumption and digestibility.
4. Specific proteins used are isolated for purity — this means reduced indigestible sugars and other naturally occurring compounds that the bees cannot utilize.
5. Developed using computerized formulation program and based on specific nutrient needs of honey bees.
6. Formulated with bees preferred nutritional ingredients — based on 4 years of research with a wide variety of test diets.
7. Feed is consumed and stored by the bees. No signs of wasted feed on bottom boards or being drug out of hives as seen in other commercially available pollen subs in our trials.
8. Increase in certain amino acids help increase consumption.
9. Natural antioxidants and natural flavors.
10. Certain ingredients are added that may help optimum gut/bee health.
11. Repeat purchases by commercial beekeepers who report improved brood production and health.

AP23 WITH COMPLETE IS A SPECIAL RUN ITEM. Minimum quantity of 3200# or 72 – 40 lb. cases must be purchased for us to run them. This item is not stocked at any Dadant Branch location and will be ran upon receipt of the order. We recommend placing orders in advance of the Spring and Winter rush when able. Available FOB Hamilton, IL. Ships by LTL. *See page 136

AP23 with Complete (please see note at left)	
M0016040PC*	
72-144 cases ea.	\$108.95
145+ ea.	CALL

DISEASES, PARASITIC BEE MITES AND PREVENTIVE MANAGEMENT

The number of Parasitic Bee Mites and diseases affecting honey bees is not large. Of these, only a few are commonly serious enough to cause severe colony and financial losses to beekeepers.

However, in any consideration of bee disease, adopt a preventive attitude toward the treatment and management of bees. Accept the fact that disease can be costly in causing some degree in loss of honey crop, in diminished service as pollinating agents, in the cost of medications and labor expended for treatment and loss incurred in replacement of equipment and bees.

The Parasitic Bee Mites that have the most economic impact on beekeepers

are the Honey Bee Tracheal Mite (*Acarapis woodi*) which lives within the breathing tubes of the honey bee and the large Varroa (*Varroa destructor*) which is an external parasite which feeds on the hemolymph or blood of older larvae and pupae and adult honey bees.

Most diseases affect the honey bee in the larval stage of its development. American and European foulbrood are the two most common. AFB is the most virulent and destructive of the

two. Chalkbrood and sacbrood less frequently cause extensive losses.

Occurring nationwide, nosema is the major adult bee disease and is probably responsible for a greater loss of honey crops than any other disease. Its intensity fluctuates from place to place, year to year, and from season to season within a year. The peak level of infection shortens lives of the workers and reduces their ability to feed larvae during brood rearing.

Bee diseases have no physiological effect on people handling bees and equipment; eating honey, pollen, or comb from an infected colony; or using beeswax or beeswax products.

SUGGESTIONS FOR PREVENTIVE MANAGEMENT

Apiary locations, large or small, should be carefully selected. If possible, avoid a low, damp spot where puddles of water will stand. Diseases can be spread by bees getting water from such pools, which may contain feces from infected bees or pieces of dead larvae and bits of comb from sick colonies. A source of running water nearby is preferred. Low spots may also be comparatively stagnant as far as air movement is concerned. The humidity of the area builds up during the cool periods of spring and fall. Too much humidity also contributes to poor wintering.

Light shade (or no shade) is generally preferable to a heavy dense shaded location which remains damp long after a sunny spot has dried out. The bees will not fly as early in the morning, as late in the evening, nor as well on cool days if they are setting in a dense shade.

Hives should be arranged within the apiary to keep drifting of bees from one colony to another at a minimum. Keep hives as far apart as practical. Placing them in a random manner is preferable, even though they may not look as neat as when in a straight line, where each one is exactly so far from the next.

Placing hives beside small bushes or such will help bees mark the location

of their hive. Natural markers will also make it easier for any supersedure virgins to locate their respective hives when returning from mating flights, lessening the number of queenless colonies.

A hive stand raises the hive off the ground and serves two main purposes. First, the bottom of the hive is less likely to rot or be eaten by termites. Even painted bottoms will need replacing more frequently when allowed to rest directly on the ground. Secondly, from the disease viewpoint, a wet bottom board is likely to be an "incubator" for the development of causative organisms. Keeping the bottom clear of wax scales and other debris, also helps reduce the buildup of disease.

A $\frac{3}{4}$ " or 1" auger hole bored near the hand hold on the front of the hive will make a top entrance for the bees which will facilitate air circulation within the hive, reducing the buildup of humidity throughout the brood area.

Since honey is a bee disease-carrying medium for spores, etc., it should not be fed to any colonies unless you are absolutely certain the hive from which it came was free of disease. Honey purchased on the open market should never be fed to bees. There is no way of knowing what diseases you are buying in it.

Prolific queens, with a high percentage of egg hatchability so that every comb is filled solid with brood, are essential to maintaining strong colonies. Such colonies are less likely to become weak, rundown, and in turn, susceptible to diseases.

Transferring combs between colonies should be kept to a minimum. The same is true of shaking bees from one colony for boosting the weak or starting new ones. Be careful not to let honey from broken burr-combs drip on the ground when moving supers, etc. Not only is it possible to spread disease in this way, but it is a good way to get robbing started at times.

When you know the colonies are free of disease, moving combs of bees and brood is a good method of reducing the population of a crowded hive and building up a weaker one. Doing this with combs from newly purchased colonies is risky.

Wintering only healthy, strong colonies increases the probability of survival in good shape. Should a disease-weakened colony die before spring, whatever honey is remaining often will be robbed by other colonies—usually the strongest ones. They, in turn, will probably become infected.



VARROA DESTRUCTOR

MEDICATION GENERAL USAGE

The following is offered as a guideline for medication usage. Be sure to follow label directions in your treatment program.

For the beginning beekeeper, choosing the right medications and knowing when to use them can be tricky. Following is a chart we have devised to simplify and explain these treatments. If you ever have any questions in regards to what type of

medication to use, call your nearest Dadant branch and they will point you in the right direction. We also suggest ordering your medications early so you will be prepared when it comes time to apply.

MEDICATIONS/USAGE	LENGTH OF TREATMENT	METHOD OF APPLICATION	TIME OF YEAR TO APPLY
Apivar <i>Varroa</i> see pg. 58	42 days	1 strip for every 4-5 frames. Works by contact only. Place in high bee activity areas.	Normally used as fall treatment. Cannot be used with honey supers on.
Apiguard <i>Varroa</i> (Also benefits in the control of Tracheal mites) see pg. 56	Two treatments: 1st: 12-14 days 2nd: 2-4 weeks	Place delivery tray on top of top bar frames. A ¼" space is needed. Close off screened bottoms and vent holes.	Should be applied during the fall, unless infestation is severe. Temperatures 60°F-105°F. Don't apply when honey supers are on.
Apistan <i>Varroa</i> see pg. 57	42-56 days	1 strip per 5 frames of bees.	When temperatures are above 50°F, generally Spring and Fall.
Formic Pro <i>Varroa</i> see pg. 57	14 days	Apply two strips near the edges of the brood box.	14 days. Daytime temperatures must be 50-85°F.
Mite Away Quick Strips <i>Varroa</i> see pg. 57	7 days	Apply two strips near the edges of the brood box.	7 days. Daytime temperatures must be 50-85°F.
Tetra-B Mix/ Oxytetracycline <i>Foulbrood</i> see pg. 52	Three treatments 4-5 day intervals	Sprinkle recommended dosage around edges of brood box on top bars of frames. Once a week for 3 weeks.	Treat Spring and Fall.
Oxalic Acid <i>Varroa</i> see pg. 55	1 Treatment - 1 minute per hive	Use drenching or vaporizer methods.	Most effective early Spring or late Fall when there is little to no brood in the hive
Paramoth <i>Wax Moth</i> see pg. 59	3-4 weeks	6 Tbsp. for 15 supers, duct tape all openings making as air tight as possible. Reapply crystals as needed. Air out supers prior to placing on hive 1-2 weeks.	Apply as needed, particularly in warm weather.
B402 Certan <i>Wax Moth</i> see pg. 59	Mix one part of B402 to 19 parts water (5% solution). Apply after frames have been extracted. Apply to both sides of frame (1 oz. fluid for deep frames) (2/3 oz. fluid for medium) (1/2 oz. fluid for shallow) Allow to dry before putting into storage.		Apply once after extraction. Needs to be used before any wax moth infestation and will give protection through and until the next season. It will kill young wax moth larvae.
Fumidil-B <i>Nosema</i> see pg. 59	25 gram Treatment	Dissolve 1) - 25 gram bottle into 1 gallon of warm water. Mix Treatment into 5 gallons of syrup. Feed 2-3 times per hive if necessary.	
	50 gram Treatment	Dissolve 1) - 500 gram bottle into 1 gallon of warm water. Mix Treatment into 110 gallons of syrup. Feed 2-3 times per hive if necessary.	



Hive Inspection Sheet Notepad

Hive Inspection Sheets help to record hive activity, requeening, treatments, feeding, honey storage, honey extraction, and the condition of the hive. The notepad is made up of 25 sheets with pre-drilled holes to fit into a 3-ring binder. Actual wt. 0.4 lbs. ea.

M01940 Hive Inspection Sheet Notepad **\$4.95**

VETERINARY FEED DIRECTIVE (VFD) LAWS

On Jan. 1st 2017 the Veterinary Feed Directive went into effect. All customers must have a VFD from their veterinarian to be able to purchase Tetra Bee Mix for the treatment or prevention of American and European Foulbrood. A copy of the VFD must be filled out and signed by your veterinarian for the number of colonies you are wishing to treat. You will then send a copy of the VFD to your local Dadant Branch. Once Dadant is in receipt of the VFD, they can send the antibiotic to you. The VFD form can be sent via fax, mail, or email to your local Dadant office.

To make things go as smoothly as possible we suggest building a relationship with your local veterinarian. If they themselves are not beekeepers, you should invite them to your apiary and show them the ins and outs of the beehive. You will want to teach them that beekeepers can use Oxytetracycline in two ways. One of them is being proactive. This beekeeper uses oxytetracycline before a sign of disease is present. It is also used reactively or by treating when disease is found within the hive. You will want to teach them about the times of the year that it is applied and how many applications it takes when treating. Most who treat proactively will treat in the spring and the fall. Others will treat only when the disease is present. Treatment time frames are 3 – 200MG doses at 4-5 day intervals. A VFD can be written for a period of up to 6 months by your local veterinarian.

If you have any questions regarding VFD laws that we didn't answer above, contact your local Dadant office and our sales staff will do the best they can to answer your questions or put you in contact with those who can. There is a chance that this will be appealed and done away with for small animals which would include honey bees. Should that happen, we will make an announcement via email and on our website at www.dadant.com.

Veterinary Feed Directive

All parties must retain a copy of this VFD for 2 years after the date of issuance.

Veterinarian: Dr John Doe Client: Dadant Apiaries
 Address: _____ Address: _____
 (business or home)
 Phone: _____ Phone: _____
 Fax or email (optional): _____ Fax or email (optional): _____

Drug(s) Name: Oxytetracycline Drug(s) Level: 200mg/colony g/ton Duration of use: 3 times 4-5 day intervals
 Species and Production Class: Honey Bees No reorders (refills) authorized: N/A
 Indication for use (as approved): Foulbrood
 Caution (related to this medicated feed, if any): Not to be used during main honey flow

USE OF FEED CONTAINING THIS VETERINARY FEED DIRECTIVE (VFD) DRUG IN A MANNER OTHER THAN AS DIRECTED ON THE LABELING (EXTRA LABEL USE) IS NOT PERMITTED.

Approximate Number of **Bees/Hives**: _____
 Premises: (Address of where bees are located) _____
 Other Identification (e.g., age, weight) (optional): _____
 Special Instructions (if any): _____

Affirmation of intent (for combination VFD Drugs) (check box)*:

- This VFD only authorizes the use of the VFD drug(s) cited in this order and is not intended to authorize the use of such drug(s) in combination with any other animal drugs.
 This VFD authorizes the use of the VFD drug(s) cited in this order in the following FDA-approved, conditionally approved or indexed combinations(s) in medicated feed that contains the VFD drug(s) as a component.

Drug(s)	Drug Level(s) and any Special Instructions
Oxytetracycline	200 mg per colony 3-4 treatments each at 4-5 day intervals

- This VFD only authorizes the use of the VFD drug(s) cited in this order any FDA-approved, conditionally approved or indexed combinations(s) in medicated feed that contains the VFD drug(s) as a component.

◀ Withdrawal Time (if any): This VFD Feed must be withdrawn 48 days prior to **honey flow**. ▶

VFD Date of Issuance: _____ (Month/Day/Year)

VFD Expiration Date: _____ (Month/Day/Year)

Veterinarian's Signature: _____ (As specified in the approval; cannot exceed 6 months after issuance.)

FOULBROOD

DISEASE PREVENTION FOR HEALTHY BEES



Tetra-B Mix*

Tetra-B Mix is a ready-to-feed mixture containing the antibiotic oxytetracycline. Recommended as an aid in the control of American and European foulbrood. May be used for fall treatment of colonies prior to winter or for the spring treatment of overwintered colonies. Spread over the top bars of the frames in each section of the brood nest. All use should stop at least 6 weeks prior to a surplus honeyflow.



Bulk 10 lb. or 50 lb. bags.
Tetra-B does not expire.

- **READY TO USE**
- **NO MIXING**
- **CONVENIENT**
- **EFFECTIVE**

— Active Ingredient: Oxytetracycline —

M00161	10 lb. bags, 160 treatments, Actual wt. 10.2 lbs. ea.	
	1-4 bags	\$36.95
	5-49 bags	\$34.95
	50+ bags	CALL
M00163	50 lb. bags Actual wt. 50.2 lbs. ea.	
	1 bag	\$165.50

***cannot be shipped outside of the U.S.**



Terramycin™* — Concentrate

Terramycin antibiotic is a proven treatment for American and European foulbrood. Blend with powdered sugar to make your own medication. Early spring treatment is recommended with three one tablespoon applications in 5 day intervals. Spread over top bars of frames in brood nest area. Treatment must be stopped 6 weeks prior to main nectar flow. TM-100MR.

Terramycin 100MR

A bulk pack used by commercial beekeepers for treating large numbers of colonies. A 50 lb. bag when properly mixed with sugar feeds 4000+ colonies. 50 lb. bag

	M00176 Terramycin, Actual wt. 53 lbs. ea.	
	\$596.95

***cannot be shipped outside of the U.S.**

IPM MANAGEMENT

Cutts Beetle Blaster

Retired Florida State Apiary Inspector Laurence Cutts has come out with this disposable beetle blaster. Similar to the AJ's beetle eater at a portion of the cost. Fill with a small amount of vegetable oil and put in between top bar frames. We suggest two per box when infestations are severe. Discard after each use.

M01945 Regular size Beetle Blaster
Actual wt. 0.02 lbs.
1-49 **\$3.95**
50-99 **\$3.60**
100-999 **\$3.10**

M01952 Mini Beetle Blaster
Actual wt. 0.01 lbs.
1-49 **\$3.25**
50-99 **\$3.05**
100-999 **\$2.90**

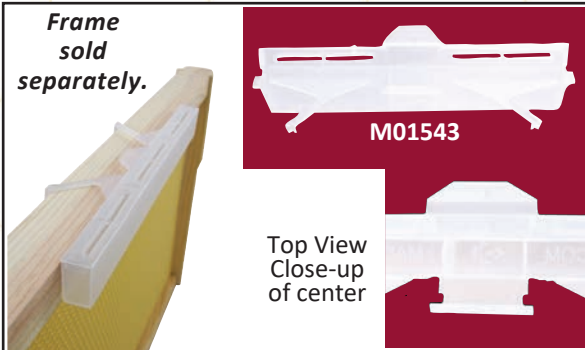

Reusable Beetle Trap

This in-hive re-usable trap comes with 3 trays to hold your favorite beetle bait, vegetable oil, or diatomaceous earth. Has a hinged lid for easy access to clean for re-use.

M01543 Reusable Beetle Trap
Actual wt. 0.05 lbs. ea. **\$4.35**



Beetle Bee-Gone

Beetle Bee Gone sheets are an all-natural, chemical free way to trap small hive beetles. Place one to two sheets per brood chamber where beetles congregate. Re-apply sheets the next time working these infested colonies and watch them disappear naturally. 48 sheets.

Color may vary — yellow or blue.

M01545 Beetle Bee-Gone, Actual wt. 0.01 lbs. ea. **\$11.95**

West Small Hive Beetle Trap

The 1st Small Hive Beetle Trap That Works!

The West SHB Trap was designed to sit on the bottom board just where SHB naturally like to hide. The trap consists of a tray that you partially fill with a small amount of vegetable oil and a specially designed lid that is covered with almost 300 small slots. The SHB, in looking for a place to hide from the honey bees trying to catch them, head for the slots as an escape route, which is a dead end that leads directly to the tray filled with thick non-toxic vegetable oil. The SHB falls into the vegetable oil, are coated with it, suffocate, and die. It's just that simple!

COMPONENT DIAGRAM



M01540 Beetle Trap Complete, Actual wt. 1.75 lbs. ea. **\$27.95**
M015401 Side Cleat for Beetle Trap, Each, Actual wt. 0.02 lbs. ea. **\$4.95**
M015402 End Cleat for Beetle Trap, Actual wt. 0.15 lbs. ea. **\$4.95**
M015403 Cleat Set for Beetle Trap, Actual wt. 0.75 lbs. ea. **\$5.95**
M015404 Beetle Trap Tray with Cover, No Cleats, Actual wt. 1.8 lbs. ea. **\$18.95**

INTEGRATED PEST MANAGEMENT (IPM) MANAGEMENT



Cypress Bottom Board with West Trap, Landing Board and IPM Board

This ultimate bottom board does it all. Made of Cypress this all-in-one bottom board will trap and kill SHB, allow you to check for mites with the IPM board, and give your bees a landing board to land on when coming back from foraging. Comes complete with West beetle trap and IPM board. Fully Assembled.

- M60040** 10-Frame Cypress Bottom Board, Actual wt. 5.5 lbs. . . \$43.95
- M60045** 8-Frame Cypress Bottom Board, Actual wt. 4.25 lbs. . . \$43.95

Assembled Varroa Screened Bottom Board

Provides a secure base, aids in the control of varroa mites and provides optimal ventilation for your colony.

- B92101** 10-Frame, Actual wt. 3.08 lbs. ea. \$29.65
- 5+ \$27.65
- B921018** 8-Frame, Actual wt. 2.76 lbs. \$29.65
- 5+ \$27.65

Replacement Boards

- B92101-01** 10-Frame, Actual wt. 0.34 lbs. ea. \$7.95
- 5+ \$7.75
- B921018-01** 8-Frame, Actual wt. 0.28 lbs. ea. \$7.95
- 5+ \$7.75

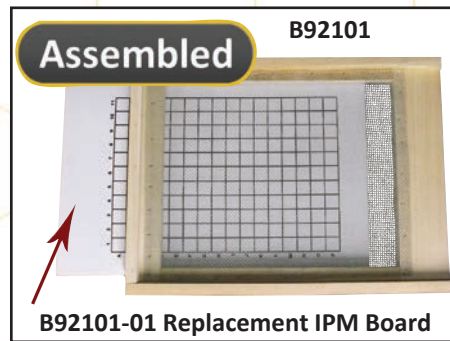

Ponderosa Pine Bottom Board & Varroa Screen all in ONE!

Bee Gym

The Bee Gym is a patented device to assist and improve grooming behavior in honey bees to help them to control varroa mite populations. Actual wt. 0.6 lbs.



- M01784** Bee Gym. . . . \$21.95

Varroa EasyCheck

The Varroa EasyCheck is an essential tool for reliable Varroa monitoring. All beekeeping outfits big and small should have one on hand for quick diagnosis of Varroa infestation levels.

Actual wt. 0.4 lbs.

- M014908** Varroa EasyCheck . . . \$25.95

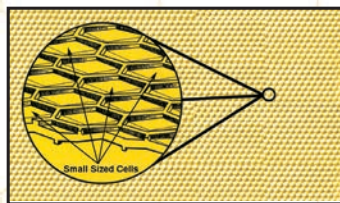

Dadant Small Cell Beeswax Foundation 4.9 & 5.1

It is a fact that varroa mites have a difficult time reproducing on worker brood raised in small cell comb. So, if you are an experienced beekeeper who has an experimental nature, this may be an opportunity for you to move ahead of the chemical control crowd with your honey bee management.

FOR PRICING SEE PAGE 16

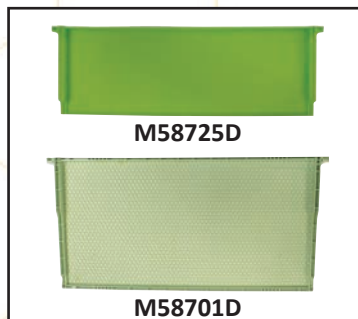

Drone Comb 6 1/4" and 9 7/8"

- M58725D** 6 1/4" coated drone comb
Actual wt. 0.55 lbs. 1-10. . . \$4.80
- M58701D** 9 7/8" coated drone comb
Actual wt. 0.75 lbs. 1-10 . . \$4.95

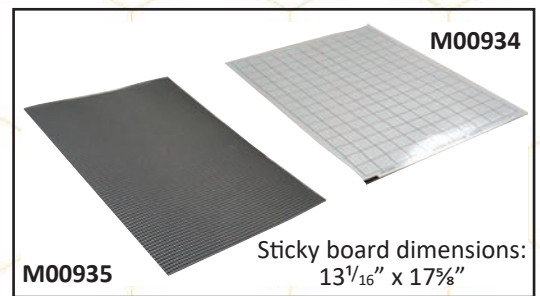

Varroa Screen

- Peel cover paper from adhesive board
- Place mesh screen over adhesive board
- Slide unit through existing entrance on bottom board
- M00935** Varroa Screen
Actual wt. 0.05 lbs. ea. \$4.35
- M00934** Sticky Board
Actual wt. 0.15 lbs. ea. \$5.35
- M00936** Screen & Board — Complete,
Actual wt. 0.2 lbs. ea. \$9.35

VARROA MITE MEDICATION

ProVap 110 Vaporizer

*We're talking 20 seconds per hive! No wand to insert, just point and shoot!
No guessing on dosage! No compressor or battery!*

Just plug it in to an inexpensive inverter, generator or use house current. The vaporizer is a 110 volt electrical appliance, 330 watts, 3.3 amps. This is the one you've waited for and now it's here!

M01766 ProVap 110 Vaporizer, Actual wt. 3.5 lbs. **\$524.95**



Oxalika Vaporizer

From our friends in Italy come the The Oxalika Vaporizer. It runs on a 12 volt battery and comes complete with two dosing spoons. This sublimator is the only one of its kind with a device to control the temperature of the heating cup which will increase efficacy that is lost by many other vaporizers on the market that run at higher temperatures. Treatment time is 1 minute 30 seconds. No need for cooldown between treatments. Made in Italy.

M01760 Oxalika Vaporizer, Actual wt. 1.9 lbs. **\$172.95**

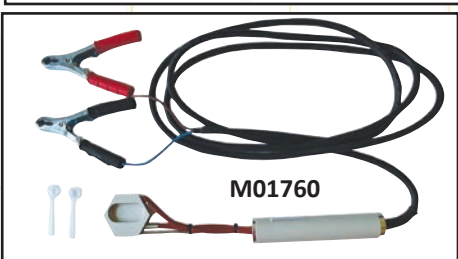

VarroVap Vaporizer

We are pleased to offer the VarroVap vaporizer. The VarroVap cannot be dunked in water. Wash with a wet rag or sponge in-between each application. Runs on a 12 volt battery.

M01780 VarroVap, Actual wt. 0.8 lbs. **\$149.95**



Oxalic Acid Safety Kit

Kit includes a pair plastic gloves, & plastic vent goggles for eye and hand safety. A syringe & metal scoop are also included to help in the application processes. It is also recommend to wear long clothing to avoid skin contact. Be sure to follow all safety guidelines and instructions on manufacturers label for oxalic acid.

Oxalic Acid sold separately.

M01774 Oxalic Acid Safety Kit, Actual wt. 0.31 lbs. **\$18.95**



Half Mask Respirator Kit

The 8000 Series Respirator conforms to the contours of your face. It seals comfortably and remains sealed, even while talking. Plus, the seal is extra-wide, so it fits more facial types. No inhalation valves to stock. No installation. Less maintenance, less parts. Cartridges snap-in, which eliminates mistreading. Plus, the weight is distributed evenly, without pressure points. The low profile provides a larger field of vision than any other respirator and makes it easier to wear safety eyewear. Be sure to review all fitting instructions and safety guidelines in the user manual prior to using this product. 2 cartridge filters included. Actual wt. 0.7 lbs.



M01769

M01769S - Small
M01769M - Medium
M01769L - Large
\$54.95

Replacement Cartridge Filters for Half Mask Respirator



Replacement filters (2-pack)
M01771

Organic Vapor/Acid Gases Replacement Cartridges for Half Mask Respirator. Easy to use Snap-In Replacement Cartridge Filters for Moldex 8000 Half Mask Respirator. Be sure to review fitting and safety guidelines prior to use. **2-pack.**
M01771 Actual wt. 0.5 lbs. **\$25.95**



M01764

M01758

Oxalic Acid*

Oxalic acid is a newly registered chemical control for Varroa Mites. Can be used in both drench and vaporization methods. Best used during broodless periods late fall through early spring, in packages, and nucleous colonies. Can be used on colonies during a honey flow with supers in place. Available in 3 sizes. **Recommended shelf life is within 5 years from actual manufacturing date if product is unopened and stored according to instructions.**

M01758 Oxalic Acid - 35 grams, Actual wt. 1.7 ozs. . . . **\$10.50 each**

M01764 Oxalic Acid - 350 grams, Actual wt. 13.1 ozs. **\$48.95 each**

***NOT AVAILABLE IN CALIFORNIA**

VARROA MITE MEDICATION



THERE MAY BE OTHER THYMOL PRODUCTS ON THE MARKET TODAY, BUT WE ARE PLEASED TO OFFER APIGUARD® FOR VARROA MITE CONTROL. WITH PROVEN EFFICACY, IT IS THE BEST THYMOL PRODUCT OFFERED IN THE U.S. TODAY.

A Vita-Europe Ltd. product by Dadant & Sons, Inc.

Foil pack contains 10 individual 50g treatments ready for application.

M01480 Apiguard® *
c/10 Foil Pack,
Actual wt. 1.35 lbs.
1-9 \$54.50
10 + \$51.50

***cannot be shipped outside of the U.S.**



Foil tray shown on brood frames.

Bulk tub comes complete with syringe and delivery pads.

M01481 Apiguard® Bulk Tub (6.6 lbs.)*
Contains 60 50g treatments in bulk gel form.

Actual wt. 7.49 lbs.
1-4 \$143.95
5-19 \$137.95
20-99 \$134.95
100-299 \$133.95
300+ \$127.95



M01481

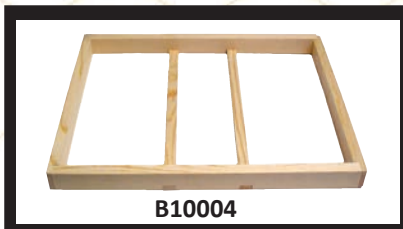

B10004

Use Rim & Sticks to allow for correct spacing

NAILS NOT INCLUDED

B10004 Rim & sticks come unassembled. Actual wt. 1.55 lbs.ea. \$5.95

VARROA: WAKE UP TO THE NATURAL EFFICACY OF APIGUARD®

A slow release thymol gel, a new and effective treatment

- A natural and non-toxic treatment
- Through thousands of treatments, efficacy rates ranged from 85% to 95%, with an overall average of 93%.
- It respects both the hive products and the consumer
- Encourages the hygienic behavior of the honey bee, preventing a number of related problems
- Resistance is controlled and unlikely to occur with Apiguard
- Ease of use: 2 x 50 gm treatment trays per hive, with an interval of 14 days, in summer just after the honey flow
- Best results occur when bees are active and maximum daily temperatures are between 60°F and 105°F.
- Though registered as a Varroa treatment, Apiguard has been proven to effectively treat Tracheal mites as well.

To Use Apiguard

Place the dosing tray or pad centrally on the top of the brood frames gel side up. Be sure to allow at least ¼" of spacing between the top of the tray and the cover using spacer boards or empty supers as needed. Apply the second dose 14 days after the first. Screened bottom boards should be closed while Apiguard is being applied.



Formic Pro*

Formic Pro is the next generation in formic acid treatments for mites. Made of all natural materials, this product can be used during the honey flow. Unlike Mite Away Quick Strips, Formic Pro has a longer shelf life and no temperature requirements for storage. Daytime temperatures still must be between 50°F - 84°F (10°C-29°C) when used.

Strips are to be placed across the top bars between brood boxes or on top of a single deep hive. Be sure to wear the recommended safety equipment for acid.

Treatment Options:

- 14 day Treatment: 2 strips for 14 days.
- 20 day Treatment: 1st strip for 10 days remove and replace with 2nd strip for an additional 10 days.

M01464	c/2 (4 strips total), Actual wt. 1.65 lbs.. . . .	\$20.95
M01465	c/10 (20 strips total), Actual wt. 7.2 lbs.. . . .	\$69.95
M01467	c/30 (60 strips total), Actual wt. 20.8 lbs.. . .	\$164.95

May not be available at all locations. Please call for pallet pricing. *cannot be shipped outside of the U.S.

Mite Away Quick Strips*

Mite Away Quick Strips are a Formic Acid polysaccharide gel strip which, when placed in the brood chamber of a honey bee hive, is an organic miticide that kills the Varroa mite where it reproduces under the brood cap. 2 strips per hive. Do not remove the white paper from the gel strips. Keep bottom entrances open the full width of the hive. Screened bottom boards can be left open if used along with top entrances. Treatment duration 7 days with daytime temperatures of 50-92°F.

May not be available at all locations.

Please call for pallet pricing.

***cannot be shipped outside of the U.S.**

M01461 c/10 (20 strips total), Actual wt. 7.19 lbs.. . . **\$62.95**

M01463 c/30 (60 strips total), Actual wt. 20.8 lbs.. . **\$153.95**



Apistan™ Strips*

Apistan Strips are a product developed specifically to control Varroa mites in honey bee colonies. There is no more convenient chemical method for beekeepers to use to kill Varroa mites.

For complete consistent control of Varroa mites use Apistan™ according to label directions.

Treatment For 5 Hives

M001261	Apistan Strips, 10 per pkg.,	
	Actual wt. 0.24 lbs. per pkg.	\$42.95
	10+ packages-per pkg.	\$40.95

Treatment For 50 Hives

M00126	Apistan Strips, 100 per pkg.	
	Actual wt. 2 lbs. per pkg.	\$291.95
	6+ packages-per pkg.	\$286.95



VARROA MITE MEDICATION



AMITRAZ CONTROLLED-RELEASE TECHNOLOGY

1. Amitraz is a sub-lethal miticide that paralyzes Varroa mites. Varroa cannot keep holding on to the bees and fall to the bottom of the hive, leading to their starvation.
2. Plastic polymer strip: specially designed to ensure a regular release of amitraz on the surface of the strip after its placement in the hive. The polymer strip was chosen for its rigidity and its ability to continuously release the active ingredient over a minimum six-week period.

HOW IT WORKS IN THE COLONY

Apivar works by contact: the active ingredient is delivered continuously over time. As bees walk on the strip's surface they pick up molecules of the active ingredient and then distribute them throughout the colony.



M014904	4 strips/pkg, Actual wt. 0.25 lbs.
1 pkgs.	\$18.95
M0149012	12 strips/pkg, Actual wt. 0.43 lbs.
1 pkgs.	\$51.95
10-49 pkgs.	\$49.95
M0149060	60 strips/pkg, Actual wt. 2 lbs.
1.	\$194.95
10-49 pkgs.	\$180.95
50+	CALL

***cannot be shipped outside of the U.S.**

"Apivar's polymer strip was chosen for its rigidity and its ability to continuously release the active ingredient over a minimum six-week period."

AVAILABLE AT ALL DADANT BRANCHES

Wax Moth*

Para-moth — A dry crystal that does an excellent job of keeping wax moths and their larvae under control. Place on top of a stack of stored supered combs. For 1 and 5 lb. quantities, branch pickup only is available. If shipped, product will ship from Hamilton, IL, ground only. **Additional charges may apply.**

M00142 (35 lb. quantity) ships LTL only or branch pickup only.

***cannot be shipped outside of the U.S.**

**Not available at all Dadant branches
(Not available in CA, HI, and MA)**

- ✗ **M00140** 1 lb., Actual wt. 1.5 lbs. ea. \$31.99
- ✗ **M00141** 5 lbs., Actual wt. 6 lbs. ea. \$89.99
- ✗ **M00142** 35 lbs., Actual wt. 38 lbs. ea. \$289.99



**Wax Moth
Damage**

Para-Moth Drawer AVAILABLE IN 10-FRAME AND 8-FRAME

These drawers are a convenient way to apply Para-Moth crystals as needed. Stack supers as you would normally store them for the season putting the Para-Moth drawer on top. Pull out the drawer to easily apply more Para-Moth.

- B93501** 10-Frame Para-Moth Drawer, Actual wt. 0.5 lbs.
..... \$30.95
- B935018** 8-Frame Para-Moth Drawer, Actual wt.3 lbs.
..... \$30.95

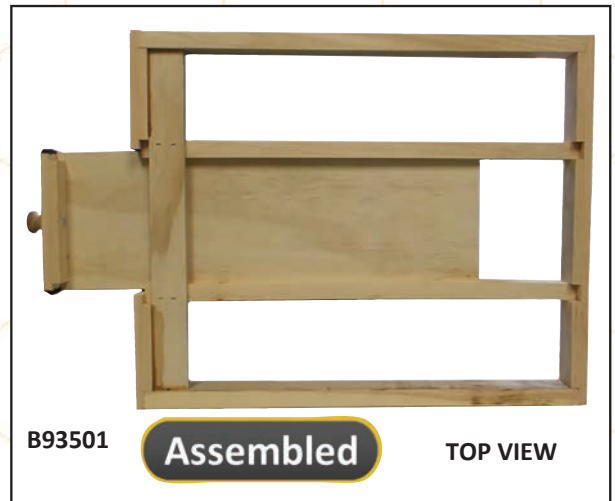

B93501

Assembled

TOP VIEW

B402 Certan

B402 Certan is the most advanced effective and economical product for the protection of your combs from damage by wax moths. It is a safe environmentally friendly product. It is a concentrated solution of Bacillus thuringiensis. It leaves no residues in wax or honey. Only one application needed for complete protection. Efficacy of up to 100% against wax moth larvae. It is used after the honey harvest, when the frames are stored. It must be used before a wax moth infestation. It will kill young wax moth larvae. A single application will provide protection against wax moth right up through to the following season. Applicators and mixers should wear long sleeve shirt, long pants, socks, shoe, protective eye wear and a NIOSH approved particle filtering respirator. Mix one part of B402 to 19 parts water (5% solution). Apply after frames have been extracted. Apply to both sides of frame, 1 ounce of fluid for deep frame, 2/3 ounce of fluid for medium frame and 1/2 ounce of fluid for shallow frame. Allow to dry before placing in storage. In warm conditions, once dry, supers should be protected from re-infestation by being wrapped or stored in an enclosed space.

- M02140** B402 Certan 5 oz., Actual wt. 0.5 lbs. \$38.95
- M02141** B402 Certan 1 quart, Actual wt. 3 lbs. \$199.95



M02140

M02141

SWARM PHEROMONES AND CATCH BOX

Swarm Commander Swarm Lure Crush Vials



M01998

A brand new product from Blythewood Bee Company. Swarm Commander Crush Vials are a new and easy way to bait your swarm traps. Simply remove the vial from the package. Crush the vial in the center until the internal glass vial breaks and the swarm commander fluid is released. Allow the fluid to absorb into the cotton plug. Swab the landing board of your hive as desired. After that, throw the lure into your box. Your hive will be baited for a minimum of 2 weeks (Tests show 20 days). Actual wt. 0.05 lbs.

M01998 Swarm Commander Lure Crush Vials. . . . \$18.50

Swarm Commander — Spray



M01982

Swarm commander spray is the perfect attractant to use when trying to catch swarms of bees. Spray the inside of your bait box with swarm commander and watch the bees come in. 100 applications per bottle. Actual wt. 0.15 lbs.

M01982 Swarm Commander Spray \$39.95

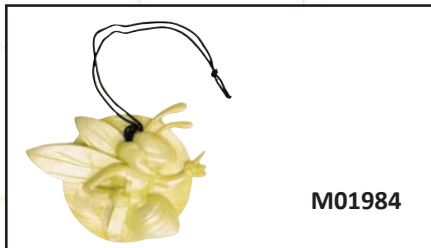

M01984

Swarm Commander Super Lure

This Swarm Commander Super Lure is huge. Creator Scott Derrick did it again with this awesome 90 day swarm attractant. Just hang it in your bait box and wait for the swarms to come. Actual wt. 0.1 lbs.

M01984 Swarm Commander Super Lure \$20.95

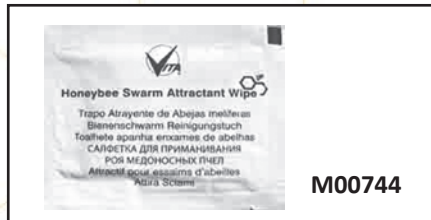

M00744

Swarm Lure

Vita Europe has come out with another great product. These swarm lures can be hung on the inside of your swarm box. Once opened, it is effective for 2 weeks then needs to be replaced. Hang at 6-8' off the ground. 10/box. Actual wt. 0.12 lbs.

M00744 Swarm Lure c/10. . . . \$25.50



M00741

Swarm Catch

Swarm Catch contains Nasonov: the orientation pheromone, sometimes called the "come hither" pheromone. On average, swarms will occupy 50-80% of catch boxes with Swarm Catch (provided there is a reasonable amount of swarming in the area). *Place Swarm Catch lure into an empty super with comb (comb should not contain honey). Store lures in the freezer until use.*

- Capture swarms from your own hives thus reducing loss of honey bees.
- Add to your hive count and honey yield by capturing stray swarms from other hives in the area.

M00741 2 Vial Pack, Actual wt. 0.1 lbs. ea. \$13.65

M00742 5 Vial Pack, Actual wt. 0.5 lbs. ea. \$24.95

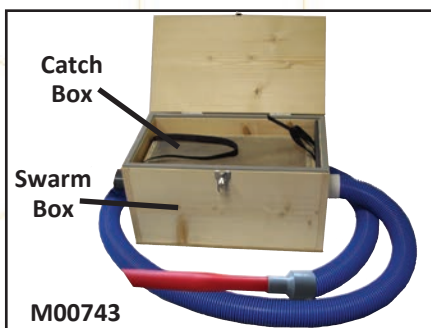

M00743

Swarm Box

Texas beekeeper Dwain Cleveland brought his swarm box to our attention. After seeing it in action, we thought we'd bring it to yours. Outer box connects to most shop vacs. Additional adapters may be needed as hoses will vary. Inner capture box holds approx. 3 lbs. of bees. More catch boxes may be needed, depending upon the size of the swarm you're trying to catch.

DVD included. Actual wt. 24 lbs.

M00743 Swarm Box. . . . \$226.55



M00743CB

Frames not included

Catch Box

For the larger swarm, more catch boxes may be needed. These are made to fit our swarm box only.

M00743CB Catch Box Actual wt. 4.25 lbs. . . . \$75.85



M60065

Entrance Excluder

The entrance excluder will keep your queen and drone bees inside the hive. Useful tool when seeing hives preparing to swarm in the spring. Place entrance excluder on front of hive with nails to pin it in place. Use while installing new packages and during the winter as your mouse guard.

M60065 Actual wt. 0.4 lbs. . . . \$10.95

NUC BOXES AND COMPONENT PARTS

Pro Nuc Box

The Pro Nuc design is superior to any others we have seen. With locking lid, 2 feed ports, great ventilation and closable entrance this nuc box is needed in your bee mobile. Currently available in 9 5/8" depth size. Actual wt. 3.2 lbs. ea.

✗ M01515 Pro Nuc Box,	
1-9	\$21.95
10-99	\$20.75
100-299	\$17.50
300+	CALL

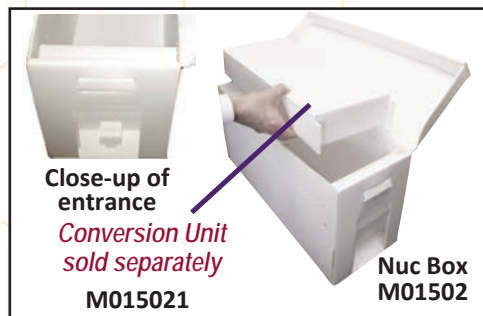

Jester's EZ NUC

Jesters EZ Nuc is made of one piece corrugated plastic for durability and strength. Great all around Nuc box.

✗ M01502	1-9	\$20.75
Jester's EZ NUC	10-99	\$17.95
Actual wt. 1.66 lbs.	100-299	\$16.75
	300+	\$15.25

Jester's EZ NUC Conversion Unit

✗ M015021 Conversion Unit to 6 5/8",	
Actual wt. 0.4 lbs.....	\$5.65

Wooden Nuc Box

Multiple Uses! Swarm Trap, Nuc Box, Split, Divides, Queen Production, Queen Mating Box and more. This small 5-frame lightweight nuc box is an easily transportable Ponderosa Pine nuc box that fills all those special needs that a heavy full size hive can't!

Frames sold separately.



B53401 Nuc Box,
Actual wt. 15.04 lbs. ea. \$64.95

Assembled Plywood Nuc 6 5/8" and 9 5/8"

Fully Assembled plywood nuc box is available in both 6 5/8" and 9 5/8" depth. These 5-frame boxes are perfect for making splits in the spring, summer and fall. Also works well as swarm boxes and for swarm removals. **PAINTING IS REQUIRED.**

M60015 6 5/8" Nuc Box,	M60020 9 5/8" Nuc Box,
Actual wt. 8.4 lbs. ea.	Actual wt. 18 lbs. ea.
1-28	1-28
\$27.95	\$28.95
29-58	29-58
\$26.95	\$27.95
59+	59+
\$25.65	\$26.65

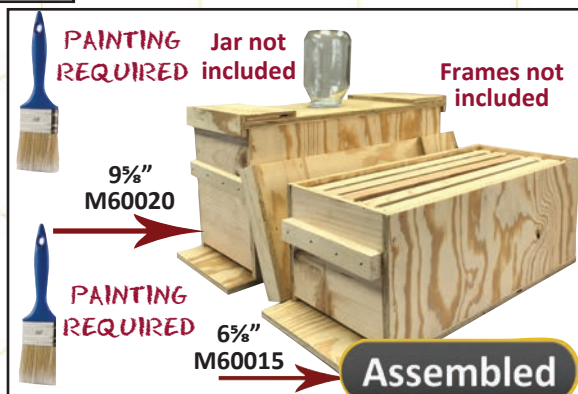

Plywood Nuc Top Cover Only

This 5-frame nuc cover is fully assembled. G70 feeder cap fits the hole in the center and makes feeding your start up colonies a breeze. **PAINTING IS REQUIRED.**

M60030 Plywood Top Cover only, Actual wt. 2.4 lbs. ea. \$14.95

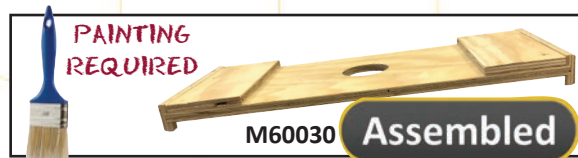

M60035-D

Plywood 4- and 5-Frame Inner Cover with Feeder Hole

Our nuc inner cover is the same one that comes with our support hive. It works well with both 4 and 5-frame nuc boxes. Place empty nuc box on top of inner cover to act as a feed shell. Invert feed jar in hole. Standard G70 Boardman Feeder lid fits hole. Feeder lid not included.

M60035-D Nuc Inner Cover w/ Feeder Hole,	
Actual wt. 1.1 lbs. ea.	\$13.95
M00887 Feeder Lid Only (not shown),	
Actual wt. 0.03 lbs. ea.	\$1.75

Nuc Screened Bottom Board — Assembled

Aids in the control of varroa mites and provides optimal ventilation for your nucs. Actual wt. 2.56 lbs. ea.

B92901NA Nuc Screened Bottom Board . . \$24.95

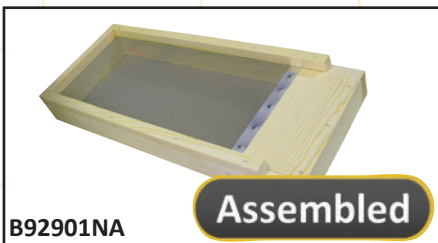

B92901NA

9 5/8" 5-Frame Nuc Box



Assembled

✗ B53210 Nuc Box
Actual wt. 7 lbs. ea.
\$22.95

QUEEN REARING, SUPPORT HIVES AND QUEEN INTRODUCTION

QUEEN REARING

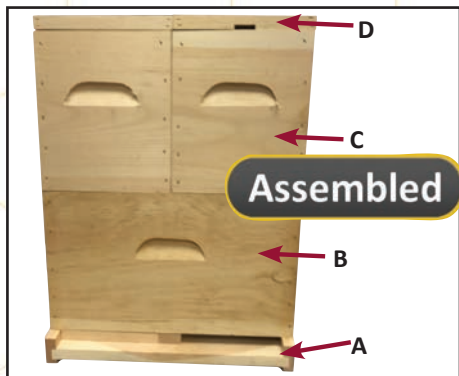

Assembled

Support Hive

Support hives are needed in every out yard you have. Two 4-frame hives make up the support colonies. Great for boosting a weak hive or for holding queens in case a replacement is needed. Entrances are on opposite ends to keep each colony from encroaching on the others territory. Comes with a special divided bottom board, single divided deep brood box, two 4-frame nucs and two inner covers with feed hole. Fully assembled and ready for a coat of paint. **Top covers and frames sold separately.**

- M60035** Support Hive, Actual wt. 27.25 lbs. ea. \$139.95
- M60035-A** Bottom board for Support Hive, Actual wt. 4.65 lbs. ea. \$31.95
- M60035-B** Deep box w/divider, Actual wt. 10.5 lbs. ea. \$35.95
- M60035-C** 4-Frame Nuc box for Support Hive, Actual wt. 4.9 lbs. ea. \$27.95
- M60035-D** 4-Frame Inner cover for Support Hive, Actual wt. 1.1 lbs. ea. \$13.95



B55101

Assembled

Queen Rearing Hotel

Our queen hotel is exactly what you need to continuously raise your own queens. Split into four 2-frame nucs or two 5-frame nucs. When you find a frame with a queen cell, put it and another frame into our queen rearing hotel and come back in a few weeks to find your mated queen or queens ready for placement into a split or queenless colony. You must use a standard 10-frame telescoping lid with this unit which is sold separately.

- B55101** Queen Rearing Hotel, Actual wt. 18.9 lbs. ea. \$64.95



Cloake Board

The Cloake board is a device invented by New Zealand beekeeper Harry Cloake to raise queens with a minimum amount of equipment. Consists of a wooden frame with queen excluder and metal tray and involves a series of stages which divide a colony into a queen right lower colony and queenless upper colony which improves acceptance of grafted larvae. Requires knowledge in grafting larvae. Full set of instructions provided.



Assembled

B41301

- B41301** 10-Frame Cloak Board, Actual wt. 5.6 lbs. ea. \$42.95
- B413018** 8-Frame Cloak Board, Actual wt. 5.06 lbs. ea. \$42.95

6 5/8" and 9 5/8" Follower Boards

Our 9 5/8" and 6 5/8" follower boards are just the ticket to help your small hive grow into its larger box. Use the follower board in place of a frame to condense a hive down and expand it as it grows. Great for small swarms and splits. Use your standard 10-frame hive and make it into two separate nuc boxes. Great for helping your apiary grow.

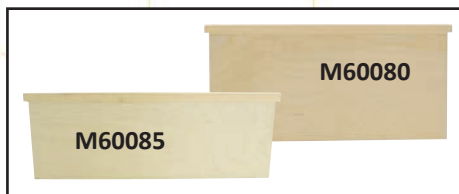

M60080

M60085

- M60080** 9 5/8" Follower Board, Actual wt. 2 lbs. \$8.25
- M60085** 6 5/8" Follower Board, Actual wt. 1.5 lbs. \$8.25

Double Screen Board

The double screened board makes requeening easy and efficient. When dividing a colony, remove your top chamber and place your double screen board on top of the bottom chamber and place your split on top of the double screen board. The older foraging bees will return to the bottom chamber leaving the younger bees, which will accept the new queen with much less stress. You can also replace the d/s with a queen excluder and run a double queen colony.

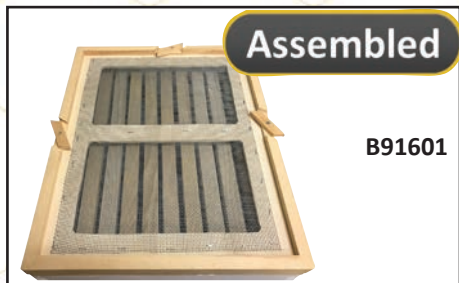

Assembled

B91601

- B91601** 10-Frame Double Screen Board, Actual wt. 2.1 lbs. ea. \$34.95
- 5+ \$32.95
- B916018** 8-Frame Double Screen Board, Actual wt. 1.62 lbs. ea. \$34.95
- 5+ \$32.95

Requeening Frame

Our re-queening frame will work with most wooden queen cages. This allows the queen to be readily accepted prior to being released. Be sure to remove the cork from the candy end and secure queen cage to frame.



M01592

Assembled

- M01592** Requeening Frame, Actual wt. 0.45 lbs. ea. \$17.95

Nuc Introduction Board

The nuc introduction board will help you unite your 5-frame nucs into a standard 8- or 10-frame colony. Place on top of your colony and cover with a sheet of newspaper. Spray the paper with sugar water and the bees will eat through the paper uniting the two colonies together. After a few days move the frames from the nuc into your standard box.



B41401

Assembled

- B41401** 10-Frame Nuc Introduction Board, Actual wt. 1.4 lbs. ea. \$13.95
- B414018** 8-Frame Nuc Introduction Board, Actual wt. 1.4 lbs. ea. \$13.95

RAISE YOUR OWN QUEENS WITH THE EZI QUEEN SYSTEM

EZI-QUEEN SYSTEMS

Queen rearing

The system assumes basic queen rearing knowledge, see below for book *Contemporary Queen Rearing* (M00065).



Shown on hive
(hive not included)



M01320

BENEFITS OF OUR QUEEN REARING SYSTEM

- 5 MINUTES to transfer eggs or larvae into 420 queen cells
- WITHOUT TOUCH! Our transfer of eggs or larvae makes this system unique to the industry
- No need for individual grafting
- Advanced technology utilizing easy-step lay cage design for high yield production of queen bees
- The EZI-Queen System comes ready to assemble for the hive

WITH OUR EZI-QUEEN REARING SYSTEM

- ✓ eggs are layed out within 4 hours
- ✓ eggs hatch to larvae within 72 hours and in 12 days your queens are ready to emerge



EZI Queen Manual

Instructional manual on how to use the EZI Queen Systems.

M01324M

Actual wt. 0.12 lbs.
\$16.95

Queen Bee Rearing System includes:

- 1-Lay Cage Unit
- 1-Front Cover
- 1-Front Cover Plug
- 1-Rear Cover
- 42-SNAP-OFF Plug Strips (10 plugs per strip)
- 21-Cell Bars
- 420-Individual Queen Cells
- Instruction Manual

EZI Complete System

Trap the queen with our push-in style cage and mark her as you normally would. No need to remove her from the frame. Less stress than other models.

M01320 EZI Complete System, Actual wt. 5.9 lbs. \$260.55

Replacement Parts for EZI Queen System

- M01321 42 SNAP-OFF Plug Strips, Actual wt. 0.2 lbs. . . \$22.95
- M01322 420 Queen Cells, Actual wt. 1.25 lbs. \$65.10
- M01323 Aluminum Bar (2 pc), Actual wt. 0.15 lbs. . . . \$5.95

Queen Paint Markers

USE THE CORRECT COLOR FOR THE YEAR YOUR QUEEN WAS INTRODUCED.

- Red — 2023
- Green — 2024
- Blue — 2025
- White — 2026
- Yellow — 2027

Standard Color Scheme: **White** color is for years ending in 1 or 6. **Yellow** color is for years ending in 2 or 7. **Red** is for years ending in 3 or 8. **Green** is for years ending in 4 or 9. **Blue** is for years ending in 5 or 0.

Actual wt. 0.05 lbs. ea.

- M01315 Yellow (2027) \$8.95
- M01316 Blue (2025) \$8.95
- M01317 White (2026) \$8.95
- M01317G Green (2024) \$8.95
- M01318 Red (2023) \$8.95



Queen Cell Protector

Queen cell protectors are to be used over the queen cells so emerging queens are confined. To be used with the EZI Queen System

M01326 Queen Cell Protector C/10, Actual wt. 0.25 lbs. . . . \$9.95



QUEEN REARING

QUEEN REARING TOOLS



M01946

Queen Marking Cage with Plunger

This queen marking cage will help you successfully mark your queens. Trap the queen in the cage and use the cushioned plunger to get her in place to mark. Use one of our queen marking pens to finish the job.

M01946 Queen Marking Cage w/Plunger
Actual wt. 0.1 lbs. \$7.50

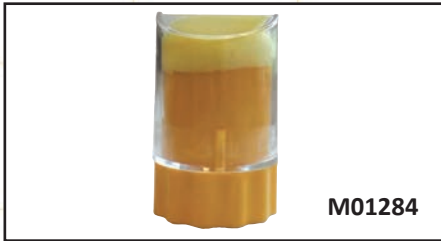

M01284

German Plunger

Great tool for marking queens. Gently place queen inside plunger and push toward the top. When in place use a marking pen to correctly mark her.

M01284 German Plunger
Actual wt. 0.1 lbs. \$7.50



M00653

Queen Clipping Scissors

M00653 Queen Clipping Scissors
Actual wt. 0.15 lbs. . . . \$20.50

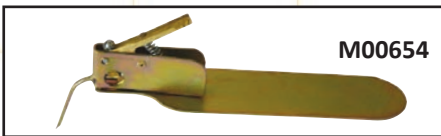

M00654

Master Grafting Tool

M00654 Master Grafting Tool
Actual wt. 3 ozs. ea. . . . \$59.95

M00655 Extra Tongues,
Actual wt. 0.06 lbs. ea. . \$6.95

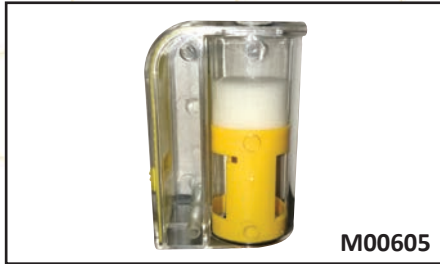

M00605

One-Handed Queen Catcher

This one-handed queen catcher makes picking up your queen by hand to mark a breeze. Safe and easy to operate.

M00605 One-Handed Queen Catcher
Actual wt. 0.6 lbs. . . . \$19.95

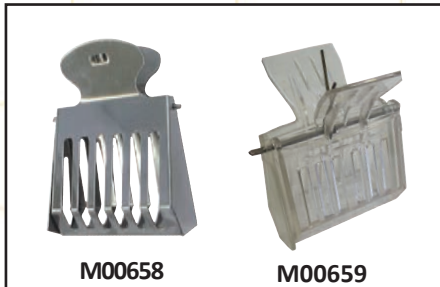

M00658

M00659

Queen Clip Catchers

Clips safely hold queen while working the hive. Designed so that worker bees can have full access to her.

Available in plastic or stainless steel.

M00658 Stainless Steel Queen Clip Catcher,
Actual wt. 0.05 lbs. ea. . . . \$8.95

M00659 Plastic Queen Clip Catcher,
Actual wt. 0.05 lbs. ea. . . \$6.95

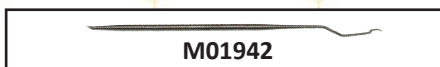

M01942

Economy Stainless Steel Grafting Tool

M01942 Economy SS Grafting Tool
Actual wt. 0.007 lbs. . . \$18.95

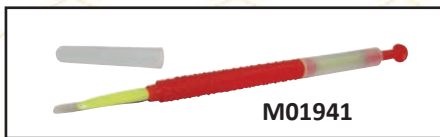

M01941

Plastic Grafting Tool

After many requests, here it is. The Chinese grafting tool is one of the easiest to use. The thin plastic tip slides up and under larvae and releases them when the end is pushed.

M01941 Plastic Grafting Tool
Actual wt. 0.03 lbs. . . . \$5.25



M01947

Push-In Queen Marking Cage

Trap the queen with our push-in style cage and mark her as you normally would. No need to remove her from the frame. Less stress than other models.

M01947 Push-In Queen Marking Cage
Actual wt. 0.02 lbs. . . . \$3.95



M01505

Entrance Disc

Using our entrance disc in your nuc operation allows you to have 2 entrances: one with a queen excluder opening; the other is wide open so the bees can come and go as they please. A third option is vented for moving bees from one location to another. Screws not included.

M01505 Entrance Disc
Actual wt. 0.05 lbs. . . . \$4.95



V01999

Queen Muff

Are you tired of losing queens when releasing the attendants? If you are, our queen muff is for you!

V01999 Queen Muff
Actual wt. 0.29 lbs. . . . \$20.95



M00652

JZ BZ Grafting Tool

M00652 Grafting Tool,
Actual wt. 0.05 lbs. . . . \$6.75

QUEEN REARING SUPPLIES

Works with wood or plastic cell bars



Bars not included

M61100

Assembled Queen Rearing Frame

Completely assembled 9" frame designed to hold three Plastic JZ-BZ Cell Bars or three Dadant Wood Cell Bars. Wide Cell Based cups will push into both the Plastic JZ-BZ Cell Bar as well as the Dadant Wood Cell Bar.

M61100 Queen Rearing Frame
Actual wt. 1 lb. ea. \$14.95

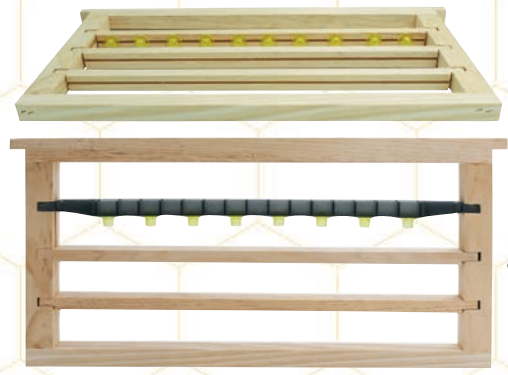

Shown with 3 wooden bars and wide base cell cups

Shown with Smokey bar and 2 wooden bars and wide base cell cups



M61105

Bar only (for Queen Rearing Frame)

Cell bars are designed to work with the Queen Rearing Frame. Bars have a groove cut to hold your Wide Base Cell Cups and can slide easily into the frame.

M61105 Bar only for Queen Rearing Frame
Actual wt. 0.1 lbs. ea. \$2.50

Queen Cage Holder

Fast, Easy, Accurate Placement of a Queen Cage.

Made from durable, yet flexible plastic which will last years. Each cage comes with instructions on how to use.
Actual wt. 0.02 lbs. ea.

M00679 Queen Cage Holder,
1-4 \$5.95
5-24 \$5.65
25+ \$5.15



Check out the video here!



M00679

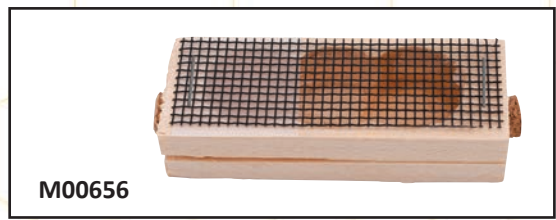

M00656

Wood Mailing Cages

(Without Candy) Carton of 100.

M00656 Wood Mailing Cages
Actual wt. 2.75 lbs. \$59.95



M00661

Queen Cage with large opening

The queen cage features a tapered candy tube, large overall opening, and secure closing mechanism for ease in use.
Actual wt. 0.02 lbs.

M00661 Queen Cage
1-99 \$.59 ea.
100+ \$.51 ea.

JZ BZ QUEEN REARING SUPPLIES

JZ BZ Smokey Cell Bar

The smokey cell bar holds 15 wide based cell cups. Attach bar to standard frame and place in cell building colony.



M00662S Smokey Cell Bar
Actual wt. 0.05 lbs. ea. \$3.95



Wide Base Cell Cups shown in Smokey Cell Bar (left) and frame (right)

JZ BZ Plastic Queen Cell Cups — 2 Styles



Push-In Cell Cups

M00663S Smokey	M00663S1 Smokey
M00663A Amber	M00663A1 Amber
M00663R Red	M00663R1 Red
M00663G Green	M00663G1 Green
M00663B Blue	M00663B1 Blue
c/100, Actual wt. 0.12 lbs.	c/1000, Actual wt. 1.5 lbs.
\$12.85	\$104.95



Wide Base Cell Cups

M00664S Smokey	M00664S1 Smokey
M00664A Amber	M00664A1 Amber
M00664R Red	M00664R1 Red
M00664G Green	M00664G1 Green
M00664B Blue	M00664B1 Blue
c/100, Actual wt. 0.2 lbs.	c/1000, Actual wt. 2 lbs.
\$12.85	\$104.95

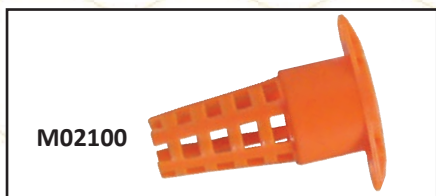

JZ BZ Top Bar Cell Protector

Hangs between top bars for easy access in and out of the hive.

M02100

M02100 Top-bar Cell Protector c/100, Actual wt. 0.02 lbs. \$16.50
M02100M Top-bar Cell Protector c/1000, Actual wt. 2.2 lbs. \$118.95

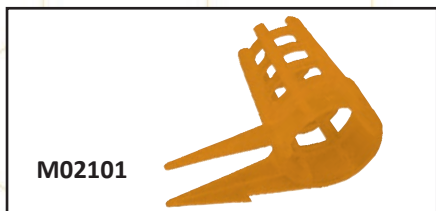

JZ BZ Push in Cell Protector

Push in for protection anywhere on drawn comb.

M02101

M02101 Push-in Cell Protector c/100, Actual wt. 0.2 lbs. \$16.50
M02101M Push-in Cell Protector c/1000, Actual wt. 1.7 lbs. \$118.95



JZ BZ Candy Cap

Use with our queen cage to help keep queens from emerging too early.

M02102

M02102 Candy Cap c/100, Actual wt. 0.13 lbs. \$13.95
M02102M Candy Cap c/1000, Actual wt. 1.3 lbs. 118.95

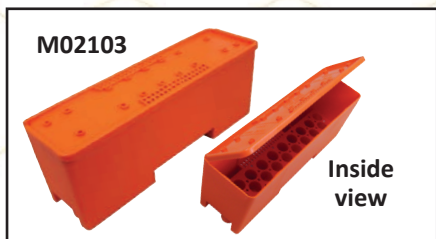

JZ BZ Queen Shipping Carton

Protects queen cells during shipment. Holds 20 queen cells.
Actual wt. 3.6 lbs. ea.

M02103

M02103 JZ BZ Queen Shipping Carton,
1-9 \$5.95
10-95 \$5.65
96+ \$3.50

ALL SUITS, JACKETS, TROUSERS — UNISEX SIZES



V01260L

V01260S

Suit

- V01260S – Small - Actual wt. 3.65 lbs.
- V01260M – Medium - Actual wt. 3.95 lbs.
- V01260L – Large - Actual wt. 3.95 lbs.
- V01260XL – X Large - Actual wt. 4.3 lbs.
- V012602XL – 2X-Large - Actual wt. 4.35lbs.
- V012603XL – 3X-Large - Actual wt. 4.35lbs.
- V012604XL – 4X-Large - Actual wt. 4.35lbs.

\$159.⁹⁵
each
V01260 Suit



V01261L

V01261M

Jacket

- V01261S – Small
Actual wt. 2.2 lbs.
- V01261M – Medium
Actual wt. 2.5 lbs.
- V01261L – Large
Actual wt. 2.6 lbs.
- V01261XL – X Large
Actual wt. 2.7 lbs.
- V012612XL – 2X-Large
Actual wt. 2.7 lbs.
- V012613XL – 3X Large
Actual wt. 2.7 lbs.
- V0126124XL – 4X-Large
Actual wt. 2.7 lbs.

\$131.⁹⁵ each
V01261 Jacket



Economy Vent Suit and Jacket

We are pleased to offer an economy ventilated suit and jacket. Three layers of ventilated netting are sandwiched together to provide you with optimum protection while allowing ultimate air flow keeping you well protected and cool. The suit offers extra padding at the knees, two chest pockets, two hive tool pockets, and side pockets. The jacket offers two chest pockets and two pockets by the waist. This suit also offers elastic wrists, elastic/zippered ankles and an elastic thumb hold. The ultimate in economy ventilated clothing.



V01251M

V01251S

Jacket

- V01251S – Small
Actual wt. 2.5 lbs.
- V01251M – Medium
Actual wt. 2.65 lbs.
- V01251L – Large
Actual wt. 2.75 lbs.
- V01251XL – X Large
Actual wt. 2.75 lbs.
- V012512XL – 2X-Large
Actual wt. 2.85 lbs.
- V012513XL – 3X Large
Actual wt. 2.75 lbs.
- V012514XL – 4X-Large
Actual wt. 2.85 lbs.

\$145.⁹⁵ each
V01251 Jacket

Ventilated Suit and Jacket

We are pleased to offer what we feel is the finest vent suit and jacket in the industry. Synthetic foam is sandwiched between 100% polyester mesh making this suit the coolest, most ventilated suit available on the market. The hat veil features an adjustable Velcro strap to help insure a true fit. Elastic cuffs around the wrist and ankles. Ankles are zippered for easy on/off. Two large pockets on front waist area and one on front chest provide room for needed tools. Suit has extra padding at the knees. Jacket offers elastic around the waist along with two large pockets and one large pocket on chest.



V01250M

Suit

- V01250S – Small - Actual wt. 4.1 lbs.
- V01250M – Medium - Actual wt. 3.85 lbs.
- V01250L – Large - Actual wt. 4.4 lbs.
- V01250XL – X Large - Actual wt. 4.4 lbs.
- V012502XL – 2X-Large - Actual wt. 4.65 lbs.
- V012503XL – 3X-Large - Actual wt. 4.65 lbs.
- V012504XL – 4X-Large - Actual wt. 4.65 lbs.

\$193.⁹⁵
each
V01250 Suit

BEEKEEPING SUITS

Dadant Zipper Veil Suit



Zipper Veil-Suit Combination was designed by *Dadant & Sons*. We added all the features our beekeepers wanted for total protection and comfort for a full day's work in the bee yard. This Zipper Veil-Suit Combination offers the fine features of the Dadant Folding Veil and the Dadant Coveralls to provide total protection for the beekeeper. Zippered side openings allow full protection and easy access to trouser pockets. Easily slip on over boots or shoes with generous zippered bottom pant legs. The location of the veil zipper holds the veil in place assuring perfect vision while allowing total freedom of movement. Easy on and off. We recommend using with the Dadant Plastic Sun Helmet. *When ordering, state catalog number and size. Because of numerous sizes, branch locations may be temporarily out-of-stock on some sizes.*

- M01103** – Small - Actual wt. 2.9 lbs.
- M01105** – Medium - Actual wt. 3.15 lbs. **\$103.⁹⁵ each**
- M01107** – Large - Actual wt. 3.1 lbs.
- M01203** – X-Large - Actual wt. 3.25 lbs.
- M01203X** – 2X-Large, Actual wt. 3.45 lbs. **\$106.95**
- M01203XX** – 3X-Large, Actual wt. 3.45 lbs. **\$106.95**
- M01203XXX** – 4X-Large, Actual wt. 3.45 lbs. **\$106.95**

Helmet not included,
(sold separately on page 73)

Snow-White Coveralls



Dadant coveralls are a snow-white, polyester-cotton blend. Snow-white because white is less annoying to bees than darker colors and they are less apt to sting. Full front zipper for easy on and off. Sturdy construction — all points of stress are bartacked for extra reinforcement. Six roomy pockets hold the tools you need. Side openings allow easy access to trouser pockets.

- M01063** – Small - Actual wt. 1.8 lbs.
- M01065** – Medium - Actual wt. 1.95 lbs. **\$67.⁹⁵ each**
- M01067** – Large - Actual wt. 2.15 lbs.
- M01121** – X-Large - Actual wt. 2.25 lbs.
- M01122** – 2X-Large - Actual wt. 2.3 lbs.

M01060

Boot Bands

Stop bees from crawling up pant legs. Sturdy 2" wide x 14 1/2" long bands with velcro are used to tighten pant legs against boots. Easy on and off. Boot bands are a must when wearing pants without elastic in the cuffs.

M01060 pair,
Actual wt. 0.1 lbs. ea. **\$4.50**
12+ pairs ea. **\$4.35**

Dadant Cricket Style Hat and Veil Suit and Jacket

We are pleased to offer both cricket style suits and jackets with poly-screen crush resistant veil. Both suits and jackets are made of a blend of polyester/cotton material. These are the ultimate in protection with added material in the knees and elbows. Suit offers a rear zippered pocket and two large front pockets which give plenty of room to carry what is needed in the beeyard. Ankles are zippered for easy on and off.



Cricket Style Hat & Veil Suit

\$129.⁹⁵ each

- V01230S** – Small – Actual wt. 2.85 lbs.
- V01230M** – Medium – Actual wt. 2.95 lbs.
- V01230L** – Large – Actual wt. 2.95 lbs.
- V01230XL** – X-Large – Actual wt. 3.05 lbs.
- V01230XXL** – 2X-Large – Actual wt. 3.2 lbs.
- V01230XXXL** – 3X-Large – Actual wt. 3.25 lbs.
- V01230XXXXL** – 4X-Large – Actual wt. 3.3 lbs.

Cricket Style Jacket

\$104.⁹⁵ each

- V01231S** – Small – Actual wt. 1.95 lbs.
- V01231M** – Medium – Actual wt. 2.05 lbs.
- V01231L** – Large – Actual wt. 2.1 lbs.
- V01231XL** – X-Large – Actual wt. 2.25 lbs.
- V01231XXL** – 2X-Large – Actual wt. 2.25 lbs.
- V01231XXXL** – 3X-Large – Actual wt. 2.3 lbs.
- V01231XXXXL** – 4X-Large – Actual wt. 2.2 lbs.





side view - hat flips back

COMFORTABLE HAT/VEIL FITS ALL WITH SPRING STEEL BAND RINGS TO KEEP THE VEIL OUT AWAY FROM THE HEAD.

V01220M

Hat-Veil Combo with Poly/Cotton Zippered Jacket

Featuring: Front zipper with elastic cuffs and waist and a zippered chest pocket. Easy to zip on and off for that quick hive inspection.

\$94.⁹⁵ each

- V01220S – Small - Actual wt. 1.7 lbs.
- V01220M – Medium - Actual wt. 1.8 lbs.
- V01220L – Large - Actual wt. 1.8 lbs.
- V01220XL – X-Large - Actual wt. 1.9 lbs.
- V01220XXL – 2X-Large - Actual wt. 1.85 lbs.
- V01220XXXL – 3X-Large - Actual wt. 2 lbs.
- V01220XXXXL – 4X-Large - Actual wt. 2.2 lbs.



V01220MP

Poly/Cotton Trousers

Our adult trousers are a nice compliment to our Hat-Veil Combo Jacket and Hooded Poly/Cotton Jacket. These trousers feature two large front pockets with velcro closures and an extra hive tool pocket on each side. The waist is a very stretchable elastic with front zipper and button up front. Zippered legs for easy on and off.

- V01220SP – Small
Actual wt. 1.2 lbs.
- V01220MP – Medium
Actual wt. 1.25 lbs.
- V01220LP – Large
Actual wt. 1.3 lbs.
- V01220XLP – X-Large
Actual wt. 1.4 lbs.
- V01220XXLP – 2X-Large
Actual wt. 1.5 lbs.

\$48.⁹⁵ each



V01170S

V01170M

Hat-Veil Combo with Poly/Cotton Suit

Featuring: Leg zippers for easy on/off, two front side pockets and a chest pocket. Comfortable hat/veil combo with zipper attachment, elastic leg and wrist cuffs.

\$113.⁹⁵ each

- V01170S – Small - Actual wt. 2.5 lbs.
- V01170M – Medium - Actual wt. 2.6 lbs.
- V01170L – Large - Actual wt. 2.6 lbs.
- V01170XL – X-Large - Actual wt. 2.6 lbs.
- V01170XXL – 2X-Large - Actual wt. 2.7 lbs.
- V01170XXXL – 3X-Large - Actual wt. 2.85 lbs.
- V01170XXXXL – 4X-Large - Actual wt. 2.95 lbs.



V01200M

For quick trips to the bee yard, a practical hooded jacket gets the job done. Secure, safe and cool.

Hooded Poly/Cotton Jacket

\$84.⁹⁵ each

- V01200S – Small- Actual wt. 2.1 lbs.
- V01200M – Medium- Actual wt. 2.2 lbs.
- V01200L – Large- Actual wt. 2.3 lbs.
- V01200XL – X-Large- Actual wt. 2.45 lbs.
- V01200XXL – 2X-Large- Actual wt. 2.55 lbs.

QUALITY IMPORTED AT GREAT PRICES!!!

Classic Hooded Design... but with a difference! Our polyester cotton blend is double lined with 2 full layers to protect the back of the head. Give yourself confidence, full vision and rugged Dadant quality with our newest Protective Bee Suits.

- Heavy-Duty Zippers
- Unobstructed Vision
- Relaxed Fit
- Elastic Waist
- 2 Large Chest Pockets
- Rugged Quality
- Easy On & Off



Closeup of embroidered logo

Improved Hood Design

Note sizes are based upon chest sizes.



**Zippered Leg Cuffs
V01180M**

Hooded Poly/Cotton Suit

\$103.⁹⁵ each

- V01180S – Small - Actual wt. 3.35 lbs.
- V01180M – Medium - Actual wt. 3.45 lbs.
- V01180L – Large - Actual wt. 3.55 lbs.
- V01180XL – X-Large - Actual wt. 3.75 lbs.
- V01180XXL – 2X-Large - Actual wt. 3.8 lbs.

VENTILATED SUIT & JACKETS



Beige Ventilated Jacket

Our partial vent suit and jacket went over so well we thought we'd bring it to you in beige. This stylish jacket will help hide those unwanted stains picked up during trips to the bee yard.
Comes in sizes Small – 4x-Large.

\$110.⁹⁵
each
any size

- V01254S** – Small - Actual wt. 2 lbs.
- V01254M** – Medium - Actual wt. 2 lbs.
- V01254L** – Large - Actual wt. 2 lbs.
- V01254XL** – X-Large - Actual wt. 2 lbs.
- V012542XL** – 2X-Large - Actual wt. 2 lbs.
- V012543XL** – 3X-Large - Actual wt. 2 lbs.
- V012544XL** – 4X-Large - Actual wt. 2 lbs.



Ventilated Suit

\$138.⁹⁵ each

- V01265S** – Small - Actual wt. 3.7 lbs.
- V01265M** – Medium - Actual wt. 3.7 lbs.
- V01265L** – Large - Actual wt. 3.7 lbs.
- V01265XL** – X-Large - Actual wt. 3.7 lbs.
- V012652XL** – 2X-Large - Actual wt. 3.7 lbs.
- V012653XL** – 3X-Large - Actual wt. 3.7 lbs.
- V012654XL** – 4X-Large - Actual wt. 3.7 lbs.

We are pleased to be the first to offer a partially ventilated suit and jacket. The ventilation areas are located along your sides running from your waistline to your wrist in the jacket. The jacket offers 4 front pockets two with Velcro and the other open for quick access. The full suit is ventilated on the outside of the legs starting at the ankles and ending at the wrist. The hood is fully ventilated on both the suit and jacket. Optimum air flow in the right places make this suit and jacket perfect for your trips into the bee yard.



Ventilated Jacket

\$110.⁹⁵ each

- V01266S** – Small - Actual wt. 2 lbs.
- V01266M** – Medium - Actual wt. 2 lbs.
- V01266L** – Large - Actual wt. 2 lbs.
- V01266XL** – X-Large - Actual wt. 2 lbs.
- V012662XL** – 2X-Large - Actual wt. 2 lbs.
- V012663XL** – 3X-Large - Actual wt. 2 lbs.
- V012664XL** – 4X-Large - Actual wt. 2 lbs.

CHILDREN'S SUITS, VEILS & GLOVES



V01265C8

Children's Ventilated Suit

Our partially ventilated adult suit was such a hit we had it copied for our children's suit as well. With protection and ventilation in the proper areas this suit is the best children's suit we have seen to date.

V01265C4 Partial Vent Suit - Childs Age 4-6, Actual wt. 1.64 lbs. ea. . . . **\$104.95**

V01265C8 Partial Vent Suit - Childs Age 8-12, Actual wt. 2.2 lbs. ea. . . . **\$104.95**



V01265C4

Children's Hat-Veil Combo with Poly/Cotton Jacket

Our jacket for 10-12 year-old children features a zippered chest pocket with elastic cuffs and waist. Easy to slip on and off for the quick trip to the bee yard with mom and dad.

V01220C Children's (10-12) Actual wt. 1.35 lbs. ea. **\$95.95**

Children's Poly/Cotton Trousers

Our children's trousers are a nice addition to our child's jacket. Featuring a front pocket with elastic waist and ankles. These trousers will give your youngster the extra protection they may sometimes need in the bee yard. Actual wt. 0.8 lbs. ea.

V01220CP Children's (10-12) **\$46.95**

Children's Hat-Veil Combo with Poly/Cotton Suit

V01170C Children's (10-12) Actual wt. 2.1 lbs. . . . **\$106.95**



Children's Jacket
V01220C

Children's Trousers
V01220CP

Jacket and Trousers Sold Separately



V01170C
Side view

Child's Two-Piece Suit Ages 4 & 6

We are pleased to offer a 4 year old and 6 year old jacket and pants combo. Trousers offer one pocket in front along with elastic around the ankles and loop to go underneath your child's feet to hold them in place. Jacket offers a single front pocket for their own pocket hive tool. Full zipper around neck area makes taking the veil off a breeze. Full zippered front. The best protection for your child's first visits to the bee yard. **Boots not included.**

V01244E Child's Two-Piece Suit Age 4, Actual wt. 1.2 lbs. ea. **\$87.95**

V01246E Child's Two-Piece Suit Age 6, Actual wt. 1.56 lbs. ea. **\$87.95**

Dadant Child's Folding Veil

This popular style veil is both cool and convenient to wear. Open mesh netting top and seamed wire netting face, side, and neck panels make for easy folding. Open mesh netting skirt for maximum protection and coolness. Available in adult size on the next page. **Helmet not included.**

V01096 Child Size, Actual wt. 0.3 lbs. **\$22.95**



V01244E

V01246E

Boots not included



Helmet Sold Separately

V01096

Child's Ventilated Leather Gloves

We are pleased to offer this top quality glove at a great price. The hand is made of top grain cowhide leather. Heavy duty rubberized gauntlet bell cuff with 100% nylon, full circular ventilation panel is firmly stitched between glove and sleeve for extra coolness on hot days. Lighter weight elbow length canvas drill sleeves with elastic band at the top provides good protection with a cooler material. Actual wt. .55 lbs.

M011382C Child's Ventilated Leather Gloves **\$29.95**



M011382C

PROTECTIVE CLOTHING

DADANT VEILS

Quality Materials — Quality Workmanship



V01093P
with
drawstring



V01100P
with zipper

Premium Dadant Folding Veil

Keeping the same design they started with many years ago this veil is sure to help keep you cool. The open mesh netting top will fit most any hat or helmet. Strong seamed wire netting face, side, and neck panels are hinged at each corner to permit easy flat folding for storing when not in use. The open mesh netting skirt allows maximum protection and coolness. Available in two styles. One with a long bottom drawstring or one with an attached zipper that is ready to be sewn into your bee suit. Will fit most hats and helmets. Helmet not included.

- V01093P** Premium Folding Veil with Bottom Drawstring —
Adult Size, Actual wt. 0.55 lbs. **\$31.95**
- V01100P** Premium Folding Veil with Zipper —
Adult Size, Actual wt. 0.55 lbs. **\$29.95**

Dadant Folding Veil

This popular style veil is both cool and convenient to wear. Open mesh netting top and seamed wire netting face, side, and neck panels make for easy folding. Open mesh netting skirt for maximum protection and coolness. Available in adult with drawstring, child's with drawstring, and with attached zipper that allow this to be sewn onto your favorite suit. **Helmet not included.** V01093 Actual wt. 0.4 lbs., V01100 Actual wt. 0.36 lbs.
V01093 Folding Veil w/Bottom Drawstring—Adult Size . . . **\$22.95**
V01100 Folding Veil w/Bottom Zipper—Adult Size **\$24.75**

Dadant Alexander Veil *Best Value*

The Alexander Veil has a durable white cloth top that forms the hat. Full-vision, round one-piece screen-wire veil — no helmet needed. Inner elastic headband holds veil in position so top does not touch the head. Cloth top extends down back of veil to form sunshade for the neck. Long tie-down drawstring.

V01090 Alexander Veil, Actual wt. 0.35 lbs. ea. **\$24.95**

Dadant Excelsior Veil

A wire veil of one-piece round construction allows clear view in all directions. Double-seamed, open mesh netting, top and bottom. Elastic top. Bottom drawstring. Cool. Fits our helmet's and most hats. **Helmet not included.**

V01094 Excelsior Veil, Actual wt. 0.25 lbs. **\$21.95**

Dadant Tulle Veil

Tulle Veil uses clear-vision fabric that is really cool. Elastic cord at bottom and top so veil will fit any hat. This veil is the lightest weight and easiest to carry of all. Fold and put it in your pocket. Great for any outdoor activity! Keeps away mosquitos, black flies and gnats. Fits our helmet and most hats. **Helmet not included. Works best with ventilated or plastic sun helmets.**

V01092 Tulle Veil, Actual wt. 0.2 lbs. **\$17.50**

Pullover Veil

This pullover veil is perfect for quick inspections when donning full protective gear isn't warranted. Great for times you are just wanting to peek in the hive or as a spare veil for interested visitors.

V01103 Pullover Veil, Actual wt. 0.5 lbs. **\$57.95**

Hat Veil Pullover Combo

A new slip-on hat/veil combination features the same polyscreen material used in our polyscreen folding veil. Ideal for a quick inspection — simply slip it on and go. Wide brim hat holds veil out from the face.

V01108 Hat Veil Pullover Combo, Actual wt. 0.65 lbs. ea. . . . **\$46.95**

(All veils and helmets sold separately)



Folding Veil



Alexander Veil



Excelsior Veil



Tulle Veil



Pullover Veil



Hat Veil Pullover Combo

BEEKEEPING HATS AND GLOVES

Dadant Plastic Sun Helmet

Dadant Plastic Sun Helmet — We designed it with you in mind. Molded of gleaming white plastic, the full wide brim holds the veil away from your face. Side louvers allow maximum circulation of air around the head. Adjustable inner headband fits all head sizes and holds the helmet away from the head for even more air circulation. Ideal combination with any of our veils or wear it around the yard and garden for cool protection from the sun. Actual wt. 0.4 lbs.

*Our plastic sun helmet was designed for the prevention of the Apis mellifera honey bee from entering. **Caution:** other smaller breeds may be able to enter.*

M01049 or M01049S
 1-29 \$16.95
 30-49 \$15.50
 50-199 \$14.00
 200-499 CALL
 500 & Up CALL

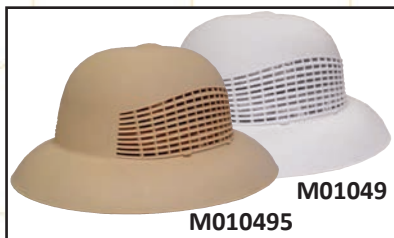

Ventilated Sun Helmet

Ventilated Sun Helmet — Woven open mesh material is strong and lightweight. Allows maximum circulation of air. Adjustable headband. Water-resistant. Available in either tan or white.

M01087 Tan, Actual wt. 0.4 lbs. \$30.95
M01087W White, Actual wt. 0.4 lbs. \$30.95

Sweat Band

M01088 Sweat Band
 Actual wt. 0.05 lbs. ea. . . \$5.95

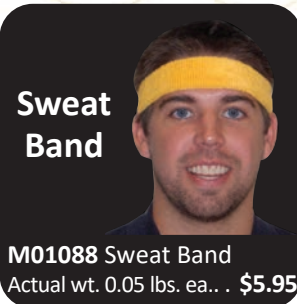

Heavy Duty Ventilated Leather Gloves with Velcro strap

Many have come to us over the years asking for a larger opening to our gloves with better elastic. We took it one step further and have put a Velcro strap on our heavy duty ventilated gloves. Available in larger sizes only.

M011350X — X-Large - Actual wt. 0.9 lbs. **\$34.⁹⁵**
M0113502X — 2X-Large - Actual wt. 0.9 lbs. **each**
M0113503X — 3X-Large - Actual wt. 0.9 lbs. **any size**



Ventilated Gloves

Our new ventilated gloves are for those working hot hives with hot hands. Our heavy duty ventilated leather gloves have added protection at the knuckles and finger tips with ventilation on the backside of your hands for optimum air flow. Give them a try today and see how cool these gloves really are.

M01179S — Small - Actual wt. 0.5 lbs. **\$30.⁹⁵**
M01179M — Medium - Actual wt. 0.5 lbs. **each**
M01179L — Large - Actual wt. 0.5 lbs. **any size**
M01179X — X-Large - Actual wt. 0.5 lbs.
M011792X — 2X-Large - Actual wt. 0.5 lbs.



Ventilated Leather Gloves

We are pleased to offer this top quality glove at a great price. The hand is made of top grain cowhide leather. Heavy duty rubberized gauntlet bell cuff with 100% nylon, full circular ventilation panel is firmly stitched between glove and sleeve for extra coolness on hot days. Lighter weight elbow length canvas drill sleeves with elastic band at the top provides good protection with a cooler material. Ship. wt. 1 lb. State size by item number.

M011382 — Small - Actual wt. 0.65 lbs. **\$30.⁹⁵**
M011372 — Medium - Actual wt. 0.75 lbs. **each**
M011362 — Large - Actual wt. 0.7 lbs. **any size**
M011352 — X-Large - Actual wt. 0.8 lbs.
M011342XX — 2X-Large - Actual wt. 0.8 lbs.



BEEKEEPING GLOVES



Lighter Weight Ventilated Leather Gloves

A lighter weight version of our glove. Basically the same construction and same quality features. This glove incorporates a lighter weight leather for those not needing the day-to-day durability of our premium, more expensive, glove. Ship wt. 1 lb. State size by item number.

- M011381 – Small - Actual wt. 0.37 lbs.
- M011371 – Medium - Actual wt. 0.66 lbs.
- M011361 – Large - Actual wt. 0.8 lbs.
- M011351 – X-Large - Actual wt. 0.4 lbs.
- M011341XX – 2X-Large - Actual wt. 0.8 lbs.

\$25.⁹⁵
each
any size



New Goatskin Gloves

These mid weight goat skin gloves are perfect for your day in the apiary. Cotton gauntlet fits most half way between the wrist and elbow. Perfect for those with large forearms. Ship wt. 1 lb.

- M01096 – Small - Actual wt. 0.3 lbs.
- M01097 – Medium - Actual wt. 0.3 lbs.
- M01098 – Large - Actual wt. 0.3 lbs.
- M01099 – X-Large - Actual wt. 0.3 lbs.
- M01100 – 2X-Large - Actual wt. 0.3 lbs.

\$31.⁹⁵
each
any size



Canvas Gloves

Heavy canvas gloves specially treated to make them even more sting-resistant. The full-elbow length sleeve has an elastic top. Fits snugly around the arm below the elbow. Not washable. Ship. wt. 10 ozs. State size by item number.

- M01080 – Small - Actual wt. 0.37 lbs.
- M01079 – Medium - Actual wt. 0.4 lbs.
- M01078 – Large - Actual wt. 0.47 lbs.

\$17.⁹⁵
each
any size



Rubber Gloves

This new style of rubber gloves caught our eye one day when preparing to use mite treatments on our hives. Heavy duty latex that is easy to wash. Great glove for the honey house and to wear while applying treatments to your hives. Ship wt. 1 lb.

- M01090 – Medium - Actual wt. 0.5 lbs.
- M01091 – Large - Actual wt. 0.5 lbs.
- M01092 – X-Large - Actual wt. 0.5 lbs.

\$16.⁵⁰
each
any size

Yard Apron

Great for working in the honey house or the kitchen. Divided legs each have easy-to-clasp fasteners. Easy walking — Comfortable sitting. Actual wt. 0.55 lbs. ea.

*Ideal in the
Honey House*

- Poly-Cotton Blend
- Divided Leg Style

M01077
Yard Apron

- 1-11 \$28.95
- 12 & Up \$27.95



M01086

Plastic-Coated Canvas Glove

Actual wt. 0.47 lbs.

- M01086 — Small \$16.95

REMOVING BEES FROM SUPERS FILLED WITH HONEY

Using Bee Escapes

Bee Escapes are one-way doors which let the bees leave the supers but not return. The escape is placed beneath the supers of honey to be removed. (When removing more than one super of honey from an individual hive, we recommend placing an empty shallow super under the escape board to allow more space.) Supers are usually free of bees within 2 - 24 hours and no chemicals are used.



M00940

Assembled

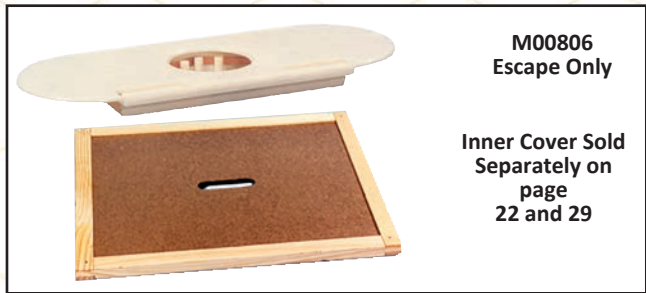

M00806
Escape Only

Inner Cover Sold Separately on page 22 and 29

Bee Escape Board

The Triangle escape board works like a bee escape except the bees are able to leave the super much quicker. Face the triangle covered with hardware cloth towards the bottom of the hive. Bees will exit through escapes on the side of the triangle and can't figure out how to get back in.

- M00940 Bee Escape Board, Actual wt. 2.6 lbs.
10-frame. \$20.95
- M009408 Bee Escape Board, Actual wt. 2.14 lbs.
8-frame. \$20.95

Standard Bee Escape And Inner Cover

This bee escape is placed in the center opening of an inner cover (B15201) described on page 22 and 29. Actual wt. 0.02 lbs.

- M00806 Standard Bee Escape
1-11 \$5.25
- 12+ ea. \$4.25

M01993

Hive not included

top view of motor

Attach motor to part below

Fume Board

Hole in Fume Board

circulating air

hole plug

Underneath foam liner

New and Improved!

Turbo Fume Board — 10-Frame

Dadant, along with hobby beekeeper/attorney Reeves Jones from Mississippi, have designed one of the first battery-powered Fume Boards. Insert batteries, spray your bee repellent on the pad & place on the hive. Turn on the motor & you'll be surprised how fast the bees leave the super. Save yourself time with this new unit. Not to be used with Butyric Acid. Board & blower can be purchased separately from complete unit.

Blower Requires 4 AA batteries, not included.

- M01993 Turbo Fume Board Complete, Actual wt. 2.4 lbs. \$29.95
- M01994 Battery Blower only for Fume Board, Actual wt. 0.5 lbs. \$11.95
- M01996 Fume Board only with cap, Actual wt. 1.9 lbs. \$19.95
- M01999 Replacement rivets (8) \$3.75
- M01410 Replacement liner \$2.50

REMOVING BEES FROM SUPERS FILLED WITH HONEY

Repellent Method



Black Fume Pad

We offer two sizes of fume pads for your needs. This 10-Frame black topped fume pad will help capture the sun's rays to speed up the process of moving honeybees out of your supers full of honey. Apply fumigant on underside of pad.

- M60070** 10-frame Black Fume Pad,
Actual wt. 1.65 lbs. **\$20.75**
- M600708** 8-frame Black Fume Pad
Actual wt. 2.6 lbs..... **\$20.75**



Honey-B-Gone

Honey-B-Gone is a new, easy to use, natural oil honey bee repellent. Spray on fume boards and place on top of honey supers. Watch the bees flee.

- M00136** Honey-B-Gone, 16 fluid ozs.,
Actual wt. 1.1 lbs..... **\$38.95**
- M00136G** Honey-B-Gone, 1 gallon,
Actual wt. 8.85 lbs. **\$189.55**

Bee Go

Bee Go — Approved chemical that quickly chases bees from honey supers on hot or cold days, early morning to late evening. Use fume pad **M60070** and **M60078**. 1 and 5 gallon cans ship *Freight Only* — Hazardous price on shipping will apply — call for quote. Additional charges may apply. Pint size is for pick-up only — cannot be shipped by ground. (see *Honey-B-Gone* or *Bee Dun* which can be shipped).

- M00130** Bee Go, 1 Pint. **\$26.95**
Case of 30..... **\$25.95**
- M00131** Bee Go, 1 Gallon..... **\$134.95**
Case of 5..... **\$131.95**
- M00132** Bee Go, 5 Gallons..... **\$432.95**

Hive not included

Bee Dun

Bee Dun is the beekeepers friend at harvest time. Made out of a pleasant smelling combination of natural oils, this is really the way to remove bees from your honey supers. 8 oz. bottle.
Actual wt. 0.55 lbs.

- M00135** Bee Dun, 8 fluid ozs.
..... **\$21.95**

M00135



M00132

M00130

M00131

UNCAPPING PRODUCTS

Uncapping Fork

Our new uncapping fork/scrapper is a great tool to have in the honey house. These sharp needles will penetrate your wax capping providing a clean cut every time. Actual wt. 0.33 lbs.

M01767 Uncapping Fork \$24.95



M01767

Uncapping Plane

Electric Uncapping Plane — Perfect tool for small or large operations. UCP has an adjustable heated copper cutting blade for depth of cut. The heating element is long lasting and replaceable. On/off switch built into cord. The large comfortable rock maple handle is comfortable to use. Just pull the UCP across the combs and feel the difference. UCP 110V, right hand. Actual wt. 2.6 lbs.

M00335 Uncapping Plane \$209.95



M00335

Uncapping Roller

This 4" uncapping roller will help you uncap faster than ever before. Made of food-grade plastic. Actual wt. 0.59 lbs.

M00334 Uncapping Roller \$25.75

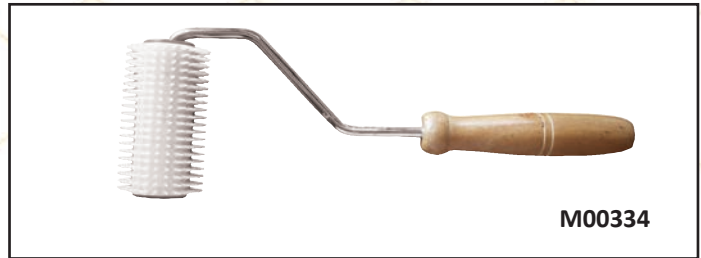

M00334

Cappings Scratcher

The **Cappings Scratcher** is the only "uncapping tool" used by many hobby beekeepers. An excellent hand tool for opening the cells to let the honey out. 20 sharp needles molded into high strength plastic. A must in every honey house. Colors may vary. Actual wt. 0.5 lbs.

M00752 Cappings Scratcher \$11.50
12+ \$10.50
Actual wt. 6 lbs. per 12 ea.



M00752

Stainless Steel Cappings Scratcher

High quality one piece stainless steel cappings scratcher with blade to remove burr comb from top bars. Molded rubber handle. Actual wt. 0.35 lbs.

M01752 Stainless Steel Cappings Scratcher \$31.50



M01752

Serrated Comb Honey Knife

Serrated Comb Honey Knife — the best comb cutting knife we have found. This extremely sharp and serrated knife makes slicing through comb a breeze. Total knife length 8.5" (blade length 4") Actual wt. 0.1 lbs.

M00336 Serrated Comb Honey Knife \$16.95



M00336

Serrated Uncapping Knife

The best "cold" uncapping knives we have found, the double sided serrated knife cuts through the capping very effectively. Actual wt. 0.5 lbs.

A high quality tool from Portugal.

M00338 Serrated Uncapping Knife \$39.95



M00338

UNCAPPING PRODUCTS



Electric Uncapping Knife with Control Unit

Blade temperature is controlled by using the knob on the control box. Set to temperature of your liking and uncap. High quality blades that are 10" long and 2" wide. Actual wt. 2.1 lbs.

M00343 Electric Uncapping Knife \$208.95

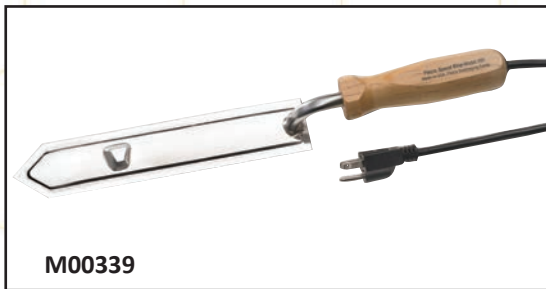

Speed King Electric Knife

Blade temperature is controlled by built-in thermostat. 120 volt operation. Wood handles are cool on your hands. High quality blades are 10" long and 2" wide. Guaranteed by manufacturer for 1 year with all warranties handled by manufacturer.

Actual wt. 1.4 lbs.

M00339 Speed King Electric Knife \$145.95



Combcapper

The combcapper fits standard 5 gallon pails and will hold all size frames, shallow and deep. Uncap directly into your 5 gallon pail. Easy clean up. Dishwasher safe. **Made in the USA.** Actual wt. 1.1 lbs.

M01366 Combcapper \$38.95



Comb Honey Cutter

This is a perfect tool for professional and backyard beekeepers who produce cut combs. With this tool, you no longer have to struggle to cut through cut combs using old-style cold cutters and sticky surfaces. The heated cutting blade makes cutting cut combs a breeze. It cuts precisely the exact size of the cut comb every time. It has a separate temperature controller that allows users to increase or decrease the temperature based on their experience in cutting combs. 4 X 4-inch cutting blade. Cut pieces fit perfectly in standard-cut comb plastic containers.

M00344 Comb Honey Cutter \$215.00

Pierce Deluxe Uncapping Tub

The bottom tank is equipped with a heavy-duty injection-molded 1.5" honey gate, featuring a scissor action for clean cut-off against an O-ring. This multipurpose tub kit includes a wooden crossbar with a stainless Steel frame-holder spike and J-bolts as well as a bottom tank that can be used either as a honey storage tank or as a bottling tank. It can hold 5 gallons of honey, and its lid can be used as a hive tray during honey harvesting time as well as during hive transportation. This tub has been specially designed and produced as an uncapping tub — it is not just another modified, off-the-shelf, non-food-grade plastic bin.

This tub's large capacity holds hours' worth of wax capping. Its grid prevents the capping from falling into the bottom tank, which collects honey drained from the wax capping. When in use, the two stacked tanks have a combined height of 18". When stacked for storage, the height reduces to 9".

M00345 Pierce Deluxe Uncapping tub
Actual wt. 22 lbs. ea.* \$215.95

*See page 136

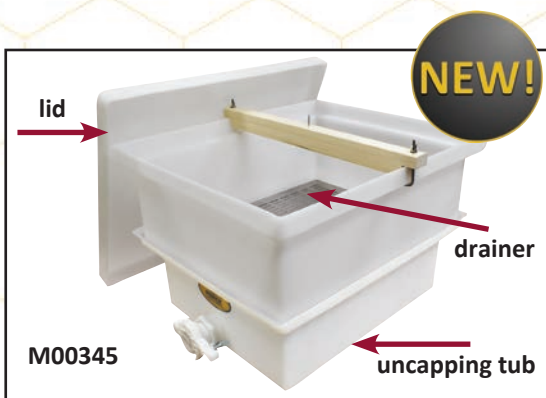

Tub Filter

Fits with Pierce Deluxe Uncapping Tub This item is made of food-grade material, meaning you don't have to worry about any toxins altering quality of your honey. 600 micron food-grade uncapping tub filter.

M00346 Tub Filter, Actual wt. 22 lbs. ea.* \$24.80



UNCAPPING / FILTERING SUPPLIES



M01365

Bucket Filter Stand Patent Pending

Sick of not being able to top off your 5 gallon pails of honey when using the bucket strainers? Try our bucket filter stand and fill those pails to the top. Made of quality stainless steel. Actual wt. 01.55 lbs. ea. *Patent Pending.*

M01365 Bucket Filter Stand \$29.95



M01312

Stainless Steel Double Sieve

Adjustable to fit containers up to 14" diameter. A great way to strain honey directly from your extractor. Remove wax particles and other foreign material, anywhere you need a strainer. Coarse strainer is 1000-micron mesh and the fine strainer is a 500-micron mesh. Actual wt. 1.19 lbs. ea.

M01312 Stainless Steel Double Sieve \$37.95



Strainer Materials

Use with strainer screens, plastic uncapping tank or by itself. 100% cotton cheesecloth.
3 sq. yd. package
Actual wt. 0.35 lbs. ea.

M00493 Strainer Materials . . . \$12.95

M00493



M00824

Wax Pan

- Easy Wax Release
- 35 Pound Capacity
- Compression Molded Fiberglass
- Reinforced Polyester
- High Strength for Years of Service
- 12" x 15" x 20"

Actual wt. 5.18 lbs. ea

M00824 Wax Pan \$48.95

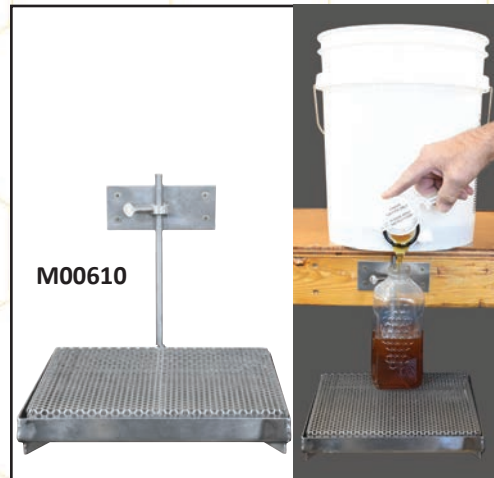

M00610

Adjustable Bottle Filler Stand

This stainless steel bottle filling stand easily connects to your workstation. With the turn of a screw your fill level is adjusted to the correct height, making the filling of your containers a breeze.

M00610 Bottle Filler Stand, Actual wt. 4 lbs.
..... \$84.90

UNCAPPING / FILTERING SUPPLIES



Bucket Bench

The Bucket bench is a convenient tool to drain your 5 gallon pails of honey to the last drop. Collapsible and easy to clean this is a must have tool for the honey house.

M01380 Bucket Bench, Actual wt. 0.25 lbs. ea. **\$25.95**



Bottling Bucket*

The Dadant designed 1½" scissors gate installed in a heavy gauge white plastic pail makes a great unit to fill honey bottles. The gate is adjustable and cuts honey flow off cleanly. Bucket is re-inforced where bail attaches. Comes with lid.

M00218 Bottling Bucket, Actual wt. 3 lbs. ea. **\$37.95**

BOTTLING BUCKET KIT*

Ideal for filtering large, medium and small particles from honey. Comes complete with three reusable, washable filters. 600 micron for coarse filtering, 400 micron for medium filtering and 200 micron for fine filtering. These filters are custom designed to fit securely on the 5 Gallon Honey Bucket. Filters are 11¼" in diameter.

An excellent and inexpensive filter that will make your honey sparkle.

Kit Includes the following:

- 200 Micron Fine Filter
- 400 Micron Medium Filter
- 600 Micron Coarse Filter
- 5 Gallon Pail Honey Bucket (Gate Included)
- Lid

M01354 Bucket Kit

Actual wt. 4.8 lbs.

\$56.95

Filters can be purchased separately



Bucket sold separately

Honey Tight™ Lid

Transform your bottling bucket or 5 gallon honey storage bucket into an easy opening, airtight, pest proof container with the new Dadant Honey Tight Lid. When attached to the Dadant 5 gallon white plastic pail (M00212 page 104) the screw top resealable Honey Tight Lid protects your honey, while allowing easy access for pouring or bottling. No more prying open regular old fashioned lids. Now the lid spins off and on with just a twist.

M00214 Honey Tight Lid
Actual wt. 1 lb. ea **\$12.95**

Filters are 11¼" in diameter.



- M01352** 600 Micron Coarse,
Actual wt. 0.5 lbs. ea **\$9.75**
- M01351** 400 Micron Medium,
Actual wt. 0.5 lbs. ea **\$9.75**
- M01350** 200 Micron Fine,
Actual wt. 0.5 lbs. ea **\$9.75**

***Use of Bottling Bucket is intended for bottling only — long term storage is not recommended.**

HONEY HEATING AND MOVING EQUIPMENT AND IMPORTED EXTRACTOR

Immersion Heaters

Single Phase, High Quality Heaters

Immersion Heaters Single phase. Thermostatically controlled. Fully encased sensing tube. Highest quality materials. Not for direct contact with honey. Long life.

- M00537** 120 volt, 1700 watt heater, 1" male Pipe Thread, Actual wt. 3.95 lbs. . . . \$265.00
M00361 240 volt, 4500 watt heater, 2" male Pipe Thread, Actual wt. 3.95 lbs. . . . \$335.20

Maximum temperature on all models of immersion heaters is 250°F.

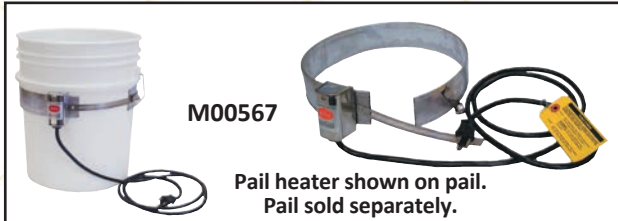

M00567

Pail heater shown on pail.
Pail sold separately.

Band Pail Heater

Flexible Strip Heater for 5 Gallon Pails

It will take approximately 6 hrs to bring a 5 gallon pail of honey from 70° to 125°. It is recommended that you stir the honey periodically while heating to decrease heat time.

*Pail Heater for 5 gallon plastic pails.

- M00567** Actual wt. 3.34 lbs. ea. \$149.95



M00556 and M00557

plug for M00556

plug for M00557

Band Drum Heaters

Flexible Strip Heaters for 55 Gallon Drums

*Drum Heater—120 volt, 1750 watt, for 55 gallon drums.

- M00556** Actual wt. 12.82 lbs. ea. \$499.95

*Drum Heater—240 volt, 3000 watt, for 55 gallon drums.

- M00557** Actual wt. 12.5 lbs. ea. \$499.95

*Special receptacle required for M00556 and M00557.
Contact a qualified electrician. See plugs above.

Bee Blanket

The Bee Blanket covers a uniform heat zone giving consistent liquefying of your honey, time and time again. Cinch straps tighten the bee blanket to your pail for snug fit. 120 Volt, 120 Watts

- M00571** Bee Blanket
Actual wt. 3 lbs. \$158.95



M00571

Super Cart

We are pleased to offer another item that will come in very handy in the honey house. Our super cart comes with casters so you are able to roll it around the honey house with ease. Place up to 5 deep boxes on the cart and roll it in to extract. Handy in the Honey House



M00324

Assembled

- M00324** Super Cart, Actual wt. 9.05 lbs. \$49.95

Drum Handling Truck

Heavy-duty Drum Handling Truck takes much of the heavy work out of handling drums full of honey. Position the toes of the truck against the drum, engage movable sliding hook over edge of drum, pull back on handles and the drum tilts, allowing truck toes to slide under and engage bottom of barrel. Load is secure and ready to go. 61" high, 23½" wide. 10" wheels.

Ships Freight Only.



M00311

- Drum Handling Truck,
Actual wt.
67.5 lbs. ea.*
\$619.95

* See page 136



M00311

Move 55 Gallon Drums Safely and Easily
Heavy Duty Construction
Drum Hook Holds Top Edge of Drum

Closed Cell Foam Gasket

Gasket for sealing the lids onto 55 gallon open top barrels. Actual wt. 0.15 ozs.

- M01530** \$1.24 ea.
100+ \$1.15 ea.

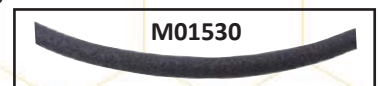

M01530

Rubber Gasket

Rubber gaskets for sealing the lids onto 55 gallon open top barrels. Actual wt. 0.15 lbs.

- M00755** 1-99. \$1.15 ea.
100+ \$1.10 ea.



M00755

Economy Stainless Steel Extractor

This import extractor is a cheaper alternative to our US made Dadant extractors. It is the same unit that most other supply houses here in the states sell. It won't last a lifetime, but will get you started in an economical way. Two-frame basket extractor comes complete with stainless tank and gate valve. No returns after use. Actual wt. 21.5 lbs.

- M00385** \$144.15



M00385

Imported

Inside view

Dadant 36" CAPPINGS TANK AND OPTIONAL EQUIPMENT

36" Cappings Tank



Tank is:
36" Long
18" Wide
14" Deep

M00370



M00372

Liquifier Grid & Heater
Liquify your honey quickly, evenly... without hassles!

Dadant Liquifier Grid & Heater — Converts cappings tank into a 3-60# container liquifier. 1700 watt, 120 volt immersion heater screws into tank fitting and goes underneath the stainless steel 2¾" high container supporting grids. Fits 1983 and newer model Cappings Tanks. Grid and heater only, Cappings Tank sold separately on left. **Ships Freight Only**

✗ M00372 Grid & Heater Only,
Actual wt. 19 lbs.* \$399.95
* See page 136

36" Cappings Tank *Convenient wheels make moving easy*

Dadant 36" Cappings Tank — All-welded heavy type 304, 16 Gauge Stainless Steel tank. Heavy stainless legs. Casters with brakes enable you to roll uncapped frames to the extractor for loading or lock it securely in place. Holds 23 frames. Over-all height with casters - 32". The perfect start for any honey house. **Ships Freight Only**

✗ M00370 Cappings Tank,
Actual wt. 51.75 lbs. ea.* \$814.95
* See page 136



M00373

Cappings Tank Lid — Another Versatile System —

✗ M00373 Cappings Tank Lid
Actual wt. 13.9 lbs. ea.* \$299.95
* See page 136

Cappings Baskets *Excellent Cappings Drainage*

Dadant Cappings Baskets — Designed for use in the cappings tank. 17½" x 17" Type 304, 22-gauge stainless steel construction. Uncap directly into the baskets. Perforated aluminum bottom allows good cappings drainage. Sturdy construction allows basket full of drained cappings to be lifted from the tank. Pair.

✗ M00371 Cappings Baskets (per pair)
Actual wt. 13.36 lbs. \$249.95

**Tank Not Included
Capping Baskets Only**



M00371

WAX MELTERS



LET THE SUN DO THE MELTING!

M00501

Not Assembled

Solar Wax Melter

Solar Wax Melter — The perfect answer for melting up those burr combs and small amounts of wax. Melter is 19" x 24". Works best when painted black. Comes unassembled. Inexpensive polyethylene film for top to be purchased locally.

M00501 Solar Wax Melter, Actual wt. 20.53 lbs. ea **\$174.95**

Deluxe Solar Powered Wax Melter

The **ALL NEW Deluxe Solar Powered Wax Melter** is an affordable, high performance melter that uses the power of the sun to melt valuable wax with no cost to operate. It is capable of reaching and maintaining temperatures as much as 50°F above melting temperature without harmful UV ray exposure. Warm-up takes about 30 minutes and in most locations, melting can be achieved in 6-7 hours on a sunny day. Even on partly cloudy days, extended periods of melting are possible.

The Deluxe Solar Powered Wax Melter is constructed of 7-11 layer hardwood plywood which is painted black in the melting areas and polycrylic finish sealed on the exterior. It is assembled with waterproof, high strength urethane adhesive and power driven nails. Solar transfer is accomplished via multi-wall structured polycarbonate, 10mm thick sheet surrounded by a sealed wooden frame. A sliding, captive front door allows for exchanging of catch pans during the melting cycle without having to raise the main cover.

The melting and collecting areas will accommodate your pans, screen and filter cloths up to 18" x 12" x 5½" for the melting pan and up to 11" x 5" x 3" for the collecting pan. Use of aluminum pans typically sold in grocery stores and hardware outlets is recommended. Loading is easy since the cover can be completely removed providing total access to the melting area. The Deluxe Solar Powered Wax Melter can be shipped anywhere in the U.S. or Canada.



Assembled

M00505

M00505 Deluxe Solar Powered Wax Melter, Actual wt. 28.28 lbs. ea..... **\$289.95**

Dadant's FINE FAMILY OF MELTERS



Dadant's Water Jacketed Mini Melter
Uncap directly into the unit
Draw beautiful wax from one outlet
Excellent quality honey from another outlet

Wax Melting Grid 1800 watt — 120 volt
1700 watt — 120 volt Immersion Heater for Water
Both Heaters Are Thermostatically Controlled

The water jacket speeds the wax/honey separation process and allows precise control of honey temperature. Cappings from 300 lbs. of honey per hour have been processed with the Dadant Mini Melter. Operating conditions vary, therefore, production rates will vary. Will handle most hand uncapping operations and some smaller volume power uncappers. Comes complete as shown. Please call or write for complete information sheets. Patented.

✘ **M005491** Water Jacketed Mini Melter, with Type 304, 16-gauge stainless steel, Actual wt. 63.15 lbs. ea.* **\$1,899.00**

* See page 136

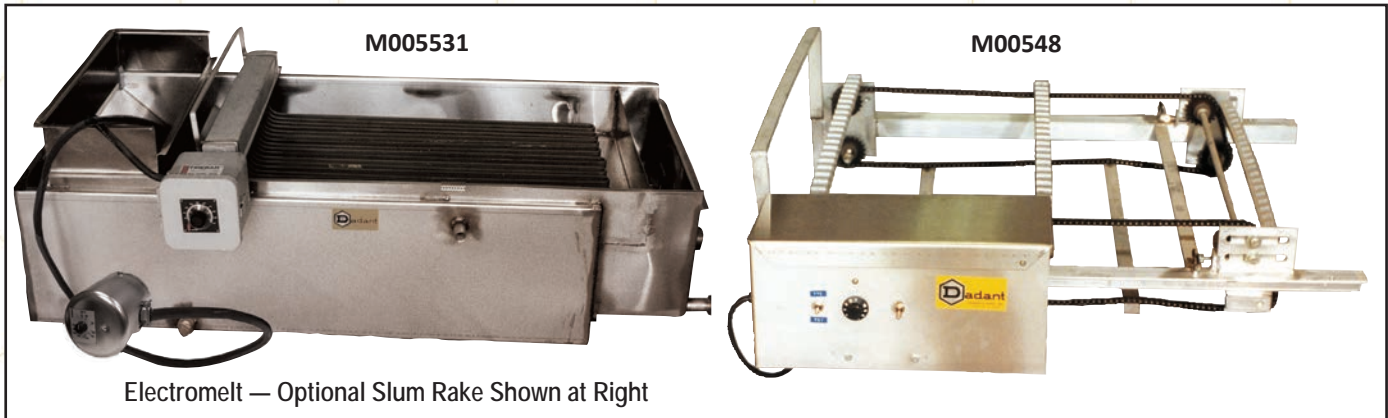

Electromelt — Optional Slum Rake Shown at Right

HONEY HARVESTING

Dadant's Water Jacketed Electromelt



A Proven Process

Separate Wax and Honey in 1 Step While You Uncap

Eliminates Spinners

Saves Time and Money

Optional Slum Rake System

Speeds Processing—Saves Time

Features and Benefits of the Electromelt

- 6900 watt, 240 volt melting grid
- Stainless steel flat heating grid
- Stainless steel tank, 16 gauge
- Stainless steel water jacket
- Works with all uncappers
- Fast start up
- No steam required
- 3 year warranty on electric melting grid



The Electromelt has been proven by commercial beekeepers using all types of uncappers. The unit was designed for and works most efficiently with cappings from uncappers other than the chain flail type. Producers report processing cappings from over two drums of honey per hour when using the rake system with the Electromelt. At the day's end, all honey and wax are processed — no extra hours, no additional jobs to do. Quality wax is in pans, and premium honey is in storage, operating costs are low, as energy losses are minimal. When paying 8 cents per kilowatt hour, operating costs are less than 75 cents per hour. Both the melting grid and water jacket heater are thermostatically controlled for precise control. Call or write for more information. **Ships Freight Only**

✘ **M005531** Electromelt with Water Jacket, Type 304, 16 gauge SS, Actual wt. 350 lbs. ea.* **\$6,399.95**

* See page 136

✘ **M00548** Aluminum Rake System, Optional, Actual wt. 70 lbs. ea. **\$2,479.00**

Dadant MANUFACTURED HONEY EXTRACTORS



**HAND CRANK FOR
HAND EXTRACTOR**



M00406



Stainless steel wire basket



**HAND CRANK FOR
HAND EXTRACTOR**



**Stainless
steel wire
basket
Shown with
frames**

**Frames not
included**

M00407



M00408



2-Frame Extractor

2-Frame Extractor — Stainless steel hand powered. Capacity: 2 frames (9½” deep maximum) per load. SS extracting basket and SS top assembly. Piano-style continuously hinged lid. Easily converts to 175 lb. storage container. (Frames must be removed and turned to extract both sides). 1½” plastic honey gate included.

Tank: 24 gauge,
Type: 304 SS,
Dimensions: 14” dia. x 23¼” tall,
All MIG welded construction.
Actual wt. 26 lbs.

M00406 2-Frame Extractor \$499.95

Food Approved Grease

Food Approved Lubricant for extractors, honey house equipment and other applications where it is important to avoid contamination of food products with ordinary lubricants. On the hand extractors use this to lubricate the crank handles. Also used on above hand and power units to lubricate the bottom bushing. Handy 12 oz. cartridge. Use **M009574** for 2-, 4-, and 6-frame extractors. Use **M0095712** for 12-frame and up extractors.



M0095712

**12 oz. Cartridge -
Haynes Lubri-Film**
Actual wt. 0.85 lbs.

M0095712 1-11, ea. . \$12.95
12+ \$12.50



M009574

4 oz. Tube - Haynes Lubri-Film
Actual wt. 0.3 lbs.

M009574 \$6.95

4-Frame Extractors

4-Frame Extractors — Top quality tangential extractors. Extract four 9½” frames or shallow frames per load. All welded food grade stainless steel tank houses the stainless basket. Frames must be turned to extract both sides. Turn shallow frames within basket; deep frames must be lifted out for reversal. Hand models are gear driven by quiet, durable nylon gears. Power models employ a direct drive motor with an electronic speed control which is manually adjusted. 120 volt operation. All internal components slip out easily to convert into a 300 lb. storage unit. Comes complete with 1½” gate. Tank: 24-gauge, Type 304 SS, 18” dia. x 24” tall.

✘ **M00407 4-Frame Hand,**
Actual wt. 34.46 lbs. ea.* **\$629.95**
* See page 136

✘ **M00408 4-Frame Power,**
Actual wt. 50 lbs. ea.* **\$1,049.95**
* See page 136

Dadant MANUFACTURED HONEY EXTRACTORS

6-frame Extractors

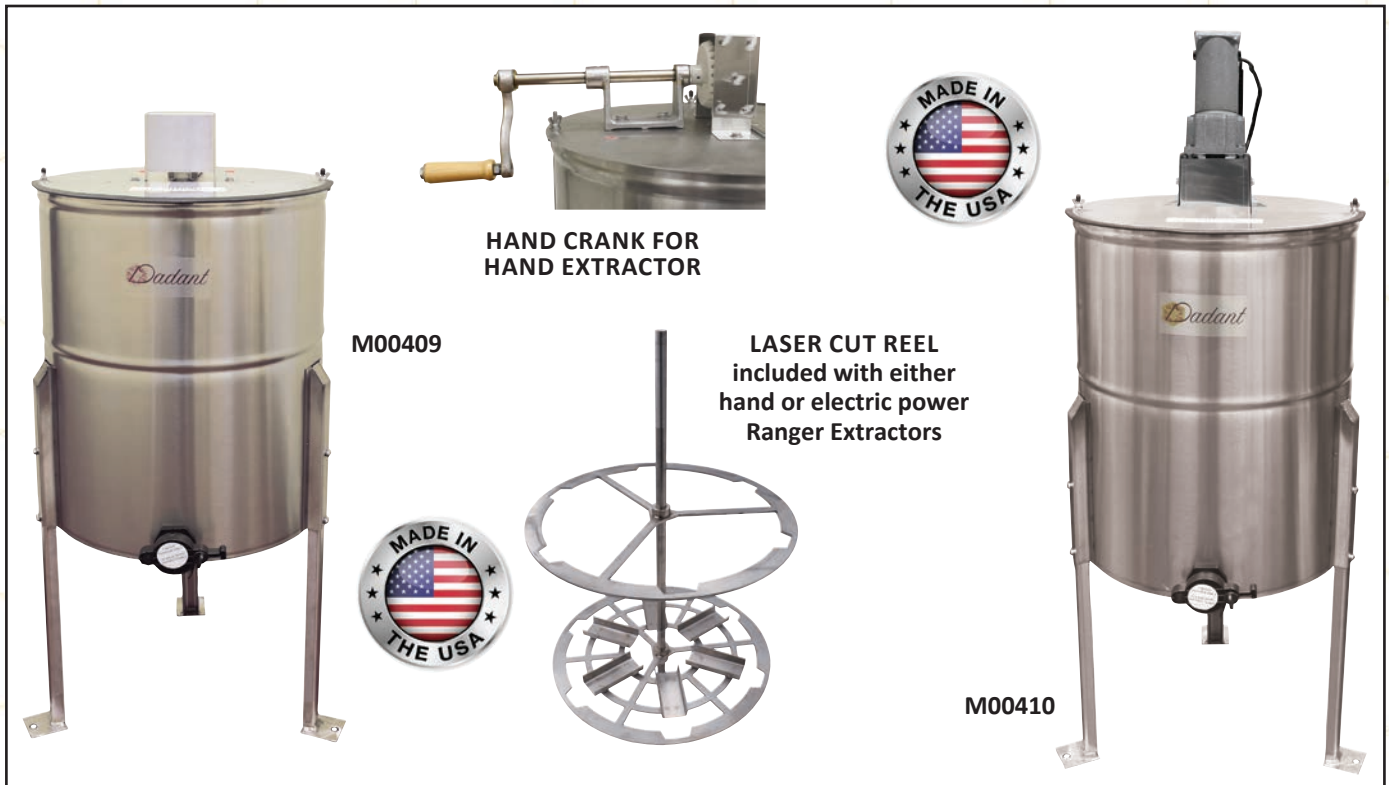

M00409

HAND CRANK FOR
HAND EXTRACTOR

LASER CUT REEL
included with either
hand or electric power
Ranger Extractors

M00410

6-Frame Extractors — Designed for beekeepers using primarily 6¼" or shallow frames. Extract six 6¼" or shallow frames radially or 3 deep (9½") frames tangentially by using optional baskets (sold separately). Electric power features direct drive electric motor with manually operated electronic speed control. All welded 18" dia. 24" tall, 24-gauge, Type 304 stainless tank. 1½" plastic honey gate standard. For smooth operation of extractor see food approved grease on page 85.

- ✘ M00409 6-Frame Extractor,
Actual wt. 38.42 lbs.* \$799.95
- ✘ M00410 6-Frame Power Extractor,
Actual wt. 55 lbs. ea. \$1,295.00
* See page 136
- ✘ M00409B Optional Baskets, for Deep Frames,
Actual wt. 5.15 lbs. \$149.95

Cappings Spinner

Capping Spinners — Great for the serious but smaller operations. Separate your honey and wax cappings with ease! The results are more honey to sell and dry, light fluffy wax cappings ready for melting into bricks. This machine is a must for beekeepers operating 100 hives or less. The 20-gauge stainless steel tank is 20" in diameter and 32" high. The bottom is die formed, and conical for ease of side draining. The removable cappings basket is constructed from 18-gauge perforated stainless steel and laser cut to perfection. Complete with legs, this machine ships at a weight of 150 lbs. in a heavy duty carton. **Ships Freight Only**

- ✘ M00599 Junior Capping Spinner,
Actual wt. 113 lbs. ea. \$2,399.00



M00599

EXTRACTING KITS



2-frame Extractor Kit

2-Frame Extractor Kit — The 2-frame Extracting kit is the perfect extracting set up for the beginning beekeeper. The kit comes complete with 1 Junior Bench 2-frame extractor, 1 bottling bucket kit, 1 Speed King electric knife, plastic uncapping tub and 1 capping scratcher.

- ✘ **M00406KIT** 2-Frame Extractor Kit
 Actual wt. 52 lbs. **\$1,085.95**
** See page 136*

4-frame Hand Extractor Kit Power style also available

4-Frame Extractor Kits — A step up in size from the Junior Bench. The 4-frame extracting kit is perfect for the hobby beekeeper. It is available in both hand and power styles. This 4-frame extractor comes complete with extractor, 1 bottling bucket kit, 1 Speed King electric knife, plastic uncapping tub and 1 capping scratcher.

- ✘ **M00407KIT** 4-Frame Hand Extractor Kit
 Actual wt. 60 lbs. **\$1,095.95**
** See page 136*
- ✘ **M00408KIT** 4-Frame Power Extractor Kit
 Actual wt. 76 lbs. **\$1,295.95**
** See page 136*

6-frame Extractor Kit Hand style also available

6-Frame Extractor Kits — For those who prefer a radial extractor this is for you. The 6-frame extracting kit is available in both the power and hand styles. It is capable of extracting six 6¼" frames or shallow frames radially or three deep frames tangentially by using the optional baskets. The 6-frame radial extractor comes complete with extractor, 1 bottling bucket kit, 1 Speed King electric knife, plastic uncapping tub and 1 capping scratcher.

Optional baskets for deep frames sold separately.

- ✘ **M00409KIT** 6-Frame Hand Extractor Kit
 Actual wt. 60 lbs. **\$1,145.95**
** See page 136*
- ✘ **M00410KIT** 6-Frame Power Extractor Kit
 Actual wt. 77 lbs. **\$1,485.95**
** See page 136*
- ✘ **M00409B** Optional Baskets, for Deep Frames,
 Actual wt. 5.15 lbs. **\$149.95**



-- NO SUBSTITUTIONS OR PARTIAL RETURNS ON KITS --

Dadant MANUFACTURED HONEY EXTRACTORS

6-12 Frame Radial Extractor with Motor

6-12 Frame Radial Extractor — No more hand reversing of frames — uncap, load, extract, and unload. Reel capacity 6 - 9 $\frac{1}{8}$ " deep frames; 12 - 6 $\frac{1}{4}$ " shallow frames. Frame guides provide positive frame placement. Ball bearings top and bottom. Powered by specifically designed direct drive motor with manually controlled electronic speed control. 120 volt operation. All welded 24" dia. 28" tall Type 304, 20-gauge stainless steel tank with inverted coned bottom and 1 $\frac{1}{2}$ " welded fitting. 1 $\frac{1}{2}$ " plastic honey gate with barbed adapter included. (See diagram below for construction details).

Ships Freight Only

✘ **M00412** 6-12 Frame Extractor
Actual wt. 84.1 lbs. \$2,295.00
* See page 136

ALL DADANT EXTRACTORS ARE MADE WITH GAUGES OF STEEL HEAVIER THAN OUR COMPETITORS!

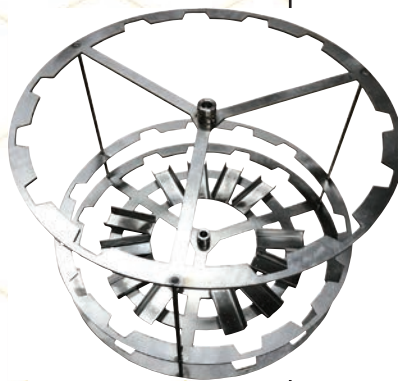

M00412



CONSTRUCTION DETAILS

6-, 12-Frame and 20-Frame Extractors (20-Frame Extractor Shown)

- Rugged Direct Drive Motor with Manually Operated Speed Control
- Piano-style SS Hinge
- Stainless Steel Lids
- Ball Bearings Top and Bottom
- Individual Frame Guides
- All Welded Stainless Reel
- Cone Bottom
- Welded Stainless Steel Fitting

The concept of the Radial Extractor has saved more time and combs for beekeepers than any other invention. Radial extractors are the quickest, easiest, and most efficient way to extract honey from the comb. Frames are placed in the reel like spokes of a wheel. The reel spins, creating a centrifugal force and honey is thrown from both sides of the comb at once.

20-Frame Radial Extractor

- 4 Section Reel
- Type 304 Stainless Steel
- 20-Gauge Stainless Steel
- Holds Any Size Frame
- 20 Individual Frame Pockets
- 30" Diameter 28" High

The ideal choice for a growing extracting operation. From a few colonies to several hundred, the 20-frame radial is excellent. Comes complete with welded drain (2" Female Pipe Thread) with 2" to 1 $\frac{1}{2}$ " reducer bushing. A powerful variable speed direct drive motor powers the unit. It has a cone bottom and is 120 volt operation.

✘ **M00446** 20-Frame Radial,
Actual wt. 96 lbs. * . . . \$2,795.00
Ships Freight Only * See page 136



M00446

MADE IN AMERICA BY US BUILT TO LAST FOR YOU

60-Frame Radial

- ½ Horsepower DC Motor
- 52" Tank Diameter
- Inverted Cone Bottom with 3" Male Center Drain
- 16-Gauge (.060) Stainless Steel Tank
- Segmented Reel Holds 60 Frames
- Smooth Reel Holds 85-90 Frames
- For smooth operation of extractor see food approved grease on page 85.

✗ **M00450** Smooth Reel
Actual wt. 800 lbs.* \$6,899.95

✗ **M00430** Segmented Reel
Actual wt. 810 lbs.* \$7,095.00
Ships Freight Only * See page 136



**Heavy-Duty
Try the Best**



Honey Master 84-Frame

- ¾ Horsepower DC Motor
- 62" Tank Diameter
- Inverted Cone Bottom with 3" Male Center Drain
- 16-Gauge (.060) Stainless Steel Tank
- Segmented Reel Holds 84 Frames
- Smooth Reel Holds 96-120 Frames
- For smooth operation of extractor see food approved grease below.

✗ **M00452** Smooth Reel
Actual wt. 1,000 lbs.* . . \$8,500.00

✗ **M00432** Segmented Reel
Actual wt. 1,010 lbs.* . . \$8,995.00

Ships Freight Only * See page 136

THE BIG RADIALS Speed Control

Extractor Speed Control: State-of-the-art for controlling up to 1 horsepower DC motors. Automatic or manual operation. On automatic, select your extracting time and let the control automatically advance the extractor speed. Easy to operate. Selector switch provides operation for all size extractors. 120 volt operation.

M00443 Actual wt. 9.8 lbs. ea \$999.95



STAINLESS STEEL TANKS AND ACCESSORIES



Storage Tanks

Stainless Steel Tanks—Heavy duty, all welded. Type 304 food grade stainless steel. (Custom welded fittings or custom tanks on request. Larger tanks available.) * See page 136

- ✘ **M00393 175 lb. Tank,**
24-Gauge SS* 14 Gal.
Flat Bottom, 14" dia., 23" ht.
1½" Nylon Gate Included
Actual wt. 12.5 lbs. . . . **\$279.95**
- ✘ **M00490 300 lb. Tank,**
24-Gauge SS* 25 Gal.
Flat Bottom, 18" dia., 24" ht.
1½" Nylon Gate Included
Actual wt. 18.35 lbs. . . **\$370.95**
- ✘ **M00491 600 lb. Tank,**
20-Gauge SS 50 Gal.
Flat Bottom, 24" dia., 28" ht.
1½" Stainless Welded Fitting
Actual wt. 42.3 lbs. . . . **\$619.95**
Ships Freight Only
- ✘ **M00492 1000 lb. Tank,**
20-Gauge SS 83 Gal.
Cone Bottom, 30" dia., 28" ht.
2" Stainless Welded Outlet
Actual wt. 51.7 lbs. . . . **\$779.00**
Ships Freight Only
- ✘ **M00563 1920 lb. Tank,**
20-Gauge SS145 Gal.
Flat Bottom, 37" dia., 36" ht.
2" Stainless Welded Fitting Outlet
Reinforced Top Rim
Actual wt. 250 lbs. . . . **\$1,219.95**
Ships Freight Only



Strainer Screens

Perforated aluminum screens in stainless frame that hooks over tank rim and nests inside tank. Used to support strainer cloth.

- ✘ **M00502 14" Screen for 175 lb. Tank**
Actual wt. 1.2 lbs. ea. . . . **\$74.95**
- ✘ **M00495 18" Screen for 300 lb. Tank**
Actual wt. 1.62 lbs. ea. . . . **\$88.95**
- ✘ **M00496 24" Screen for 600 lb. Tank**
Actual wt. 2.42 lbs. ea.*. **\$115.95**
- ✘ **M00497 30" Screen for 1000 lb. Tank**
Actual wt. 3.3 lbs. ea.* . . **\$129.95**
*** See page 136**



Stainless Covers

Stainless steel covers are one piece spun stainless steel. Plastic handle. Fits tanks with strainer screen in place.

- ✘ **M00392 175 lb. Tank Cover**
Actual wt. 1.9 lbs. ea. . . . **\$59.95**
- ✘ **M00534 300 lb. Tank Cover**
Actual wt. 2.9 lbs. ea. . . . **\$77.95**
- ✘ **M00535 600 lb. Tank Cover**
Actual wt. 4.8 lbs. ea. . . **\$102.95**
- ✘ **M00536 1000 lb. Tank Cover**
Actual wt. 6.96 lbs.. ea.. **\$149.95**

M00895

40 Inch Tank Scraper

Ease your tank cleaning. Specially shaped for cleaning all tank edges and surfaces. Durable white plastic. Actual wt. 0.9 lbs. ea.

M00895 Tank Scraper \$42.95

- ✘ **M00564 3600 lb. Tank,**
16-Gauge SS 285 Gal.
Flat Bottom, 51" dia., 36" ht.
2" Stainless Welded Fitting Outlet
Reinforced Top Rim
Actual wt. 315 lbs. . . . **\$1,920.00**
Ships Freight Only

— Custom Tanks Fabricated —
Call Us For A Quote
1-217-852-3324

HONEY GATES & VALVES PAGE 92

Pantry Tanks & Heater

"Honey Pantry" Dispensing Tanks



M00456 7½ Gallon Bottom Drain SS Tank with 1¼" welded outlet fitting. Type 304, 24-gauge Stainless. 14" dia. x 11½" tall with 4½" tall base. SS cover included.

- ✘ **M00456**
Actual wt. 13.52 lbs. ea.* **\$299.95**
*** See page 136**

M00455 10½ Gallon SS Tank with welded 1¼" side wall drain. Type 304, 24-gauge stainless, 14" dia. x 16" tall. SS cover included.

- ✘ **M00455**
Actual wt. 12.48 lbs. ea.* **\$310.95**
*** See page 136**

- ✘ **M00459 Optional 125 Watt Heater** (not shown) 120 volt heater adheres to bottom of 7½ gallon tank only. Preset for approximately 100° F.
Actual wt. 1.24 lbs. ea. **\$174.95**

COMMERCIAL FILTERS AND PUMPS



Commercial Honey Filter

Dadant's Commercial Honey Filter is a stainless steel inline honey filter which can completely filter your honey, making it ready for sale at a premium price. The closure mechanism is safer and much easier to use than band clamps. The housings are manufactured with investment cast covers and collars. Strong 3-piece design offers easy access to perforated stainless steel basket and micron – rated filter bag. Filter is 6" in diameter and 15.5" long with 1½" inlet and outlet. Engineered for honey pump flow rates of up to 5 GPM. Honey temperature must be 100°F or higher for longer filter bag use. Change filter bags before pressure reaches 40 psi. Filter bags sold separately below.

✘ **M00570** Commercial Honey Filter
Actual wt. 34.5 lbs. \$929.95

It is recommended that an air vent valve (not included) be installed when plumbing the filter.



Filter Bag

M00561 Replacement Bag Only,
Actual wt. 0.15 lbs. ea. . . . \$8.95
(for use with the Commercial Honey Filter M00570)

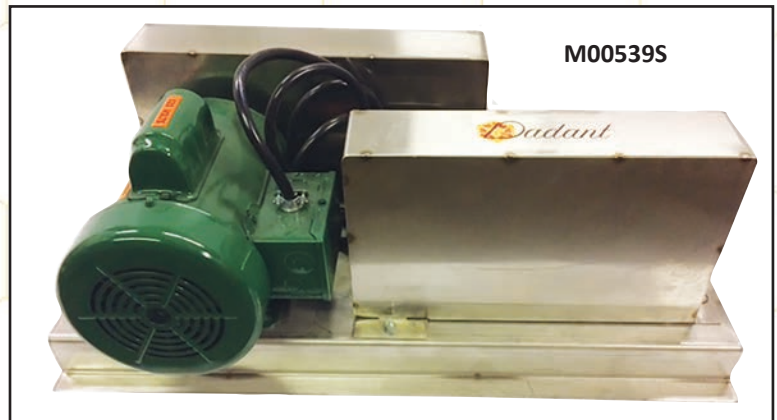

1½ Inch Honey Pump - Stainless Steel

Stainless steel, rugged, heavy-duty special 1½" gear pump with built-in pressure relief valve designed for pumping liquids like honey. 1 hp 120/240 volt, 13/8 amps motor. Two variable-speed pulleys and slotted mounts for easy adjustments allow speed ranges from 500-880 rpm. Pumps approximately 3-6 GPM of honey. Electric motor is 115/230 volts 14/7 amps. Belt guards included. Complete instructions.

Ships Freight Only

✘ **M00539S** Honey Pump, Actual wt. 146 lbs. ea.* \$2,339.00
* See page 136

BOTH PUMPS ARE NOT AVAILABLE AT ALL BRANCH LOCATIONS

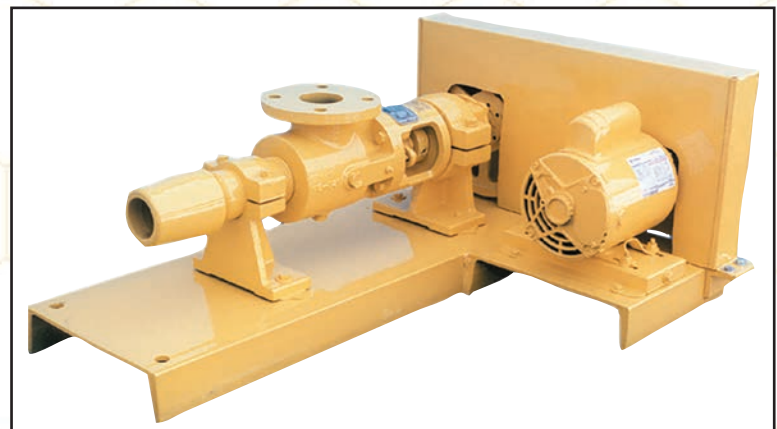

Progressive Cavity Pump Pumps Honey with Cappings

Excellent quality pump that allows solids to pass through the pump with liquids. 2½" inlet, 2" outlet. At 500 rpm, 9 gallons/minute output. Complete pumping unit comes with 2 hp electric motor — 115/230 volts 17.6/9.5-8.8 amps, belt, pulleys and guard.

Ships Freight Only F.O.B. IL Only

✘ **M00545** Pump Complete, Actual wt. 300 lbs.* \$5,199.00

* See page 136

✘ **M00546** Pump Only CALL

A POPULOUS COLONY MAY CONTAIN 40,000 TO 60,000 BEES DURING THE LATE SPRING OR EARLY SUMMER.

THE QUEEN BEE LIVES FOR ABOUT 2-3 YEARS. SHE IS THE BUSIEST IN THE SUMMER MONTHS, WHEN THE HIVE NEEDS TO BE AT ITS MAXIMUM STRENGTH, AND LAYS UP TO 2,500 EGGS A DAY.

HONEY GATES AND HONEY VALVES



M00579

1 1/2" Plastic Gate

Designed Specifically by *Dadant & Sons*
for Use With Honey
Injection Molded High Strength

Scissors action for clean cutoff against an O-ring. Adjustable gate tension. 1 1/2" pipe thread for threading into a fitting or use 1 1/2" plastic nut (provided) to install gate directly into hole in tank side. Comes with a versatile plastic barbed adapter for 1 1/2" tubing hookups. Excellent quality. Actual wt. 0.51 lbs. ea.

M00579 1 1/2" Plastic Gate \$15.95



M00457

Dispensing Valve

M00457 3/4" Dispensing Valve for "thin" liquids, will fit 7 1/2 gallon and 10 1/2 gallon Pantry Tanks. Actual wt. 1 lb. ea.

M00457 Dispensing Valve \$29.95

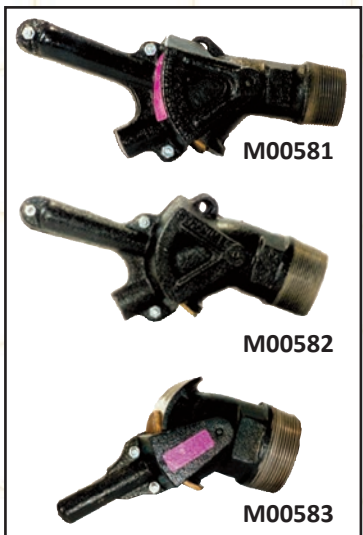

M00581

M00582

M00583

Perfection Gates

Perfection Gates are cast iron construction with brass inserted seats, male pipe threads. Used on steel drums but not recommended for use on regular stainless steel honey storage or extractor tanks. Perfection gates will fit steel drums, 16-gauge or heavier metal storage tanks.

M00581 1 1/2" Perfection Gate,
Actual wt. 4 lbs. ea. . . . \$109.85

M00582 2" Perfection Gate,
Actual wt. 5,1 lbs. ea. . . \$114.95

M00583 3" Perfection Gate,
Actual wt. 7.3 lbs. ea. . . \$173.95

1" Brass Bottle Filler

Brass Bottle Fillers are ball valves that have been machined on one end to obtain good cutoff. Both on and off lever action. Comes complete with 90° bend. 1" has female pipe threads. Stainless steel movable ball seals against nylon seats to insure very smooth action and long wear. Actual wt. 2.88 lbs.

M00585 1" Brass Bottle Filler . . . \$107.95



Offset Handle
for Easy Filling

M00585



Stainless Steel

M005855

Honey Bottling Valve — 1 Inch

A solid, stainless steel, self closing no-drip valve, 1" threads. Rising plunger valve. Spring close. Can use M005854 adapter kit for use with 7 1/2 and 10 1/2 gallon honey pantry tanks.

M005855 Honey Bottling Valve,
Actual wt. 2.52 lbs. ea. \$169.95

03-40221

Replacement Thumb Screw for 1 1/2" Plastic Gate

For the M00579 plastic gate. Ship wt. 1 oz. ea. **03-40221 Metal Replacement Thumb Screw \$1.25**

Can use with (7 1/2 gal. & 10 1/2 gal. Tank) for "thick" liquids or use the following:

M005855 SS Bottling Valve or M00585 1" Brass Filler

Adapter Kit M005854 is required to fit either valves.

M005854

Adapter Kit

M005854 Adapter Kit for Honey Bottling Valve-M005855. To fit M00455, 10 1/2 gallon Dispensing Tank, available on page 95. M005854 adapter kit will also work with M00456 7 1/2 gallon honey pantry tank. Actual wt. 1.02 lbs. ea.

M005854 Adapter Kit \$19.95



M00585, M005855 will fit tanks with 1" male thread outlet directly with no adapters. Valves can be used with other size outlets, but will require adapters.



HONEY HARVESTING

Pump Control-Strainer

15 Gallon — 12" x 12" x 32"

Collect honey directly from your extractor, strain out most foreign material, and control your honey pump in one operation. Single tank unit is all MIG welded stainless steel. Comes complete with wired float switch and strainer screens. Comes with Type 304, 16-gauge, stainless steel 1½" female pipe thread welded inlet and outlet fittings.

Actual wt. 24.35 lbs.*

Ships Freight Only.

❌ **M00558** Pump Control Strainer
..... \$729.00

* See page 136

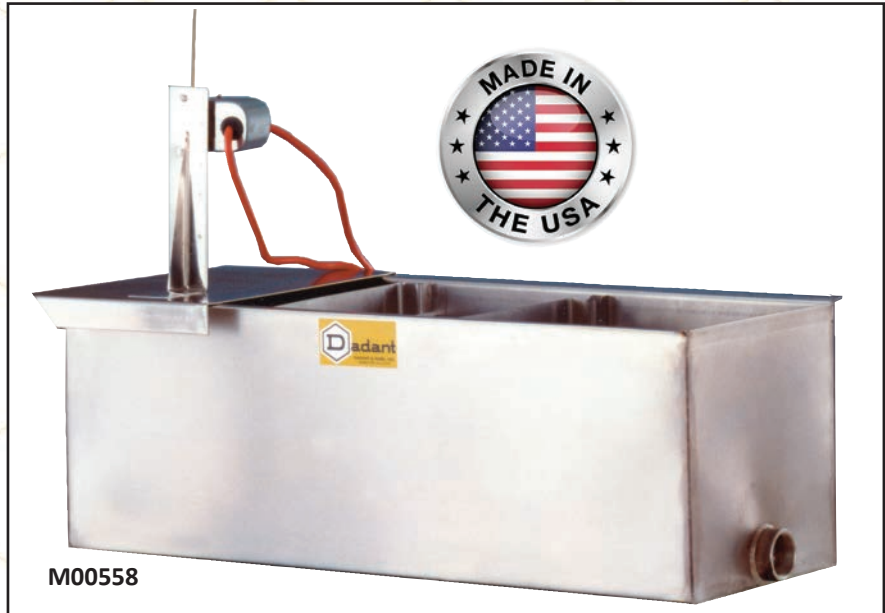

M00558

20 Gallon Water Jacketed Clarifier

Double-wall all MIG welded Type 304, 16-gauge, stainless steel construction provides a water jacket around the honey compartment. Two double baffles trap heavy and floating material. Welded tank fittings. 1½" male pipe thread inlet and 1" male pipe outlet. Complete with wired float switch, 1700 watt 120 volt heater, baffling system, and two-piece complete cover. 36¼" L x 14¼" W x 14¼" H

Actual wt. 66 lbs.*

Ships Freight Only.

❌ **M00550** 20 Gallon Clarifier
..... \$1,699.95

* See page 136



Controller 1

M00550

Flash Heater

The "HEART" of a honey packing system. Heats honey rapidly in a closed system to preserve flavor. Honey is pumped through copper coils submerged in hot water. Capacity for 100°F temperature rise in up to 1800 lbs. of honey per hour. Controllable for precise heating. 36" x 36" x 14" deep, 16-gauge, type 304, all-welded stainless steel tank. 4 - 2" female pipe thread openings provided. Includes a 0-200°F thermometer. Comes with stainless steel cover. Heaters sold separately (see page 81). Actual wt. 242 lbs. ea.*

Ships Freight Only.

❌ **M00569** Flash Heater \$2,899.95

* See page 136

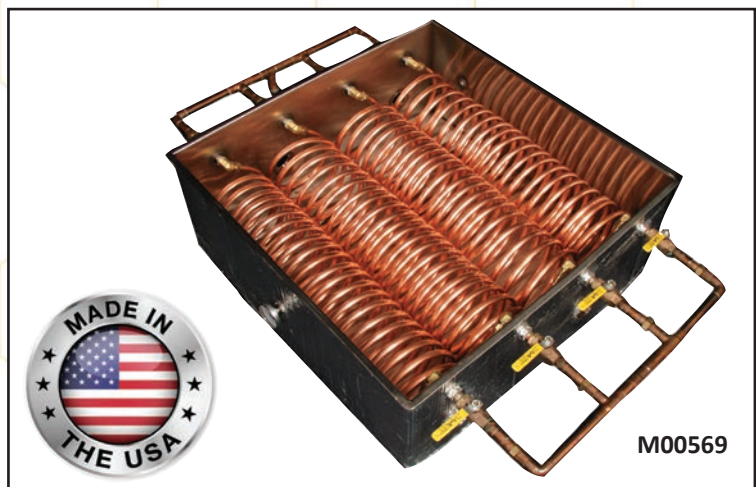

M00569

HONEY HARVESTING



**Portable Table Top Unit — Self Priming —
All Electric (120 volt) Pack From Any Bulk Container —
Easy To Adjust Fill Quantity**

Fill Master

Power Bottle Filler Excellent — No Drip Accurate — Dadant Designed — Dadant Mfg.

The Fill Master was revised last year with a higher torque motor. This allows the unit to fill bottles with 75°F honey (may see fill volume variations and colder temperatures). But accuracy of filling volume is more accurate from 100-110°F. The gear pump also works very well for creamed honey making a very smooth texture. The Fillmaster has been used by our customers to fill containers with gear oil, dressings, maple syrup and beer/wine along with other viscous products.

The Fill Master is Dadant's answer to many requests for a simple, no drip, easily adjusting, inexpensive, accurate bottle filling machine. As with any bottle filler, the unit works best with warm (110°F) honey. No special bottling tank is required as it is self-priming. You may pack from 60# buckets, storage tanks or anything that holds honey. Adjust fill level from ounces to gallons in seconds. No fill limitations. No air supply needed. A great unit at a low price.

The Stainless Steel Fill Master is made out of Type 304, 20 gauge, stainless steel. Free video — just give us a call. Branch pickup is available.

Ships Freight Only.

⊗ M006262 Fill Master, Actual wt. 85 lbs.* **\$4,899.95** * See page 136

MULTI PURPOSE — WATER JACKETED TANKS

Water Jacketed Tanks 10 Gallon Capacity

Comes with 14" stainless steel removable lid. All fittings welded, 1" male pipe thread outlet. No outlet valve supplied. Order your choice from page 92, depending on your application. 14" diameter fill area. 18" diameter x 21" height. 1700 watt, 120 volt immersion heater. Both inner and outer tank are 20-gauge, type 304 stainless steel construction.

Ships Freight Only.

✗ **M00624** 10 Gallon, Actual wt. 42.6 lbs. ea. * . . . \$1,325.95
* See page 136



**Prevents scorching,
hot spots or overheating**



M00624

Water Jacketed Tanks 25 Gallon Capacity

Eases product handling and prevents damage

- Double-Walled Tank
- Thermometer to Measure Water Temperature
- All Welded Tanks and Fittings
- Bottom Drain
- Type 304 Stainless Steel
- Water Sight Glass
- Immersion Heater Included



M00616

Comes with 18" removable Lexan clear cover. Large filling area. All fittings welded. 1" male pipe thread outlet. No outlet valve supplied. Order your choice from pages 92 & 96. 21" diameter x 31" height. 1700 watt, 120 volt immersion heater included. Both inner and outer tanks are 20-gauge, type 304 stainless steel construction.

Ships Freight Only.

✗ **M00616** 25 Gallon, Actual wt. 68 lbs. * \$1,720.00

✗ **M00617** Optional Stirring System
Actual wt. 31.15 lbs. \$949.95

✗ **M00619** Optional 24" Thermometer,
Use Only With Stirring System
Actual wt. 1.25 lbs. \$137.95

* See page 136

Many products require indirect heating to prevent scorching, hot spots or overheating, and to assist bottling, processing or material handling. This tank works like a "double-boiler" and is basically a smaller tank inside a larger tank. The space between the tanks is filled with water and an immersion heater is immersed in the water. In turn, the heated water warms the product that has been placed in the inner tank. This indirect heating is a gentler method of warming and has been found necessary to ease product handling and prevent damage to products such as honey, waxes, soaps, syrups, etc.

MULTI PURPOSE — WATER JACKETED TANKS



**70 gallon
M00628**

- Double-Walled Tank
- Bottom Drain
- All Welded Tanks and Fittings
- Type 304 Stainless Steel
- Water Sight Glass
- Immersion Heater Included
- Thermometer to Measure Water Temperature



Many products require indirect heating to prevent scorching, hot spots or overheating, and to assist bottling, processing or material handling. This tank works like a “double-boiler” and is basically a smaller tank inside a larger tank. The space between the tanks is filled with water and an immersion heater is immersed in the water. In turn, the heated water warms the product that has been placed in the inner tank. This indirect heating is a gentler method of warming and has been found necessary to ease product handling and prevent damage to products such as honey, waxes, soaps, syrups, etc.

70 Gallon Capacity

Comes with 30” Lexan clear removable cover. Large filling area. All fittings welded. 1” male pipe thread outlet. No outlet valve supplied, order your choice from this page or page 92. 33” diameter x 32” height. 4500 watt, 240 volt immersion heater included. Both inner and outer tanks are 16-gauge, type 304 stainless steel construction. **Ships Freight Only.**

- ✘ **M00628** 70 Gallon, Actual wt. 175 lbs.* \$2,895.00
- ✘ **M00629** Optional Stirring System
Actual wt. 40.15 lbs. \$999.95
- ✘ **M00619** Optional 24” Thermometer,
Use Only With Stirring System,
Actual wt. 1.25 lbs. \$137.95



**130 gallon
M00632**



130 Gallon Capacity

- ✘ **M00632** 130 Gallon, Actual wt. 353 lbs.* \$6,799.00
Call for availability * See page 136



40 Inch Tank Scraper

Ease your tank cleaning. Specially shaped for cleaning all tank edges and surfaces. Durable white plastic.

- M00895** Tank Scraper,
Actual wt. 0.9 lbs. ea. \$42.95

OUTLET VALVES



M00585

Brass Bottle Fillers are ball valves that have been machined on one end to obtain good cutoff. Both on and off lever action. Comes complete with 90° bend. 1” has female pipe threads. Stainless steel movable ball seals against nylon seats to insure very smooth action and long wear.

- M00585** 1” Brass Filler,
Actual wt. 2.88 lbs.
\$107.95



M006142

The Heated 1” Valve keeps liquid wax in valve area. No down time waiting for wax to liquify. Constant 185°-190°F.

Not recommended for use with honey.

- M006142**
Heated 1” Valve,
Actual wt. 3.72 lbs.
\$279.95

GLASS HONEY CONTAINERS

All weights listed for containers are honey weights. Other liquids may vary in weight. For example, a 12 oz. container will hold 12 ozs. of honey, but only 8 ozs. of water.

GLASS SHIPMENTS CANNOT BE INSURED. All glass shipped will be at customer's risk.



3 lb. & 5 lb. Glass Jar with Lid

Each jar makes a great container for honey and some use them exclusively for their payments to the landowner of the property the beekeepers hives are sitting on. It is also known as a yard rent jar. Both take a standard G70 closure. Lid included.

M001932 3 lb. Glass Round Quart Jar, Plastic G70 Lid, Ctn/12, 1-99 ctns. **\$24.50**
Actual wt. 11.5 lbs.

M001922 5 lb. Glass Round Jar, Plastic G70 Lid, Ctn/6, 1-99 ctns. **\$31.95**
Actual wt. 11.5 lbs.

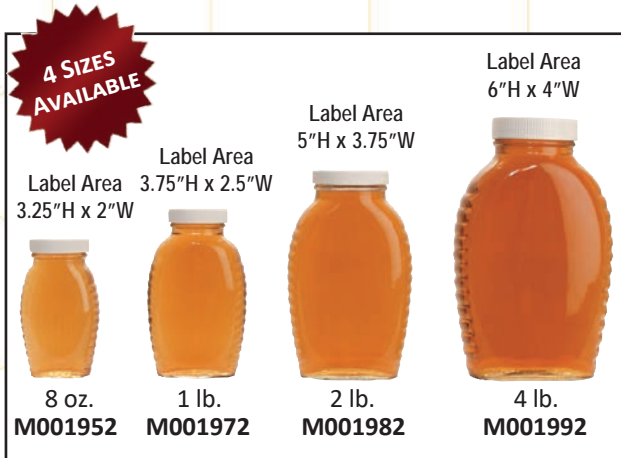

*Queenline Glass Honey Jars

Queenline Honey Jars with Plastic Lids

Jar Size	No. of Jars Per Ctn.	Lid Size	Item Number	Actual wt. Per Ctn.	Price Per Ctn. 1-99 Cartons
8 oz.	24	48mm	M001952	8.92 lbs.	\$30.95
1 lb.	24	58mm	M001972	14 lbs.	\$47.95
2 lb.	12	63mm	M001982	11 lbs.	\$38.95
4 lb.	6	G70	M001992	9.5 lbs.	\$43.95

Queenline Jars with no lids are available. Call for pricing!

Replacement lids available on page 101.



Classic Glass

Classic Glass Honey Jars with Lids

Jar Size	No. of Jars Per Ctn.	Lid Size	Item Number	Actual wt. Per Ctn.	Price Per Ctn. 1-99 Cartons
8 oz.	24	48 mm	M01132	8 lbs.	\$26.25
1 lb.	24	48 mm	M01134	13.5 lbs.	\$32.95
2 lb.	12	63 mm	M01131	10 lbs.	\$22.95

Classic Glass with NO lids are available. Call for pricing!

Please call for discounted pricing on quantities over 100 cases!

All containers priced FOB Hamilton, IL — for local prices call your nearest Dadant branch

GLASS HONEY CONTAINERS

Honey not included

Label Area
2.25"H x 1"W



M00221

Label Area
3"H x 1.25"W



M00222

Label Area
4"H x 1.5"W



M00223

12 oz. Cylinder Jars with Lids

This 12 oz. cylinder hex jar will showcase your prized honey and make it sparkle. With a wide mouth filling this jar couldn't be any easier. Lid size is 58mm. Carton of 12.

M011481 C/12
Actual wt. 4.7 lbs.
\$21.50

Label Area
3"H x 2"W



M011481

Muth Jars

A Touch of the Late 1800's

Muth jars decorated with a skep scene and the words "Pure Honey" are a great addition to any honey container collection. Cork stopper included.

Muth Jar - Carton of 36

M00221 4 oz. Actual wt. 9.58 lbs. **\$50.95**

Muth Jar - Carton of 12

M00222 8 oz. Actual wt. 4.68 lbs. **\$18.95**
M00223 16 oz. Actual wt. 9.62 lbs. **\$27.95**

Label Area
1.125"H x 2"W



M011451

Label Area
1.75"H x 3"W



M011491

Shrink Bands for Muth Jars

M00827 c/100 shrink bands For 4 oz., Actual wt. 0.05 lbs. . **\$9.95**
M00828 c/100 shrink bands For 8 oz., Actual wt. 0.1 lbs. . . **\$10.95**
M00287 c/250 shrink bands For 16 oz., Actual wt. 0.2 lbs. . . **\$8.95**

3 oz. and 12 oz. Glass Skeps with Lids

These beautiful skep jars will make the perfect honey container for yourself or as a gift to others. Hold 3 oz. or 12 oz. of honey weight by volume. 3 oz. available in c/24. 12 oz. available in c/12.

M011451 C/24 3 oz., Actual wt. 5.5 lbs. . . . **\$22.95**
M011491 C/12 12 oz., Actual wt. 6.25 lbs. . . **\$23.95**

Hex Jars

Beautifully designed hex jars are great containers for display and are exquisite when decorated creatively.

Available in 3 sizes: 5.5 oz., 9.5 oz. and 13.5 oz. Containers come with gold twist-off plastisol lids.

Hex Jar - Carton of 12

M01550 5.5 ozs., Actual wt. 3.3 lbs. **\$14.75**
M01551 9.5 ozs., Actual wt. 4.3 lbs. **\$16.75**
M01552 13.5 ozs., Actual wt. 5.8 lbs. **\$18.50**

Label Area
2"H x 6.75"W

Lid - 48mm



M01550

Label Area
2.375"H x 8.5"W

Lid - 58mm



M01551

Label Area
2.5"H x 8.5"W

Lid - 63mm



M01552

Please call for discounted pricing on quantities over 100 cases!
 All containers priced FOB Hamilton, IL — for local prices call your nearest Dadant branch

All weights listed for containers are honey weights. Other liquids may vary in weight.
For example, a 12 oz. container will hold 12 ozs. of honey, but only 8 ozs. of water.

PLASTIC HONEY CONTAINERS

Label Area
4"H x 2.5"W
M00208



BPA FREE

Label Area
5"H x 3"W
M00209



Label Area
3"H x 3.25"W
M002042



BPA FREE

Label Area
3.75"H x 4.5"W
M002052



Label Area
4"H x 2.75"W

Close-up of
hexagon pattern

BPA FREE

1 lb.
M01158



Bulk quantities do not include lids

4 Sizes Available

Label Area
3"H x 2.125"W
M01150

Label Area
3.5"H x 2"W
M01151

Label Area
4.5"H x 3"W
M01152

Label Area
5"H x 3"W
M01153

8 oz.
M01150

1 lb.
M01151

1½ lb.
M01152

2 lb.
M01153

BPA FREE



BPA FREE

3 lb.
M01159

Bulk quantities do not include lids

Close-up of
hexagon pattern



PET Oval

- ✗ **M00208** 1 lb. PET Plastic Honey Oval Plastic 58mm Lid
Carton of 12, Actual wt. 1.2 lbs. 1-99 ctns. \$16.49
- ✗ **M00209** 2 lb. PET Plastic Honey Oval Plastic 63mm Lid
Carton of 12, Actual wt. 1.9 lbs 1-99 ctns. \$22.49

Plastic Honey Bee Containers

Item Number & Description	Lid Style	Quantity	Price	Actual wt.
✗ M002042 1 lb. Plastic Honey Bee Container	Plastic 43mm Lid	Carton of 24 1-99 ctns	\$27.75	1.06 lbs.
✗ M002052 2½ lb. Plastic Honey Bee Container	Plastic 58mm Lid	Carton of 6 1-99 ctns.	\$19.00	1.05 lbs.

Inverted Plastic Jar with Hexagon Pattern with 38mm Drip-Proof Snap Cap Lids

Jar Size	No. of Jars Per Ctn.	Item Number	Actual wt. Per Ctn. lbs.	Price Per Ctn. 1-99 Cartons
1 lb.	24	M01158	2.62 lbs.	\$23.75
	300 w/lids	✗ M01158CS300	40 lbs	\$274.95

Classic Plastic Honey Jars with 38mm Snap Caps

Jar Size	No. of Jars Per Ctn.	Item Number	Actual wt. Per Ctn. lbs.	Price Per Ctn. 1-99 Cartons
8 oz.	24	M01150	1.4 lbs	\$18.75
1 lb.	24	M01151	2 lbs	\$21.75
1½ lb.	24	M01152	3 lbs	\$29.75
2 lb.	12	M01153	1.9 lbs	\$16.75

Please specify red, yellow, gold or black snap caps.
If none specified yellow will be sent.

Classic Plastic BULK Honey Jars with NO lids

Jar Size	No. of Jars Per Ctn.	Item Number	Actual wt. Per Ctn. lbs.	Price Per Ctn. 1-99 Cartons
8 oz.	550	✗ M011501CS550	30 lbs.	\$194.75
1 lb.	321	✗ M011511CS	30 lbs.	\$159.75
1½ lb.	216	✗ M011521CS	30 lbs.	\$154.75
2 lb.	168	✗ M011531CS	30 lbs.	\$119.75

Bulk DOES NOT include lids. See page 101 for lids.

3 Pound Plastic Jar with Hexagon Pattern Plastic Honey Jar with 38mm Snap Caps

Jar Size	No. of Jars Per Ctn.	Item Number	Actual wt. Per Ctn. lbs.	Price Per Ctn. 1-99 Cartons
3 lb.	6	M01159	1.44 lbs.	\$10.75
	126 (NO lids)	✗ M011591	30 lbs.	\$117.75

Replacement lids available on page 101.

Shipments of multiple case quantities may be repackaged and shipping weights may be converted to dimensional weight.

All containers priced FOB Hamilton, IL — for local prices call your nearest Dadant branch

www.dadant.com

All weights listed for containers are honey weights. Other liquids may vary in weight.
For example, a 12 oz. container will hold 12 ozs. of honey, but only 8 ozs. of water.

HONEY BEAR DISPENSERS

BPA FREE



Panel size for label
7/8" x 1 1/8"
Front/Back

M00258

2 oz. Clear Bear with caps c/50

This clear panel bear holds approximately 2 oz. of honey. Great for gifts or selling samples of your honey.

M00258
Actual wt.
1.75 lbs.
\$41.50

✗ M00258CS
c/800 with lids
Actual wt. 28 lbs.
\$334.70

IT TAKES ABOUT 556 WORKERS TO GATHER 1 POUND OF HONEY FROM ABOUT 2 MILLION FLOWERS.

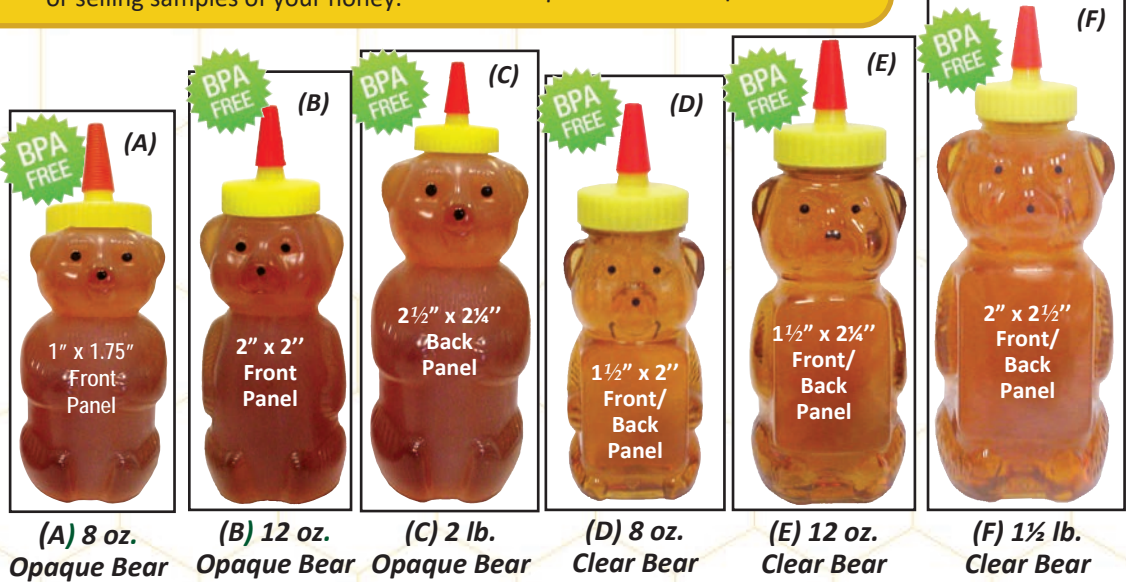

	A	B	C	D	E	F
Carton of 12 Complete with Caps & Collars	M00245 Carton of 12	M00255 Carton of 12	M00277 Carton of 12	M00245CPN Carton of 12	M00255CPN Carton of 12	No Collars M00271CPN Carton of 12
	\$13.95 Actual wt. 1.3 lbs.	\$11.95 Actual wt. 1.3 lbs.	\$29.75 Actual wt. 2.15 lbs.	\$12.75 Actual wt. 6.6 lbs.	\$11.95 Actual wt. 1.1 lbs.	\$12.45 Actual wt. 1.65 lbs.
Bulk Pack with Caps & Collars	✗ M00246 400/Case	✗ M00256 250/Case	✗ M00278 100/Case	✗ M00246CPN 396/Case	✗ M00256CPN 250/Case	No Collars ✗ M002713CPN 138/Case
	1-4 cases 5+ cases Wt. per case	\$297.95 Actual wt. per case 20 lbs. <i>* See page 136</i>	\$154.95 Actual wt. 17 lbs. <i>* See page 136</i>	\$219.95 Actual wt. 14.9 lbs. <i>* See page 136</i>	\$249.50 Actual wt. 20 lbs. <i>* See page 136</i>	\$164.50 Actual wt. 17 lbs. <i>* See page 136</i>
Bulk Pack without Caps & Collars	✗ M002461 400/Case	✗ M002561 250/Case	✗ M002762 100/Case	✗ M002461CPN 396/Case	✗ M002561CPN 250/Case	✗ M002712CPN 138/Case
	1-3 cases 4-19 cases 20-39 cases 40-79 cases 80+ cases Wt. per case	\$242.95 Actual wt. 16.96 lbs. <i>* See page 136</i>	\$85.50 Actual wt. 14.5 lbs. <i>* See page 136</i>	\$189.75 Actual wt. 15.16 lbs. <i>* See page 136</i>	\$142.95 Actual wt. 17.9 lbs. <i>* See page 136</i>	\$95.50 Actual wt. 15.1 lbs. <i>* See page 136</i>

All bear lids are 38mm whether it's snap cap or spout. Caps & Collars available separately on page 101.
Shipments of multiple case quantities may be repackaged and shipping weights may be converted to dimensional weight.
All containers priced FOB Hamilton, IL — for local prices call your nearest Dadant branch

1-888-922-1293

HONEY CONTAINERS AND ACCESSORIES

Snap Caps & Seals

for 38mm Containers with Tamper Resistant Seals

Snap Lock Caps have given 38mm lid containers a new look. Easy clean dispensing. Yellow, red, gold or black, 1-piece snap cap with hinge and a built-in dispensing nozzle. Fits all plastic squeeze dispensers. Comes with tamper resistant seal.

M00844 Actual wt. 0.0124 lbs. each
1-1699 \$0.16 ea.
1700+ \$0.14 ea.

M00844R Actual wt. 0.0124 lbs. each
1-1699 . . . \$0.16 ea.
1700+ . . . \$0.14 ea.

M00844G Actual wt. 0.0124 lbs. each
1-1699 . . . \$0.16 ea.
1700+ . . . \$0.14 ea.

M00844B Actual wt. 0.0124 lbs. each
1-1699 . . . \$0.16 ea.
1700+ . . . \$0.14 ea.

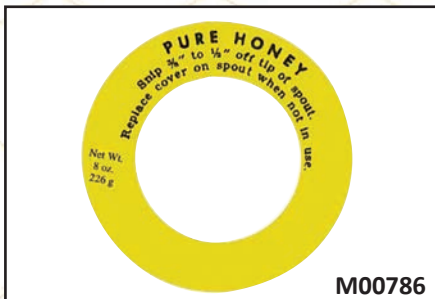

Collars for Squeeze Bears

Price per 1000, Actual wt. 0.9 lbs.

M00786 Collar for 8 oz. Bear
M00788 Collar for 12 oz. Bear
M00792 Collar for 2 lb. Bear
1-4 Cartons \$65.50 per 1000
5-9 Cartons \$63.50 per 1000
10-19 Cartons \$62.50 per 1000
20+ Cartons \$61.50 per 1000

Spout Cap (38 mm)
Fits 8 oz., 12 oz.,
1½ lb. & 2 lb. Bears

M00787

M00787 Spout Cap,
Actual wt. 0.0126 lbs. ea. \$0.22

M007871 Carton of 1250,
Actual wt. 16.5 lbs. ea.
1-3 \$245.50 per Carton
4-7 \$242.75 per Carton
8-15 \$240.75 per Carton
16+ \$238.50 per Carton



1 lb. Skep

M00273 1 lb. Skep with Snap Caps
Actual wt. 1.7 lbs.
Carton of 12 \$16.75

Bulk Pack with Snap Caps

M002744 250/Case
1-4 cases \$175.95
5+ cases \$166.95
Actual wt. per case 21.56 lbs.

Bulk Pack without Snap Caps

M002745 250/Case
1-3 cases \$129.95
4-19 cases \$125.95
20+ cases \$123.95
Actual wt. per case 20.56 lbs.

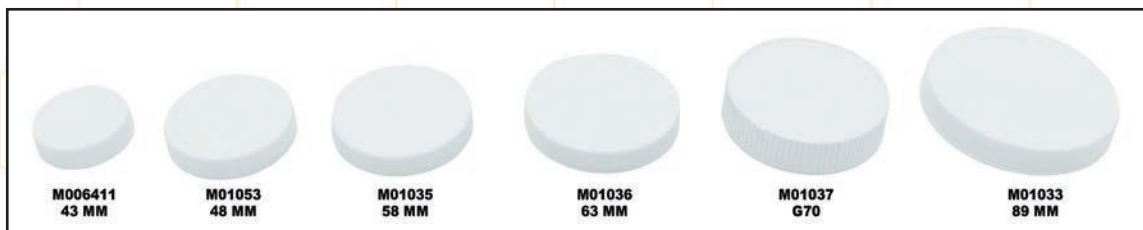

Lids Only — Plastic

Size	43 mm	48 mm	58 mm	63 mm	G70	89 mm
Plastic	M006411	M01053	M01035	M01036	M01037	M01033
	100 .20 ea. 3,000 .19 ea.	100 .19 ea. 2,500 .16 ea.	100 .20 ea. 1,650 .18 ea.	100 .20 ea. 1,500 .18 ea.	100 .23 ea. 800 .21 ea.	100 .29 ea. 624 .28 ea.
	Actual wt. per case 0.0108 lbs.	Actual wt. per case 0.012 lbs.	Actual wt. per case 0.018 lbs.	Actual wt. per case 0.02 lbs.	Actual wt. per case 0.026 lbs.	Actual wt. per case 0.05 lbs.

Minimum Quantity (100 ea. per size & style)

Shipments of multiple case quantities may be repackaged and shipping weights may be converted to dimensional weight.

HONEY CONTAINERS AND ACCESSORIES

M00280
3 lb.
Jugs



M00281
5 lb.
Jugs





3 lb. and 5 lb. Plastic Honey Jugs

With 38 mm Yellow Ratchet Style Lids

Great Containers for Packing Yard Rent Honey

- | | |
|---|---|
| <p>M00280 3 lb. Honey Jug
150 Jugs per case
Actual wt. 20 lbs. per case*</p> <p>1-5 Cases . . . \$119.50 per Case
6+ Cases . . . \$107.50 per Case</p> | <p>M00281 5 lb. Honey Jug
120 Jugs per case
Actual wt. 22 lbs. per case*</p> <p>1-5 Cases . . . \$110.75 per Case
6+ Cases . . . \$108.75 per Case</p> |
|---|---|
- * See page 136



Tamper Resistant Seals For 38mm Lids

- M00821** Carton of 250,
Actual wt. 0.1 lb. per carton
- 1-4 **\$14.50**
5+ **\$14.25**

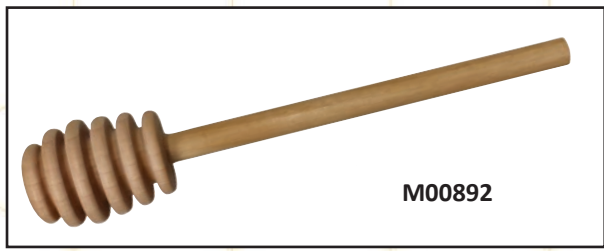

M00892

Wooden Honey Dipper

The classic wooden honey dipper. Sold individually.
M00892 Actual wt. 0.05 lbs. **\$2.50**

Shrink Bands Tamper Protection

Make your product tamper resistant. Shrink Band fits over lid. When heat is applied, band shrinks tightly around the base of the lid and container neck. (Hot-air hair dryer works as a heat source).

M00287, 48 mm Shrink bands Actual wt. 0.2 lbs. Carton of 250 \$8.95	4 Ctns or more \$8.95 ea
M00288, 58 mm Shrink bands Actual wt. 0.25 lbs. Carton of 250 \$10.50	4 Ctns or more \$10.50 ea
M00289, 63 mm Shrink bands Actual wt. 0.25 lbs. Carton of 250 \$10.50	4 Ctns or more \$10.50 ea
M00290, 670 Shrink bands Actual wt. 0.35 lbs. Carton of 250 \$11.25	4 Ctns or more \$11.25 ea





M00251

Economy Plastic Cut Comb Box

Clear PETE Plastic — 3 $\frac{3}{4}$ " x 3 $\frac{3}{4}$ "
Excellent Product Visibility — Lightweight
(use with Comb Cutter, M00938 see page 38)

- M00251** Ctn/50, Actual wt. 1.85 lbs. . . **\$18.95 per Carton**
- M002521** Ctn/ 600, Actual wt. 24 lbs.*
- 1-2 Ctns **\$185.95 per Carton**
3+ Ctns **\$183.95 per Carton**





M00250

Plastic Cut Comb Boxes

4 $\frac{1}{8}$ " x 4 $\frac{1}{8}$ " for Cut Comb Honey
Made from crystal clear hi-impact polystyrene
(For use with Comb Cutter, M00937 see page 38)

- M00250** Ctn/12, Actual wt. 2.25 lbs.
- 1-9 Ctns **\$29.75 per Carton**
10 & Up Ctns **\$28.75 per Carton**
- M00253** Ctn/100, Actual wt. 18.5 lbs.
- 1-5 Ctns **\$179.75 per Carton**
6+ Ctns **\$176.75 per Carton**

Shipments of multiple case quantities may be repackaged and shipping weights may be converted to dimensional weight.

HONEY CONTAINER LABELS



Security Labels

Roll of 250

Actual wt. 0.85 lbs.

- M01163 48mm \$23.50
- M01164 58mm \$23.50
- M01165 63mm \$23.50
- M01166 70mm \$23.50



Botulism Label

1½" x ¾"

M00987 Botulism label

Actual wt. 0.85 lbs.

Roll of 250 \$12.50



Liquifying Label

1½" x ¾"

M00989 Liquifying label

Actual wt. 0.85 lbs.

Roll of 250 \$12.50



Honey Labels

Attractive Pressure Sensitive Honey Labels

Yellow, black, and red on white background. Easily applied — peel label from backing and apply to honey jars. Not for use on honey bears.

- M00853 Small Roll Labels, 2½" x 2¾"
250/roll, Actual wt. 0.4 lbs. . . . \$16.25 each
- M00854 Large Roll Labels, 3¼" x 3¼"
250/roll, Actual wt. 0.85 lbs. . . . \$17.75 each

Sample 8 oz. Label

Nutrition Facts
Serving Size 1 Tbsp (21g)
Servings Per Container 11

Amount Per Serving	% Daily Value*
Calories 60	
Total Fat 0g	0%
Sodium 0g	0%
Total Carbohydrate 17g	6%
Sugars 16g	
Protein 0g	0%

*Percent Daily Values are based on a 2,000 calorie diet.

Actual Label Size:
2" wide x 2¾" high
Actual wt. 0.2 lbs.

Nutrition Labels
Pressure Sensitive
Self Adhesive

8 oz.	M00990
12 oz.	M009905
1 lb.	M00991
1½ lbs.	M009915
2 lbs.	M00992
2½ lbs.	M009925
3 lbs.	M00993
4 lbs.	M00994
5 lbs.	M00995

Quantity	Price
Per 100	\$8.25/100
Per 500	\$7.75/100
Per 1000	\$7.25/100

Nutrition Labels are for use with Queenline, Gamber Glass and Plastic only.



Old Dadant truck loading beehives

Custom Honey Labels
Royal Printing, Quincy, IL
ph: 217-222-0617
email: artwork@royal-printing.com

PLASTIC BULK HONEY CONTAINERS



M00206

1 Gallon (12 lbs.) Round Plastic Jar

A translucent jar with a wide mouth plastic lid - a superb container for the larger customer.

- ✗ M00206 Carton of 4 with lids.
Actual wt. 2.3 lbs. per Carton.
1-48 \$17.95 per Carton
49+ \$16.95 per Carton

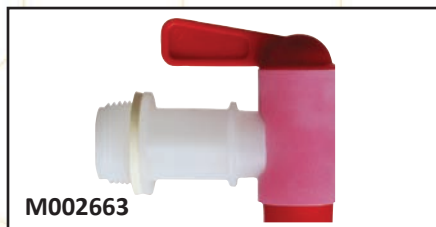

M002663

3/4" Plastic Faucet

3/4" Plastic Faucet threads into the center of 2 1/4" screw cap. (Not a clean cutoff with honey). Works best with "thin" liquids. Actual wt. 0.05 lbs. ea.

- M002663 \$6.25



M00212

5 Gallon (60 lbs.) White Plastic Pail

Comes complete with tight fitting lid with seal. Bucket is heavy gauge white plastic and has a strong, well-attached bail with hand grip.

- ✗ M00212 Actual wt. 2.8 lbs. ea.
1-99 Pails \$8.25 ea.
400-499 Pails \$8.10 ea.
500-999 Pails \$7.95 ea.
1000+ Pails \$7.85 ea.



M00238

2 Gallon White Plastic Pail

This pail has the same durable characteristics as the 5 gallon pail described above. Comes complete with tight sealing lid and plastic bail with hand grip.

- ✗ M00238 Actual wt. 1.08 lbs. ea.
1-99 Pails \$5.75
100+ Pails \$5.50

BPA FREE



M00266

5 Gallon (60 lbs.) Container

This is molded from high strength translucent plastic and comes with 2 1/4" screw lid. An ideal container for long-term storage or for filling smaller jars by using a gate accessory (sold separately). Can be used many times and for many purposes.

- ✗ M00266 Actual wt. 1.24 lbs., ea.
1-44 \$14.95 ea.
45-899 \$14.50 ea.
900+ \$13.65 ea.



03-40221

Metal Replacement Thumb Screw

For use with Dadant's specially designed 1 1/2" scissor gates M002664 and M005792. Actual wt. 0.05 lbs ea.

- 03-40221 \$1.25

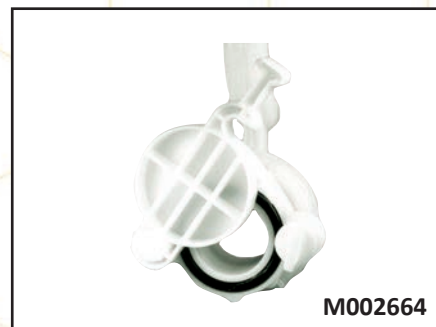

M002664

1 1/2" Plastic Scissors Gate In Cap

Dadant's specially designed gate mounted in a 2 1/4" screw cap that fits the M00266 container. Adjustable gate, clean cutoff, durable high strength plastic. Actual wt. 0.3 lbs. ea.

- M002664 \$19.95



M005792

1 1/2" Plastic Scissors Gate

Dadant's specially designed gate that fits the M00218 container (pg. 80). Adjustable gate, clean cutoff, durable high strength plastic. Actual wt. 0.31 lbs. ea.

- M005792 \$13.50



M00320

Pail Holder Stainless Steel

This tool helps you collect every last drop of honey when transferring honey from a bucket to a storage tank. Clean, neat and no longer do you have to hold the pail while the last of the honey drains out. Simply place pail in holder and move on to the next job while honey drains completely out of the pail. Actual wt. 0.71 lbs. ea.

- M00320 \$31.95



M009453

Lid Removing Tool

Lid Removing Tool for Plastic Pails is lightweight, high strength "space age" plastic. Very helpful for removing lids from the 2 and 5 gallon pails.

- M009453 Actual wt. 0.2 lbs. ea. \$10.75

Shipments of multiple case quantities may be repackaged and shipping weights may be converted to dimensional weight.

HONEY REFRACTOMETERS

Checks Moisture Content of Honey

Honey Refractometers are precision instruments made for quick determination of the moisture content of honey. Built-in visual scale covers a range of moisture content. Only a drop of honey is necessary to quickly measure the moisture content.



Misco Honey Refractometer*

Great for hobby and commercial beekeepers. The MISCO Refractometer will provide you with an accurate digital reading of your honey's moisture content. Easy to use and understand. Measures moisture w/in +/- .01%. Actual wt. 0.7 lbs.

M00600
Misco Honey Refractometer
..... \$399.95

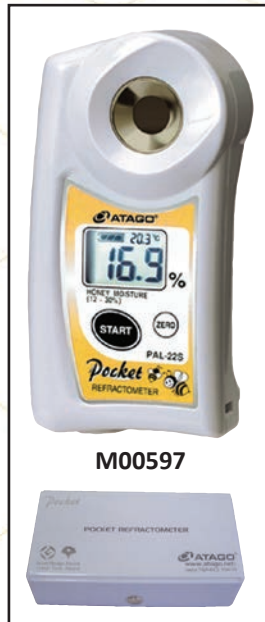

Pocket Digital Honey Refractometer*

Top Quality Refractometers
ATAGO brand

- Dependable!!
- Accurate!!

M00597
Pocket Digital Honey Refractometer
Actual wt. 0.45 lbs. ea.
..... \$449.95

*Top quality Atago brand. World renowned in the food industry for its dependability and accuracy.

**ONLY AVAILABLE at
Hamilton, IL location**



Atago Master Honey Refractometer*

Top quality Atago Brand. World renowned in the food industry for its dependability and accuracy.

M01976 Master Refractometer
Actual wt. 0.4 lbs. ea. \$389.95



Standard Refractometer*

High Quality — Low, Low Price!

M00596 Standard Refractometer
Actual wt. 0.95 lbs. ea. . . . \$112.95

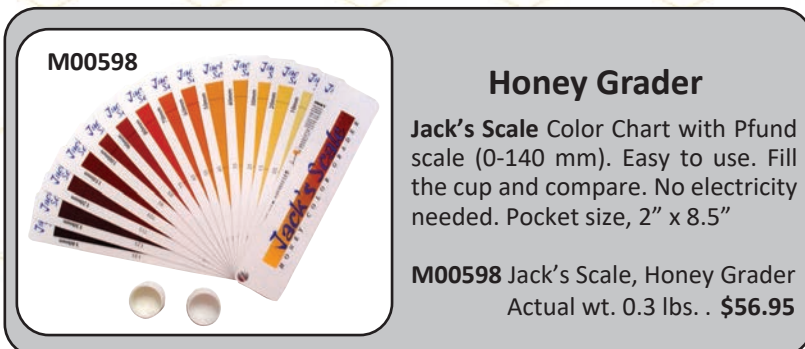

Honey Grader

Jack's Scale Color Chart with Pfund scale (0-140 mm). Easy to use. Fill the cup and compare. No electricity needed. Pocket size, 2" x 8.5"

M00598 Jack's Scale, Honey Grader
Actual wt. 0.3 lbs. . \$56.95

*Cannot ship outside of the U.S.

AMERICAN BEE JOURNAL

The Beekeeper's Companion Since 1861



Call or Email for a Free Sample Copy

1-888-922-1293 or

info@americanbeejournal.com

www.americanbeejournal.com



Embossed Binder for American Bee Journal

Protect your back issues of the American Bee Journal - holds 12 issues of ABJ.

An attractive "leather look" gold embossed magazine binder. Sturdy vinyl covers open flat.

Binder for American Bee Journal
M00080 \$14.95

American Bee Journal strives to keep beekeepers informed about new developments, beekeeping management practices, advances in bee research, and beekeeper success stories. With regular columnists and articles from around the globe, this magazine is essential reading for all beekeepers. Features include:

- Plain Talk Beekeeping: The basics ... and then some by James E. Tew
- Scientific Beekeeping by Randy Oliver
- The Curious Beekeeper by Rusty Burlew
- Bees & Beekeeping: Past & Present by Dr. Wyatt Mangum
- The Classroom, a question and answer column written by Jamie Ellis
- News and Events, the latest industry news and upcoming events
- The Marketplace, a classified section for beekeepers



2024 Rates

US Domestic Rates

1 year \$34.00 M00081
2 years \$62.00 M00082
3 years \$86.00 M00084

Canadian Surface Mail

1 year \$55.00 M000811SC
2 years \$103.00 M000821SC

Foreign Surface Mail

1 year \$66.00 M000811SF
2 years \$119.00 M000821SF

Digital Subscription

1 year \$21.00 M00081D
2 year \$42.00 M00082D

DADANT PUBLICATIONS

The Hive and the Honey Bee 2015 Edition

The 2015 edition of *The Hive and the Honey Bee* continues a 162 year tradition started by the father of American beekeeping, the Rev. Lorenzo Lorraine Langstroth. Langstroth entrusted the continuation of this book to his trusted friends Charles Dadant and his son, C.P. Dadant. Over the years “The Bible of American Beekeeping” has been continually updated and enlarged to meet the needs of a growing and changing beekeeping industry.

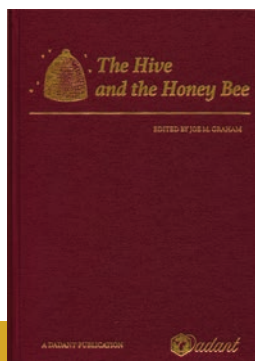

This new edition is 27% larger than the 1992 edition and is composed of 29 chapters written by a staff of 44 beekeeping experts. In addition, it has 660 photos (most of them in 4-color) and 151 drawings, graphs and tables. The 2015 edition is truly a complete beekeeping library in one book. Professionally indexed for easy information searches. Hardcover, 1057 pages. Actual wt. 5.35 lbs.

M00010 . . . \$56.15

American Honey Plants

Authored by honey plants expert Frank Pellett, this classic book on American honey plants has been reprinted in its entirety. Recognized as the best and most comprehensive book ever written on American honey plants, this volume has been out of print and hard to find for many years. Order your copy now while supplies last! Beekeeping artist Roby Baer has provided a wonderful new color cover that makes this book a true collector’s volume. Softcover, 467 pages. Actual wt. 1.95 lbs.



M00125 . . . \$25.70



First Lessons In Beekeeping

The new *First Lessons in Beekeeping* introduces the prospective beekeeper to the basics of beekeeping through easy-to-understand text and 150 color photos on honey bee biology, beekeeping equipment, management, honey production and processing, as well as disease diagnosis and treatment. In the preface to this book, author Keith Delaplane says of his first book on beekeeping, “Its pages opened to me a golden world of honey bees and beekeeping and guided my stumbling steps that first spring season. My story is but one of thousands who have passed through the door opened by Dadant’s little book.” That “little book” was the 1968 edition of Charles P. Dadant’s 1917 classic *First Lessons in Beekeeping*. Dadant’s book and its succeeding editions have been America’s first stop for beginning beekeepers for over 90 years. For the latest edition, Delaplane honors the tradition of sticking to the basics, while fully engaging the new realities of beekeeping in the 21st century. Here in this book is everything you need to know to become a successful beginning beekeeper. Also available in Spanish. Softcover, 166 pages. Actual wt. 0.75 lbs.



M00001 . . . \$9.20

M00001S . . . \$9.20 (Spanish version)



Outapiaries and Their Management

This rare volume written by M.G. Dadant was first printed in 1919 and has been out of print for many years. Now Dadant & Sons has reprinted it in its entirety, along with all of its interesting and historical photographs. This is one of the few books in existence written exclusively on the subject of establishing and managing new beeyards. Its good advice is still relevant today and its historical significance makes it a real collector’s item. Softcover, 124 pages. Actual wt. 0.35 lbs.



M00030 . . . \$9.20

Dadant System of Beekeeping

C.P. Dadant’s excellent instructional book on his beekeeping methods was popular for many years after it was first published in 1920. Now Dadant & Sons has reprinted it, along with a new cover that features historical photos of C.P. Dadant working his hives, as well as photos of his home beeyard and a personal portrait. This book contains a wealth of practical beekeeping and historical information. Softcover, 115 pages. Actual wt. 0.35 lbs.



M00029 . . . \$9.20

Restocking fee of 35% for all pre-approved book returns

www.dadant.com

Dadant Honey Bee Study Prints

These 12 beautiful 13" x 18" color enlargements depicting various honey bee behavioral characteristics and beekeeping scenes are excellent for the classroom, bee meetings and exhibits. Ideal for home, office, and honey house display. Printed on the back of each color photo is instructional material—tells what can be observed and learned from the picture,



asks questions, gives additional information on the subject, and suggests other sources of information.

Actual wt. 1.35 lbs.

M00020 . . . \$27.75
per set

Raising Honeybee Queens

Raise your own superior queens and you'll never need to buy bees again! This fully illustrated guide makes self-sufficient beekeeping accessible to everyone. If you've ever raised queens, this book will give



you confidence to start and succeed. If you are an experienced queen breeder, you will find a slew of tips to make each step of the process even better. Learn from a professional queen breeder with over 30 years' experience, and your beekeeping will never be the same after reading this book. Over 150 full-color photographs, drawings, and diagrams. Concise, well-organized guide. Actual wt. 0.98 lbs.

M02315 . . . \$29.85

The Classroom — Beekeeping Question & Answers

Jerry Hayes, our Classroom writer for the *American Bee Journal*, has put together a huge selection of the most asked beekeeping questions and answers that have been sent to *The Classroom* over the years. Great for the beginner or seasoned veteran. Book

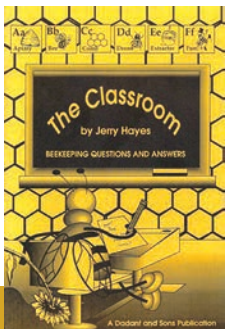

chapters deal with management, bee biology, diseases, parasites and treatment, pesticides, swarming, moving bees, pollination, equipment, honey, propolis, stings, queens and much more! Honey gold softcover. 300 pages with photos. Learning really can be fun! Actual wt. 1.15 lbs.

M00069 . . . \$12.30

Contemporary Queen Rearing



According to the late author, Dr. Laidlaw, "Contemporary Queen Rearing is still the best book I have written on practical queen rearing." Information on producing virgin queens, mating the queen, use of queens, package bee production, stock maintenance and much more useful information.

Softcover, 199 pages. Actual wt. 0.7 lbs.

M00065 . . . \$12.90

Mites of the Honey Bee

This is a must-have book for any beekeeper who wishes to understand the tracheal and varroa mite problems in the United States and the potential for control of these two serious honey bee pests. Twenty-seven

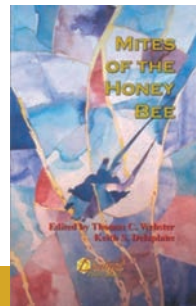

expert authors have come together to write 18 concise chapters on *Mites of the Honey Bee*. This 300-page hardcover book is amply illustrated with photos, drawings and graphs to augment the text. By Thomas C. Webster and Keith S. Delaplane. Actual wt. 1.4 lbs.

M00095 . . . \$10.25

Mating Biology of Honey Bees (*Apis mellifera*)

Authors Gudrun Koeniger, Nikolaus Koeniger, Jamie Ellis, and Lawrence Connor teamed up to write this unique book on the mating biology of honey bees. This hardcover book is amply illustrated with color photos. Bee expert Dr. Marla Spivak at the University of Minnesota says, "Here is



a book that allows you to brush up on all the mind-bending details about honey bee mating biology ... Bee sex is complex and beautiful and fortunately, there are still mysteries for future researchers to unravel." Hardcover, 155 pages. Actual wt. 0.95 lbs.

M02311 . . . \$32.95

History of American Beekeeping

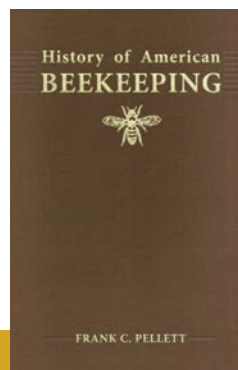

This is one of the few comprehensive books ever written on the history of American beekeeping. Authored by the late *American Bee Journal* editor, Frank C. Pellett, in 1938 this once very rare book has been reprinted in its entirety, along with its original historical photos. This is a fascinating and valuable historical document that details the rise of American beekeeping and the beekeeping pioneers who made it happen. Hardcover, 213 pages. Actual wt. 1.05 lbs.

M00072 . . . \$36.05

Restocking fee of 35% for all pre-approved book returns

1-888-922-1293

INCREASE ENJOYMENT AND PROFIT WITH KNOWLEDGE

The Beekeeper's Handbook

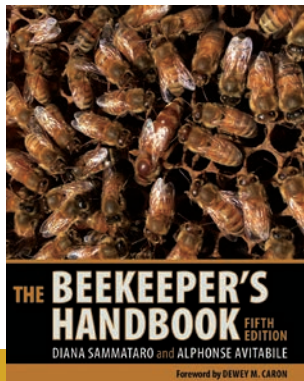

Diana Sammataro and Alphonse Avitabile have created the best single-volume guide to the hobby and profession of beekeeping. The Beekeeper's Handbook provides step-by-step instructions for setting up an apiary, handling bees, and working throughout the season to maintain a healthy colony and a generous supply of honey. Paperback, 368 pages. Actual wt. 0.14 lbs.

M000945 . . . \$29.95

Beekeeping for Dummies 5th Edition

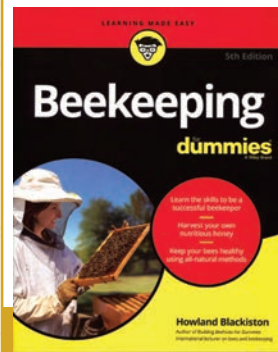

Fully revised with the latest information, this 5th Edition covers new updates on medications, nutrition, bee health, and winter survival as well as guidance for what you need to do in your first and second seasons. Valuable resources and professional advice help you and your bees succeed! Softcover, 480 pages. Actual wt. 1.5 lbs.

M023145 . . . \$24.99

A Beekeeper's Diary — Self Guide to Keeping Bees 2nd Edition

Do you want to be a beekeeper and need help on how to start? Charlotte Ekker Wiggins has written the definitive guide to beginning beekeeping.

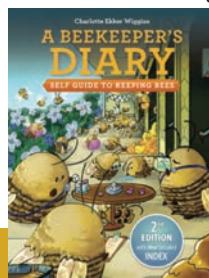

This diary will guide you on how to start, troubleshoot and successfully develop basic beekeeping skills and practices. The information in this easy to use guide, with handy check lists and tips, will answer your beginning beekeeping questions plus much more! Paperback, 304 pages. Actual wt. 1.3 lbs.

M01737 . . . \$34.95

The Small Hive Beetle *Aethina tumida* Murray

The importance of the role played by honey bee pests in the world is becoming more recognized each year, not only because of attention given to the pest species, such as the varroa mite and small hive beetle, but also because of the increasing realization that honey bees are extremely valuable to nature and humanity. The author, Wm. Michael Hood, is Professor Emeritus of Entomology, Emeritus College, Clemson University, South Carolina, USA Softcover, 142 pages. Actual wt. 0.59 lbs.

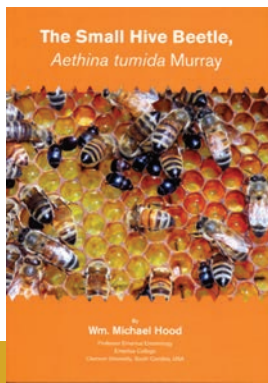

M02316 . . . \$23.70

The Beekeeper's Problem Solver

Author James Tew writes about 100 common problems that beekeepers might encounter while working their bees or extracting their honey. Dr. Tew answers these questions in clear and simple terms. From hive management to diseases and from equipment to honey production, each key area is tackled in depth, with photographs, practical tips, and useful insights. Softcover, 223 pages. Actual wt. 1.25 lbs.

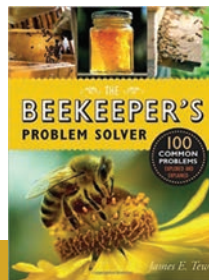

M02310 . . . \$20.60

Honey Bee Biology and Beekeeping 3rd Edition

First released in 1999, Honey Bee Biology and Beekeeping is widely accepted as a major textbook of Apiculture (beekeeping). **This is the third major revision of the text.** It explains bee and beekeeping basics in a manner meaningful to people who lack an extensive background in biology. Yet it is not over simplified, and provides a meaningful source of beekeeping information for the informed beekeeper. The Third Edition has been carefully edited, updated and expanded to 480 pages. New chapters have been added, as have colorful new graphics and photographs. The Glossary has also been expanded.

This comprehensive textbook easily replaces many beginner books while adding comprehensive details of bee biology essential to becoming a successful beekeeper and student of the honey bee. Features many new full-color photos by the authors, selected beekeeper-photographers, as well as new color drawings by Jon Zawislak.

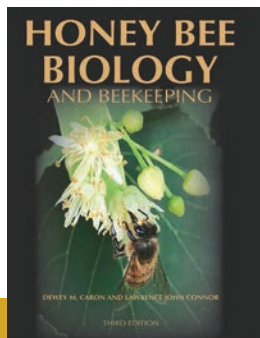

M000733 . . . \$90.00

Natural Beekeeping by Ross Conrad

Author Ross Conrad has been hailed by many beekeepers for his "organic approaches to modern apiculture." Ross believes that many beekeeper disease and pest problems can be solved without using harmful chemicals. With news that some chemical honey bee disease and pest treatments are no longer working, Ross says, "It's time for a new approach. *Natural Beekeeping* offers a holistic, sensible alternative to conventional chemical practices by proposing a program of natural hive management." Softcover, 240 pages. Actual wt. 1.9 lbs.

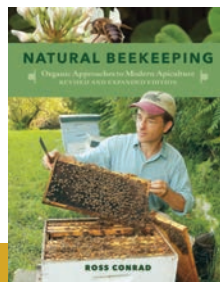

M00049 . . . \$36.05

Restocking fee of 35% for all pre-approved book returns

www.dadant.com

Comb Honey Production

Wicwas Press has reprinted Dr. Roger Morse's classic book on the specialized art of comb honey production. No other beekeeping product on the market is more natural or more delicious than comb honey. Even though comb honey production might eliminate your need for some costly honey house equipment such as extractors and bottlers, this specialized form of honey production requires a few changes in your bee management in order to maximize your comb honey yield, while not sacrificing any quality. Softcover, 128 pages. Actual wt. 0.45 lbs.

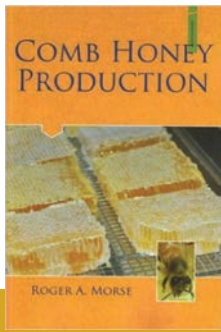

M02313 . . . \$26.80

Commercial Beekeeping: A Field Guide

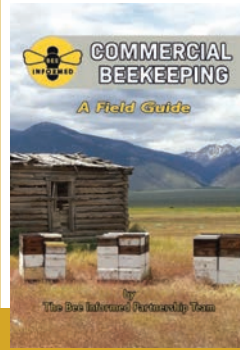

Bee Informed Partnership's "Commercial Beekeeping - A Field Guide" pocket guide is full color and has 269 pages of information. Dimensions of 4 x 6 x 0.5". Three years in the making, this publication includes a wealth of information that covers everything beekeepers may want to know to improve their beekeeping and take their operation to the next level. Softcover, 269 pages. Actual wt. 0.525 lbs.

M02318 . . . \$22.65

The Backyard Beekeeper 4th Edition

An Absolute Beginner's Guide to Keeping Bees in Your Yard and Garden

Now in its 4th edition, makes the time-honored and complex tradition of beekeeping an enjoyable and accessible backyard pastime that will appeal to urban and rural beekeepers of all skill levels. What's New? - Information for Urban Bees and Beekeepers - Using Your Smoker the Right Way - Better Pest Management - Providing Consistent and Abundant Good Food - Keeping Your Hives Healthy. With this complete resource and the expert advice of former Bee Culture editor Kim Flottum, your bees will be healthy, happy, and more productive. Softcover, 240 pages. Actual wt. 1.6 lbs.

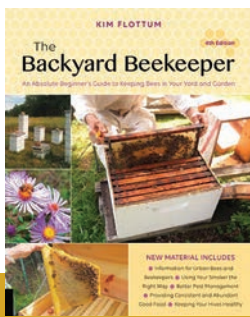

M019804 . . . \$25.75

Bee-sentials — A Field Guide



A beekeeping book you have been looking for--a basic book with some 'meat on its bones' for continued study by new and not-so-new beekeepers. This is a book that can be thrown into a computer bag or backpack and read on an airplane or beside a lake in the woods. 25 Colorful pages of honey plants. Softcover, 208 pages. Actual wt. 0.9 lbs.

M00077 . . . \$25.75

Attracting Native Pollinators

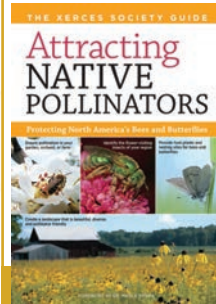

Bees, wasps, butterflies, moths, flies and some beetles pollinate more than 70 percent of flowering plants, but North America's native pollinators face multiple threats to their health and habitat. The Xerces Society offers a complete action plan for protecting these industrious animals by providing flowering habitat and nesting sites. Softcover, 371 pages. Actual wt. 2.3 lbs.

M00111 . . . \$30.85

Two Million Blossoms — Discovering the Medicinal Benefits of Honey

Author Kirsten Traynor has carefully researched and interviewed many experts for this well written and informative book that chronicles the medicinal use of honey "from ancient civilizations until the advent of antibiotics." "New scientific findings from around the world demonstrate honey heals chronic wounds, beats antibiotic-resistant superbugs, eliminates tissue scarring, reduces brain damage, improves memory and minimizes the harmful side-effects of cancer treatments. An easily assimilated antioxidant, honey proves more effective than over-the-counter cough medicines, acts as a natural laxative, stimulates good intestinal flora, and alleviates spring allergies." Softcover, 258 pages. Actual wt. 1.3 lbs.

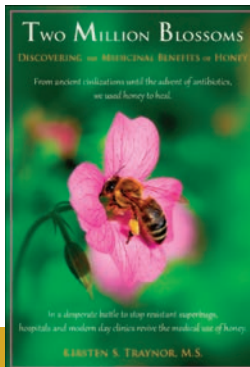

M00120 . . . \$20.55

Honey Bee Hobbyist

Discover whether honey beekeeping is right for you, and find out everything you need to know to keep and acquire bees in this updated guide. Honey Bee Hobbyist, 2nd Edition will help novice beekeepers fully understand this exciting pastime. Dr. Norman Gary, a world-renowned honey bee expert and enthusiast, counsels beginners on all things honeybee related. He takes readers from finding bees and housing them to collecting honey and using their produce for pleasure and possible profit. More than 100 fascinating color photographs and tips and tricks acquired over half a century of beekeeping. Softcover, 224 pages. Actual wt. 1.9375 lbs.



M000082 . . . \$17.45

Restocking fee of 35% for all pre-approved book returns

1-888-922-1293

Queen Rearing and Bee Breeding

World famous Professor Harry H. Laidlaw and his former student, Dr. Robert E. Page, Jr., worked together to write this excellent specialized book on queen rearing and bee breeding. Topics discussed run the gamut from the nuts and bolts of commercial queen rearing to more individualized queen rearing for the smaller queen producer. Queen biology and genetics are discussed, as well as more specialized topics such as instrumental insemination of queen bees. Softcover, 224 pages. Actual wt. 1.05 lbs.



M02312 . . . \$51.50

Applied Beekeeping in the United States

The beginner as well as the experienced professional will garner a hive full of information from Applied Beekeeping in the United States. Honeybee information has been compiled and published in book form in hopes that beekeepers in the United States and worldwide will benefit. There are many topics in this book not contained in more theoretical books and through 342 pages, supplemented by 246 full-color photographs, both the novice and experienced beekeeper will take away new knowledge. Hard cover, 342 pages. Actual wt. 3 lbs.

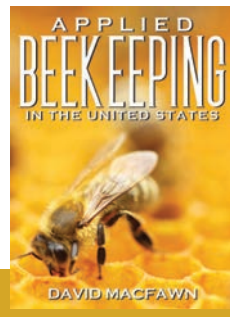

M01734 . . . \$45.50

Scientific Queen-Rearing

G.M. Doolittle first published this classic book on queen rearing in 1889. Mr. Doolittle spent over two decades researching and testing the ideas he outlined in his book. Now considered essential to the development of the modern queen rearing industry, the book describes how beekeepers are able to use the instincts of the hive to produce quality queens. Reprinted by Dr. Larry Connor's Wicwas Press. 101 pages, Softcover. Actual wt. 0.4 lbs.



M00097 . . . \$20.60

Queen Rearing Essentials 2nd Edition

Author Larry Connor has revised and updated his original version of this very practical book on rearing queen bees. The many beautiful color photos are immensely helpful. "This book is one-stop shopping for all you need to know to raise your own queens. A terrific update with all the latest information by the premier teacher of how to raise queens. Highly recommended!" — Dan O'Hanlon, President, West Virginia Queen Producers. Softcover, 160 pages. Actual wt. 0.7 lbs.

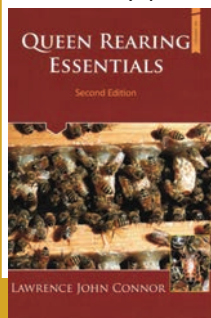

M019642 . . . \$23.70

Honey Bee Diseases and Pests 3rd Edition



This publication was prepared by the Canadian Association of Professional Apiculturists to assist beekeepers in preventing serious disease-related damage to their hives. Excellent color photos. Perfect for the hobbyist and a good addition for the experienced beekeeper. Softcover. 68 pages. Actual wt. 0.65 lbs.

M000131 . . . \$18.50

Increase Essentials - 2nd Edition

Author Dr. Lawrence Connor continues his Bee Essentials series with this excellent guide on how beekeepers can use nuclei to solve problems in the beeyards and use them to winter colonies and provide a reliable source of fresh bees, locally acclimatized queens, replacement hives and colonies for operational growth or sale. Second edition, softcover, 176 pages. Actual wt. 0.65 lbs.

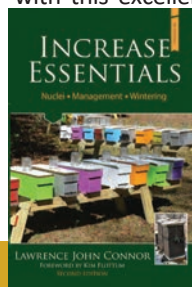

M00023 . . . \$25.75

Honey—Nature's Golden Healer

Author Gloria Havenhand believes that honey bees, the origin of many pharmaceutical drugs, have been forsaken and forgotten — to our cost. She now manages a number of honey bee colonies and runs Medibee, a bee product company.



With an increasing number of people interested in ditching drugs for natural alternatives to combat health problems from allergies to acne, this book is a timely look at how the beehive can help us look and feel better. Beautiful color photography. Softcover, 160 pages. Actual wt. 1.1 lbs.

M00032 . . . \$20.55

Bee Sex Essentials

Bee Culture/American Bee Journal writer Dr. Larry Connor reviews the latest and essential knowledge of drone and queen production, mating and genetics. He clearly and concisely shows how the sex life of bees directly impacts the fate of the colony and, in turn, the success of the beekeeper. He outlines a sample bee-breeding program for a sideline beekeeper with fewer than 100 colonies who wants to produce queens from survivor, locally-adapted and mite-resistant lines. Softcover, 152 pages. Actual wt. 0.8 lb.

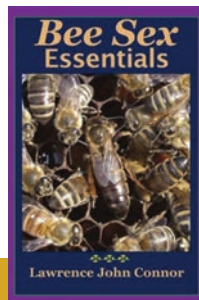

M00112 . . . \$25.75

Restocking fee of 35% for all pre-approved book returns

Honey from the Earth

The internationally acclaimed honeybee photographer Eric Tournet spent fifteen years traveling the world to capture the breathtaking diversity of bees and beekeeping traditions on six continents. This is by far the most stunning collection of bee photography ever produced, complete with insightful commentary from a dozen leading bee experts, including Dr. Tom Seeley, Dr. Jurgen Tautz, and Kirk Webster.



Hardcover, 352 pages, 300 full color photos. Actual wt. 6.2 lbs.

M01735 . . . \$66.90

Bee Club Basics

How to Start a Bee Club

What does a coffee pot have to do with beekeeping? Are you a beekeeper who wants to join forces with others? Are you a 'newbie' who wants to learn about beekeeping? Or maybe you just want to start a non-profit club. Charlotte Ekker Wiggins offers

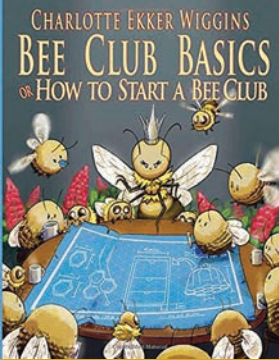

you pages and pages of advice of suggestions on how to meet new friends, come together for a common purpose and maybe even find 'family' with each other. AND, it's FUN! Softcover, 198 pages. Actual wt. 1.2 lbs.

M02319 . . . \$36.05

Following the Wild Bees —

The Craft and Science of Bee Hunting

Weaving informative discussions of bee biology with colorful anecdotes, personal insights, and beautiful photos, Thomas Seeley describes the history and science behind this lost pastime and how anyone can do it. The bee hunter's reward is a thrilling encounter with nature that challenges mind and body



while also giving insights into the remarkable behavior of honey bees living in the wild. Whether you're a bee enthusiast or just curious about the natural world, this book is the ideal companion for newcomers to bee hunting and a rare treat for armchair naturalists. Paperback, 184 pages. Actual wt. 0.7 lbs.

M00427P . . . \$16.95

Diagnosis & Treatment of Common Honey Bee Diseases 2nd Edition

Bee Informed Partnership's newly revised edition of "Diagnosis and Treatment of Common Honey Bee Diseases" manual is a 66 page spiral bound with laminated front and back cover sheets that includes detailed images and descriptions of the signs of diseases a beekeeper may encounter in their hives. This manual also goes into how to best treat or address the common diseases that honey bees face. Actual wt. 0.6125lbs.

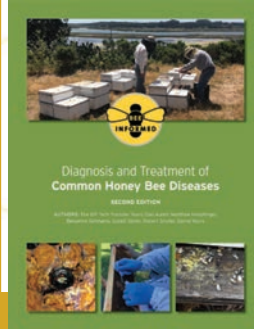

M02317 . . . \$36.05

The Bee Book

Bees are vital to the future of the planet, yet they are under threat and in decline. The Bee Book offers remarkable insights into their world and shows how we can support and enjoy them in our daily lives. Chapters include: An Amazing World of Bees; Attracting Bees; Caring for Bees; and Enjoying Bee Bounty. Many beautiful color photos and a very helpful section on incorporating honey and bee products in recipes, crafts, and home remedies. Hardcover, 221 pages. Actual wt. 2 lbs.



M00422 . . . \$25.75

Bee — Close-up Photography of the Bee

Photographer Rose-Lynn Fisher has compiled a wonderful portfolio of honey bee anatomy photographs that are truly amazing! These close-up photos and precise descriptions take the reader on a fantastic tour of the honey bee's anatomy that most of us have never imagined to exist. This is an important book for beekeepers in order for them to truly understand the marvelous creature they have come to know though their craft, 128 pages. Actual wt. 1 lb.



M00423 . . . \$23.70

A Year's Work in an Out-Apiary

One hundred years ago G.M. Doolittle developed honey production methods that eliminated swarming. This Centenary Edition includes all his original work plus added materials: A table of contents, an index, the 1897 interview written by E. R. Root, and study questions. Softcover, 114 pages. Actual wt. 0.5 lbs.

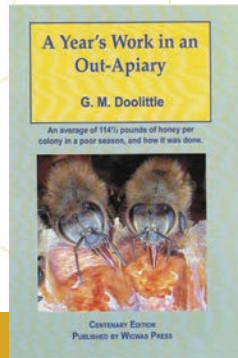

M00426 . . . \$20.60

Restocking fee of 35% for all pre-approved book returns

1-888-922-1293

DVD's

Natural Beekeeping by Ross Conrad - (DVD)

This DVD is a comprehensive survey of natural beekeeping, its principles and practices, aimed at both hobby and small-scale commercial apiculturists. In this filmed workshop, noted Vermont beekeeper Ross Conrad flips the script on traditional approaches by proposing a program of selective breeding and natural hive management. The video presents a comprehensive survey of natural beekeeping methods and challenges, including segments filmed in the field. It offers practical information that every aspiring beekeeper needs to know — everything from basic hive equipment to working with your bees to harvesting and processing honey. *Video time:* 193 minutes. Actual wt. 0.15 lbs.



M00049DVD . . . \$30.85

Natural Beekeeping - (DVD)

Organic, Non-Disruptive Apiarian Methods by

Jerry Dunbar

“Organic, Non-Disruptive Apiarian Methods” For more than 40 years Jerry Dunbar has been developing ways of working with honey bees in a manner that creates the least possible interference and encourages their health and future survival. *Video time:* 87 minutes. Actual wt. 0.2 lbs.



M01720 . . . \$30.85

Swarm plus - (DVD)

An Incredible, Up-Close Look at the Amazing Honeybee

This expertly done instructional DVD teaches the beekeeper about honey bee swarming and includes: Nine swarms, Feral colony, After the catch, Bee removal, Equipment, plus a Bonus video. The narrator demonstrates how to catch a variety of swarms in many different circumstances. A fun, instructional, and entertaining video. *Video time:* 58 minutes. Actual wt. 0.2 lbs.

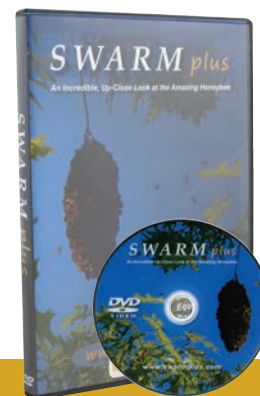

M00096 . . . \$24.70

More Than Honey - (DVD)

This informative DVD by Academy Award-nominated director Markus Imhoof tackles the vexing issue of why bees, worldwide, are diminishing in numbers. With the tenacity of a man out to solve a great mystery, he investigates this global phenomenon, from California to Switzerland, China and Australia. “Exquisite macro-photography of bees in flight and in their hives reveals a fascinating, complex world in crisis.” *Video time:* 91 minutes. Actual wt. 0.15 lbs.



M00107 . . . \$30.85

Restocking fee of 35% for all pre-approved book returns

www.dadant.com

Bees — Tales from the Hive (DVD)

Discover new found facts about the strange and complex life of bees in this in-depth documentary. It features up-close footage filmed with specially developed macro lenses. Witness the most intimate and spectacular portrayal of a working bee colony.

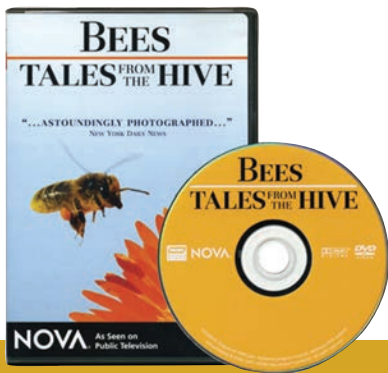

From a high-speed mid-air “wedding flight” to a close encounter with honey-loving bears, this Nova DVD exposes a bee colony’s secret world. Video time: 54 minutes. Actual wt. 0.15 lbs.

M00052 . . . \$36.05

Instrumental Insemination of Honeybee Queens (DVD)

Susan Cobey, world-renowned expert on honey bee queen insemination, shares her 25 years of experience in teaching this important technical skill that is vital to modern bee breeding. She also has 30 years of experience at single-handedly developing and maintaining a closed breeding program to produce her New World Carniolan bee stock. Her love of beekeeping and teaching shines through in this 30-minute DVD instructional program. Actual wt. 0.1 lbs.



M00047 . . . \$31.85

DVD’S AND/OR BOOKS

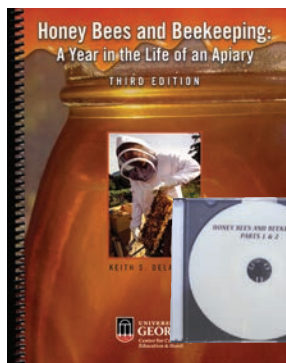

Honey Bees & Beekeeping — A Year in the Life of an Apiary

Honey Bees & Beekeeping by Keith S. Delaplane, Ph.D., is an eight episode video series and companion book designed to teach novices the

basics of beekeeping and to give more experienced beekeepers expanded knowledge. The videos trace the development of ten honey bee colonies from start-up through a complete year of management.

Book: *Honey Bees and Beekeeping: A Year in the Life of an Apiary* complements the videos. Softcover, 108 pages. Actual wt. 0.75 lbs.

M00099 Book only - \$20.55

DVD Series—All eight 30 minute episodes are presented on DVD. Actual wt. 0.1 lbs.

M00100DVD DVD series only - \$41.15

DVD Series—All eight 30 minute episodes are presented on DVD. Actual wt. 0.1 lbs.

M00100SETDVD \$59.70/set

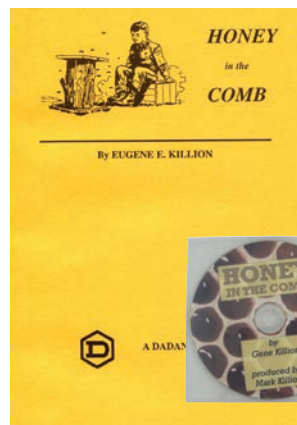

Honey In The Comb — Book and/or DVD

By Eugene E. Killion. Twelve comprehensive chapters cover every aspect of comb honey production in both round and square sections. 165 brand new photographs and equipment drawings, completely cross-indexed. softcover

in honey gold, 148 pages. Also, don’t miss the video by Gene Killion complementing his book of the same title. An excellent guide and aid for the novice and experienced beekeeper alike.

Book only Actual wt. 0.6 lbs.

M00006 - \$10.80

DVD only Actual wt. 0.1 lbs.

M001242DVD - \$20.55

DVD/Book Set Actual wt. 0.66 lbs.

M00006SET - \$30.40

Restocking fee of 35% for all pre-approved book returns

1-888-922-1293

CHILDREN'S BOOKS

Sweet Sophia Series

Follow Sweet Sophia as she travels through time, meets awesome people, and spreads the word about honey bees. Softcovers. (set of 3)
Actual wt. 0.7 lbs.



Set of 3 M00229 . . . \$28.35

SWEET SOPHIA GOES TO MOUNT VERNON

In this adventure Sweet Sophia meets George and Martha Washington plus shares her honey cherry turnover recipe! 58 pages.

SWEET SOPHIA MEETS CLEOPATRA

In this adventure Sweet Sophia meets Cleopatra and learns about bees and honey in ancient Egypt. She also shares her Sweet Honey Baklava recipe! 49 pages.

SWEET SOPHIA VISITS FLORENCE NIGHTINGALE

In this adventure Sweet Sophia visits Florence Nightingale in a London Hospital and learns about the wonderful work nurses do and how honey can be used in healing. She also shares her delicious Honey Oatmeal Cookie recipe at the end of the book! 53 pages.

Busy as a Bee—The Cat in the Hat knows a lot about that!

Join the Cat in the Hat on a buzzing adventure to find out how honey is made! This children's book comes complete with big two-sided crayons and easy-wipe-off pages, so you'll be able to draw with the cat over and over again! Hardcover, 12 pages. Actual wt. 1.05 lbs.



M01725 . . . \$10.30

Step into Reading — Show Me the Honey

This Step into Reading book has the Cat in the Hat telling kids where honey comes from as he takes you inside a beehive. Beautifully illustrated and written for children in grades 1-3. Softcover, 48 pages. Actual wt. 0.25 lbs.

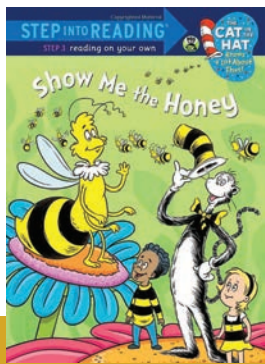

M01727 . . . \$4.10

Beehive

Have you ever seen a bee buzzing about and wondered what its life in and outside of a beehive is like? Now, you can find out! This charming, one-of-a-kind board book will educate, engage, and inspire young readers for hours on the important life and work of bees by providing a special look at life inside of a beehive. Actual wt. 1 lb.

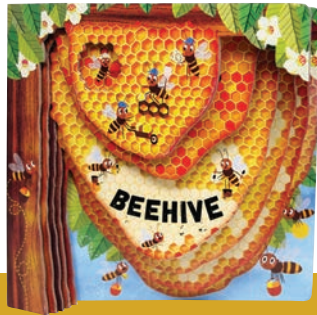

M01736 . . . \$9.99

The Secret Life of Bees

Follow Buzzwing the honeybee on a beautifully illustrated journey through the world of bees filled with amazing science and intriguing folklore. Did you know that bees love to dance? Or that they have an amazing sense of smell to help them find the best flowers? In The Secret Life of Bees, Buzzwing shares with you all the details of her life as a bee, in and out of the hive, starting with the day she was born. Hardcover, 48 pages. Actual wt. 1.56 lbs.



M01738 . . . \$19.95

Honey Bee Charli

Have you ever wondered about the life of a honey bee? Go along with Charli as she makes an exciting discovery while exploring out beyond the hive. Share her adventure-filled day and find out the important lesson she learns! Hardcover, 29 pages. Actual wt. 0.9 lbs.



M01719 . . . \$15.40

Grandpa's Hidden Gold Farm

You might not expect to discover gold on a farm, but Grandpa knows just where to find this hidden treasure — in his bee yard! Dig into Grandpa's Hidden Gold Farm for some sweet (and yummy) fun while learning about the beekeeping! Softcover, 26 pages. Actual wt. 0.25 lbs.



M00405 . . . \$8.25

Restocking fee of 35% for all pre-approved book returns

www.dadant.com

CHILDREN'S BOOKS

Andy the Ant Learns the Buzz On Bees

Learn the Buzz on Bees! This is a colorful children's book on bees written by Nancy Blackwell and illustrated by Charles Ettinger. Join Andy the Ant as he treks through an exciting adventure inside a beehive with his new friend, Beatrice the Bee. Activities in the back of the book include some tasty honey recipes for kids to try at home. Hardcover, 32 pages. Actual wt. 0.5 lbs.

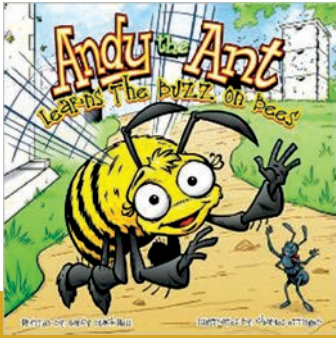

M00104 . . . \$20.60

Andy the Ant Have Bees Will Travel

A must have academic resource for the budding young scientists in your life. This informative book takes readers on a journey of the migratory bees. Andy the Ant will help them discover the importance of these special bees that are transported great distances to farms and orchards for pollination. It also shows how commercial beekeepers care for them. Actual wt. 0.5 lbs.

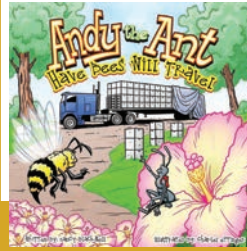

M01732 . . . \$16.45

Give Bees A Chance

Not sure whether to high-five bees or run away from them? Well, maybe you shouldn't high-five them, but you definitely don't have to run away from them. Give Bees a Chance is for anyone who doesn't quite appreciate how extra special and important bees are to the world, and even to humankind! Besides making yummy honey, they help plants grow fruits and vegetables. And most bees wouldn't hurt a fly (unless it was in self-defense!). Hardcover, 40 pages. Actual wt. 0.91 lbs.

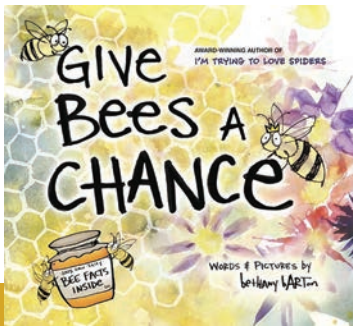

M00429 . . . \$17.50

Beauty and the Bees

Join Beauty in this farm-friendly adaptation of a timeless fairy tale that reminds us of how sweetness can be found in unexpected places. Softcover, 25 pages. Actual wt. 0.4 lbs.

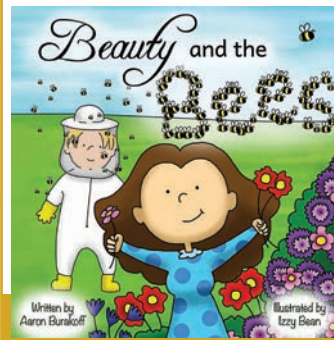

M00234 . . . \$7.95

In The Trees, Honey Bees

Children love to learn about honey bees and are fascinated by this industrious and ingenious social insect. Author Lori Mortensen and illustrator Cris Arbo have teamed up to create this award-winning children's book on the honey bees. Cris Arbo's wonderful color artwork is a real attention-getter and is sure to keep children glued to each page as they learn about the honey bee colony. Softcover, 30 pages with color artwork. Actual wt. 0.35 lbs.

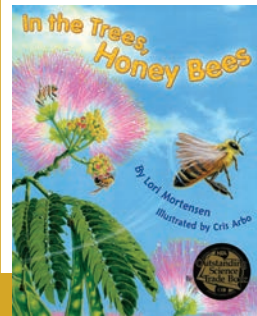

M00025 . . . \$9.20

The Berenstain Bears and the Missing Honey

Join the Berenstain Bears as they try to solve the case of the missing honey. You'll never guess who the honey thief is! This book is one of many from this excellent series written by Stan & Jan Berenstain for young readers. Softcover, 29 pages. Actual wt. 0.2 lbs.

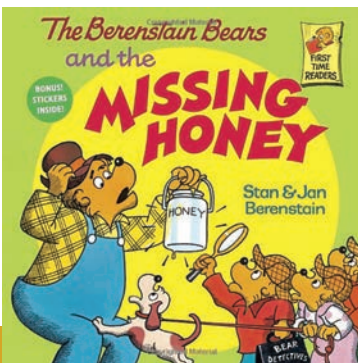

M01724 . . . \$5.15

The Berenstain Bears and The Big Honey Hunt

This beginning to read book by Stan and Jan Berenstain centers around Papa Bear as he tries to find some honey, but somehow things go wrong and he gets into lots of funny trouble with angry bees. Wonderfully illustrated. Hardcover, 63 pages. Actual wt. 0.55 lbs.



M01723 . . . \$9.25

Restocking fee of 35% for all pre-approved book returns

1-888-922-1293

NOTEPADS / POSTER

Bee Coloring Book

Ideal for the children. Attention getting coloring book. Children have fun coloring while they learn about bees and honey. Fun activities are also included.

24 pages.
Actual wt. 0.1 lbs.

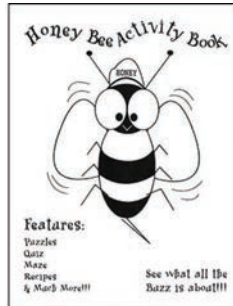

M000501

1-99 \$0.36
100-999 \$0.31
1000+ \$0.21

The Bee You See Coloring Book

Interesting Facts and more are explained in this fun coloring book that is designed to introduce you to honeybees and the art of beekeeping! Learn how to set up a hive or discover when honeybees first came to America.

Actual wt. 0.375 lbs.

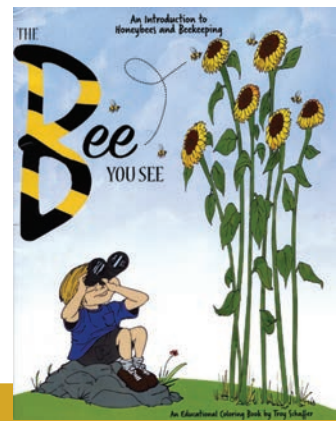

M00233 ... \$11.30

Hive Inspection Sheet Notepad



Hive Inspection Sheets to help record hive activity, requeening, treatments, feeding, honey storage, honey extraction, and the condition of the hive. Notepad is made up of 25 sheets with pre-drilled holes to fit into a 3-ring binder.

M01940 ... \$4.95

Honey Bee Life Cycle Chart

Great for classroom bee talks or beekeeping exhibits.

Poster size. 21 1/4" x 33"

Actual wt. 0.15 lbs.

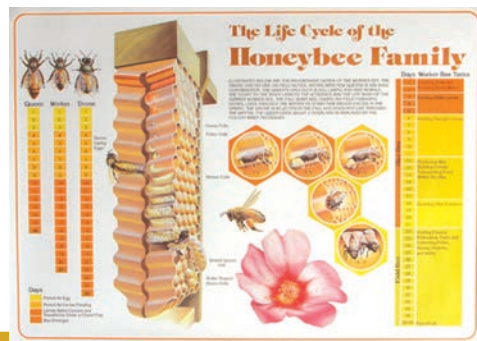

M00002 ... \$15.10

PUBLICATIONS

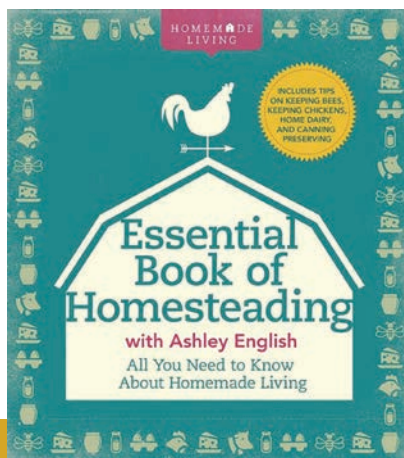

Essential Book of Homesteading

In barnyards and backyards, on rooftops and in alleyways, a movement is happening — the modern homesteading movement. Whether it's turning a lawn into a vegetable garden, getting a flock of chickens, or transforming cucumbers into pickles, people everywhere are taking charge of their own food supply. Ashley English, a major figure in the return to homesteading, gives newcomers her time-honored tips for successfully overseeing food production in their own homes. Totally updating material from her phenomenal homesteading books — Keeping Bees, Keeping Chickens, Canning & Preserving, and Home Dairy — this collection covers everything from preserving jams and jellies to whipping butter and keeping a hive of honeybees. Ashley provides entry points, troubleshooting tips, and inspiration for putting the food your family consumes back in your own hands. Hardcover, 168 pages. Actual wt. 2.42 lbs.

M00428 ... \$25.70

Restocking fee of 35% for all pre-approved book returns

www.dadant.com

RECIPE BOOKS

The NEW Honey Revolution — Restoring the Health of Future Generations

This revised and updated edition contains information from all the books in The Honey Revolution Series, PLUS new information



from dozens of new research studies documenting the amazing health benefits of consuming honey. In The New Honey Revolution you will discover how: Honey regulates blood sugar and is the sweetener of choice for diabetics. Honey can help you sleep better and recover faster. Honey reduces the risks for obesity, diabetes and heart disease, Softcover, 234 pages. Actual wt. 0.6 lbs.

M01986 . . . \$20.55

Joy With Honey 5th Edition

The 5th edition of this popular honey recipe book advertises “300 recipes you’ll love!” Doris Mech, retired beekeeper, teacher and creative cook, shares her favorite honey recipes



in this 5th edition. You will find Chewy Granola Bars, Blackberry Lemonade, Super Bowl Chili and Dreamy Chocolate Decadence as additions to this new edition. Spiral bound, softcover, 198 pages. Actual wt. 0.95 lbs.

M00121 . . . \$18.50

Honey, I’m Homemade Sweet Treats From the Beehive Across the Centuries and Around the World

Edited by May Berenbaum, professor of Entomology at the University of Illinois at Urbana-Champaign, this honey cookbook showcases a wealth of recipes for cookies, breads, pies, puddings, and cakes that feature honey as an essential ingredient. At the same time, Prof. Berenbaum details the fascinating history of honey harvesting and consumption around the world, explains the honey bee’s extraordinary capacity to

process nectar into concentrated sweetness, and marvels at honey’s diverse flavors and health benefits. Sales of the book will benefit the University of Illinois Pollinatorium — the first freestanding science outreach center in the nation devoted to flowering plants and their pollinators. Softcover, 163 pages. Actual wt. 0.75 lbs.



M00011 . . . \$22.60

Honey & Oats

Author Jennifer Katzinger describes her cookbook as “every-day favorites baked with whole grains and natural sweeteners.” Seventy-five mouth-watering recipes include Banana Buckwheat Pecan Muffins, Apple Pie, Sweet Potato Skillet Corn Bread, Honey Spice Cake and Chocolate Chip Cookies. Enjoy healthier versions of your favorite baked goods! Hardcover, 160 pages. Actual wt. 2 lbs.



M01728 . . . \$30.85

The Hibernation Diet

The Hibernation Diet works while you sleep! Authors Mike and Stuart McInnes have created a real media stir with their new book and have been the subjects of numerous newspaper, magazine, radio and TV interviews about their wonderful new diet. What’s the key to this diet working? — a spoonful of honey taken before bed every night! What could be easier than that! Softcover, 183 pages. Actual wt. 0.55 lbs.

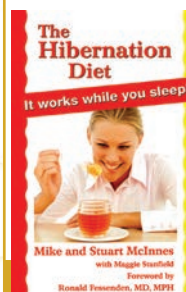

M00040 . . . \$15.40

The Fresh Honey Cookbook



84 recipes from a Beekeeper’s Kitchen. Highlighting a different varietal honey each month, beekeeper and chef Laurey Masterton offers honey-tasting tips and vibrant recipes that deliver amazing dishes, both savory and sweet. Softcover, 207 pages. Actual wt. 1.2 lbs.

M00105 . . . \$15.40

Cooking with My Honey

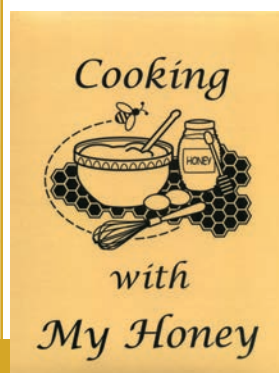

A collection of honey recipes by the East Texas Beekeepers Association, this new cookbook is handy to use with its spiral bound notebook style format. Sections cover Appetizers and Beverages; Soups and Salads; Vegetables and Side Dishes; Main Dishes, Breads and Rolls; Desserts; and Cookies and Candy. Hardcover, 116 pages. Actual wt. 1.2 lbs.

M00071 . . . \$20.55

Restocking fee of 35% for all pre-approved book returns

1-888-922-1293

CRAFT AND HOBBY BOOKS



Honey Bee Pancake Pan

Make breakfast extra special with whimsical, honey bee-motif pancakes that honor this humble, hardworking and highly revered pollinator. Each of the 7 pancakes will have a sweet, detailed image browned into it of a honeycomb, flower, hive or busy bee. Crafted of cast aluminum in the USA this sturdy pan features a stay cool handle plus PFOA-free nonstick to make turning pancakes and cleaning a breeze. Works with mixes or any favorite pancake recipe. 17¼" x 16" x 2¼" Actual wt. 1.4 lbs. ea.

M01170 . . . \$46.95

Honey Bees Cookie Stamps

- Cast Aluminum with Wooden Handles
- Makes 3 different styles - 3" Round Cookies
- Limited Lifetime Warranty by manufacturer
- Made in America
- Hand wash



Actual wt. 1.5 lbs.

M01162 . . . \$46.95

Beehive Cakelet Pan

- Cast Aluminum
- Interior Dimensions: 3 cups 2.78"L x 2.68"W x 2"H/ cavity
- Lifetime Warranty by manufacturer
- Made in America
- Hand wash



Actual wt. 1.25 lbs.

M01161 . . . \$46.95

Bee Hive Cake Pan

Our decorative cake pan does the work of hundreds of buzzing bees – with incredibly sweet results. Just fill both sides with batter, then bake. Adorned with bees, the two halves emerge ready to be pressed together with icing and decorated to form the 7" diam., 6" high cake. The cast-aluminum pan's nonstick finish ensures easy release. Hand-wash. 16" x 7¼" x 3½" high. Actual wt. 2.2 lbs.



M01160 . . . \$46.95

Honeycomb Cake Pan

Our exclusive heavy cast aluminum bakeware provides superior baking performance. Baked goods rise evenly, cook uniformly, and are finely detailed thanks to the excellent thermal conduction of the heavy walls. A special heat-reflective exterior and premium nonstick surface assures perfect results. Our unique pans are wonderful for bread, molded desserts and savory dishes, as well as cake. Hand wash. **Color may vary.** 12¼" x 11¼" x 2¼" Actual wt. 2.6 lbs.

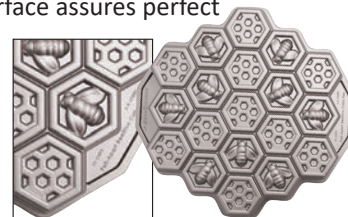

M01261 . . . \$46.95

Creating Candles

With over a hundred unique projects and more than a thousand beautiful photographs this book is a must-have guide for candle makers. Precise instructions accompany each photo. From designing a candle for special occasions to simply adding a decorative touch to any table, this book offers ideas using a wide variety of materials. It also includes creative variations and gift wrap suggestions for each candle. Softcover, 223 pages. Actual wt. 1.3 lbs.



M03002 . . . \$27.75

The Candlemaker's Companion

From wax to wick to wrapping, the magical glow of a handmade candle is now easier to create than ever before. Illustrated step by step instructions show you how to roll, pour, mold and dip candles. A great book for beginners and experienced candle-makers. Softcover. 199 pages. Actual wt. 0.85 lbs.

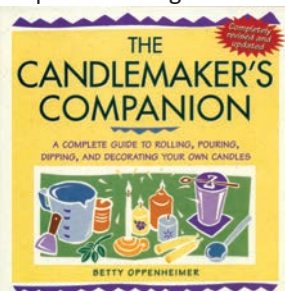

M00022 . . . \$21.60

Candle Making Basics

Step-by-step color photographs and descriptive detail make this book indispensable for beginners looking to create beautiful and functional scented candles on their very first try, and for experienced crafters who want to sharpen their skills. Precise instructions eliminate the guesswork that too often creeps into how-to books and help you avoid common mistakes. Softcover, 184 pages. Actual wt. 1.4 lbs.



M03003 . . . \$19.95

Restocking fee of 35% for all pre-approved book returns

www.dadant.com

CRAFT AND HOBBY BOOKS CONT.

The Soapmaker's Companion

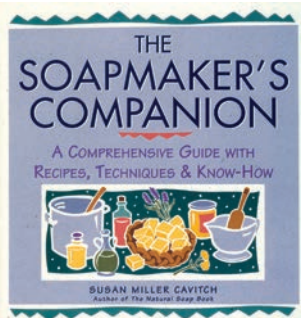

Susan Cavitch leads you through every step of the soap-making process with clear step by step instructions. She includes tips on how to start selling soaps. Softcover, 281 pages. Actual wt. 1.15 lbs.

M00021 . . . \$19.95

Melt & Mold Soap Crafting

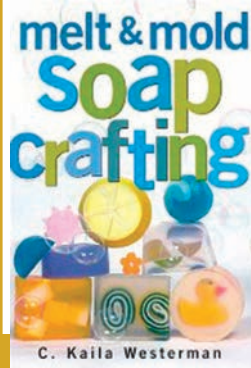

Soapmaking has never been this easy! The revolutionary melt-and-mold method is taking the craft world by storm. Beginning with a meltable glycerin base, crafters can create stunning specialty soaps in minutes, with no lye and no waiting. It's as easy as melt, pour, mold, and decorate. Softcover, 144 pages. Actual wt. 0.9 lbs.

M04003 . . . \$15.40

The Compleat Meadmaker



The title says it all. This is the book for the serious meadmaker. Authored by Ken Schramm, a well known expert on the subject, this book is 212 pages, softcover, and is published by the Association of Brewers. It is divided into four parts — Background, Process, Ingredients and Recipes. Actual wt. 1 lb.

M00036 . . . \$20.55

The Wildcrafted Cocktail

Meet the natural lovechild of the popular local-foods movement and craft cocktail scene. It's here to show you just how easy it is to make delicious, one-of-a-kind mixed drinks with common flowers, berries, roots, and leaves that you can find along roadsides or in your backyard. Foraging expert Ellen Zachos gets the party started with recipes for more than 50 garnishes, syrups, infusions, juices, and bitters, including Quick Pickled Daylily Buds, Rose Hip Syrup, and Chanterelle-infused Rum. You'll then incorporate your handcrafted components into 45 surprising and delightful cocktails. Paperback, 240 pages. Actual wt. 1.4 lbs.



M01739 . . . \$14.95

Making Wild Wines & Meads

125 unusual recipes using herbs, fruits, flowers and more to make a wide variety of wines and meads (honey wines). An excellent book for the home wine and mead maker. Authors Pattie Vargas and Rich Gulling are avid winemakers and will treat you to taste-tempting recipes for delicious fermented drinks such as Lemon-Thyme Methglin, Cherry Melomel and Cranberry Claret. Softcover, 176 pages. Actual wt. 0.65 lbs.

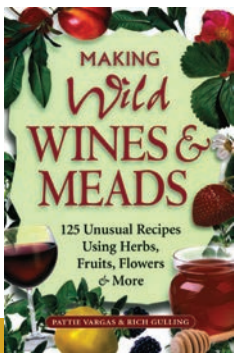

M00039 . . . \$17.45

Drink the Harvest— Making and Preserving Juices, Wines, Meads, Teas, and Ciders

Wouldn't you love to taste fresh from the garden or orchard peach juice and pear cider, rose hip tea, watermelon-mint syrup, dandelion wine and mixed berry mead? Skip the sugary commercial drinks and make these and many more fresh delicious beverages in your own kitchen. Whether you're looking for new ways to enjoy your garden's bounty or want to experiment with pure concoctions made from farmers' market finds, these recipes and techniques — including harvesting, canning, fermenting, and pasteurizing — will introduce you to a whole new world of garden goodness. Softcover, 223 pages. Actual wt. 1.25 lbs.



M00425 . . . \$19.50

Making Mead (Honey Wine)

An extremely popular book. Roger A. Morse provides the history and methods of making fermented drinks from honey and honey-fruit mixtures. Judging criteria included. Softcover, 128 pages. Actual wt. 0.4 lbs.

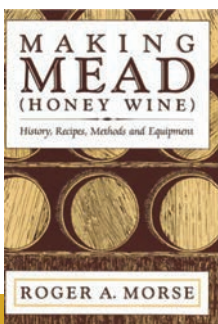

M00012 . . . \$20.60

Make Mead Like a Viking

As a homesteader, fermentation enthusiast, and self-described "Appalachian Yeti Viking" author Jereme Zimmerman embraces the traditional culture and rituals surrounding mead and will help others bring a sense of wildness, mysticism, and individuality to their home-crafted brews. In this accessible, easy-to-follow guide, readers will learn how to brew their own drinks such as sweet, semi-sweet, and dry meads; melomels, methglins, as well as Ethiopian t'ej, honey beers and grog. Softcover, 214 pages. Actual wt. 1 lb.



M02309 . . . \$25.70

Restocking fee of 35% for all pre-approved book returns

CREAMED HONEY AND LIP BALM KITS



Dadant Creamed Honey Kit

*** Increase Profits * Easy to do * Family Fun**

Creamed Honey Kit contains the following:

- 1 - Mixing Bucket with Gate
- 25 - 1 lb. Creamed Honey Containers
- 25 - Creamed Honey Labels
- 1 - Easy to Follow Instructions
- 1 - 1 lb. "STARTER" Seed
- 1 - Stainless Steel Mixer (used with 3/8" drill)
- 2 - 1 dram (1/16 oz.) Peach Flavoring Sample
- 2 - 1 dram (1/16 oz.) Strawberry Flavoring Sample
- 2 - 1 dram (1/16 oz.) Chocolate Flavoring Sample



M00506 Creamed Honey Kit
Actual wt. 7.58 lbs. **\$86.95**

Starter seed and flavorings are non-returnable



Accessories:

- M00506-02** 25 Labels
Actual wt. 0.1 lbs. **\$.49.95**
- M00203** Carton/25 1 lb. Containers
Actual wt. 1.54 lbs. **\$22.95**
- M01330** 1 lb. "STARTER" Seed
Actual wt. 1.1 lbs. **\$5.95**
- M01376** 4 oz. Peach Flavoring Each
Actual wt. 0.3 lbs. **\$16.95**
- M01377** 4 oz. Strawberry Flavoring Each
Actual wt. 0.3 lbs. **\$16.95**
- M01375** 4 oz. Chocolate Flavoring Each
Actual wt. 0.3 lbs. **\$16.95**
- M00506-01** Stainless Steel Mixer with Instructions
Actual wt. 0.52 lbs. **\$37.95**
- M00506-03** Creamed Honey Instructions
Actual wt. 0.3 lbs. **\$3.25**
- M00506-05** Creamed Honey Shrink Bands c/100
Actual wt. 0.2 lbs. **\$9.75**



M01930

Available at all branch locations

With ingredients such as natural beeswax, almond oil and shea butter you have a spa treatment for the lips. Kit includes 12 pots, 12 tubes, beeswax, 4 oz. almond oil, 4 oz. shea butter, four 1 dram bottles of gourmet flavoring oils (peppermint, pina colada, banana cream, black cherry), stir sticks, decorative labels and instructions. Makes enough for 24 containers.

M01930 Lip Balm Kit, Actual wt. 1.95 lbs. ea. **\$35.95**

Lip Balm Accessories

- M019301** — **Pots - 12 ct.** — Actual wt. 0.3 lbs. **\$8.95**
- M019302** — **Tubes - 12 ct.** — Actual wt. 0.15 lbs. **\$8.95**
- M019303** — **Shea Butter 4 oz.** — Actual wt. 0.3 lbs.s **\$7.50**
- M019304** — **Almond Oil Sweet 4 oz.** — Actual wt. 0.3 lbs. **\$6.95**
- M019305** — **Tangerine Oil - 1 Dram** — Actual wt. 0.05 lbs. **\$2.60**
- M019306** — **Peppermint Oil - 1 Dram** — Actual wt. 0.05 lbs. **\$2.60**
- M019307** — **Pineapple Oil - 1 Dram** — Actual wt. 0.05 lbs. **\$2.60**
- M019308** — **Tropical Punch Oil - 1 Dram** — Actual wt. 0.05 lbs. **\$2.60**
- M019309** — **Pina Colada Oil - 1 Dram** — Actual wt. 0.05 lbs. **\$2.60**
- M019310** — **Banana Cream Oil - 1 Dram** — Actual wt. 0.05 lbs. **\$2.60**
- M019311** — **Black Cherry Oil - 1 Dram** — Actual wt. 0.05 lbs. **\$2.60**

— NO SUBSTITUTIONS OR PARTIAL RETURNS ON KITS —

SOAP MAKING

Melt & Pour Beginners Kit

Make your own honey glycerine soap! Simply melt our honey based glycerine soap (contains 10% honey), add coloring and fragrance and pour into a mold. Kit includes 5 lb. honey glycerine soap, pouring pitcher, 2 soap fragrances, 2 soap dyes, 2 soap molds, thermometer, and soap making book "Melt & Mold Soap Crafting."

M04180 Melt & Pour Beginners Kit
Actual wt. 9 lbs. **\$125.95**



M04180

Standard Beginners Soap Making Kit

Everything you need, except lye, to make your own all natural soap. The kit includes a deluxe digital scale, thermometer, 2 soap molds, coconut, palm and olive oil, 2 soap fragrances, 2 soap dyes, and soap making book "The Soapmaker's Companion" book.

M04182 Standard Beginners Soap Making Kit
Actual wt. 13 lbs. **\$137.95**



M04182

The Soapmaker's Companion

Susan Cavitch leads you through every step of the soapmaking process with clear step by step instructions. She includes tips on how to start selling soaps. Softcover, 281 pages. Actual wt. 1.15 lbs.

M00021 **\$19.95**

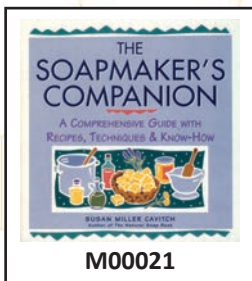

M00021

Soaper's/ Candlemaker's Scale

This compact digital scale is ideal for soap and candle making. Holds up to 9 lbs. with graduation precise to 1g/0.05 oz. and tare function. Actual wt. 0.9 lbs.

M04070 **\$39.95**



M04070

Melt & Mold Soap Crafting

Soapmaking has never been this easy! The revolutionary melt-and-mold method is taking the craft world by storm. Beginning with a meltable glycerin base, crafters can create stunning specialty soaps in minutes, with no lye and no waiting. It's as easy as melt, pour, mold, and decorate. Softcover, 144 pages. Actual wt. 0.9 lbs.

M04003 **\$15.40**

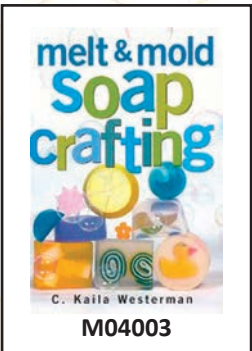

M04003

Soap/Candle Thermometer

An essential tool for soap and candle making. Stainless Steel with a shatterproof plastic lens. Stem inserts into the pocket holder's built in wrench and can be used as a handle. Actual wt. 0.05 lbs.

M03158 **\$18.10**



M03158

SOAP MAKING



M04067

Honey Glycerine Melt & Pour Soap

Anyone can become a soap crafter with this 10% honey glycerine soap. Just melt, add fragrance and color and mold. What a great and simple way to extend your product line, please your customers and friends and promote one of the many uses of honey! Comes in a wrapped 5 lb. bar.

M04067 Honey Glycerine
Actual wt. 5.1 lbs. . . . \$32.95



M04060

Soap Making Lye

Lye is getting more difficult to find. This high test lye is ideal for soap making. It comes in a 2 lb. can.

For pick-up only.

M04060 Soap Making Lye
Actual wt. 5 lbs. . . . \$15.95



M040651

Refined Shea Butter

Shea butter helps soften and protect skin from drying and aging. It is a great addition to lotions, balms, salves & soap. Actual wt. 1 lbs.

M040651 Refined Shea Butter
Actual wt. 1 lbs. . . . \$18.95



M040661

Cocoa Butter

Cocoa butter has a slight chocolate scent. Can be used as a moisturizer. Actual wt. 1.05 lbs.

M040661 Cocoa Butter
Actual wt. 1.05 lbs. . . \$20.95



M04064QT

Olive Oil

Olive oil has been used for dry and aging skin for thousands of years. The lather is thick but this is easily remedied by mixing with other oils.

M04064QT Olive Oil - Quart
Actual wt. 2.1 lbs. . . . \$17.95



M04063GL

M04063QT

Sweet Almond Oil

Almond oil is used as a main ingredient in massage oils, lotions, salves and balms. In soap it is used in smaller quantities to produce a mild soap with a good lather.

M04063GL Sweet Almond Oil - Gallon
Actual wt. 7.65 lbs. . . . \$48.95
M04063QT Sweet Almond Oil - Quart
Actual wt. 2.1 lbs. . . . \$18.95



M04061GL

M04061QT

Coconut and Palm-Base Oils

Most recipes call for Palm or Coconut oils. Coconut oil makes a hard bar of soap with a fluffy, creamy lather. Palm oil makes hard long lasting soap with small creamy bubbles.

M04061GL Coconut Oil - Gallon
Actual wt. 7.65 lbs. . . . \$37.95
M04061QT Coconut Oil - Quart
Actual wt. 2.1 lbs. . . . \$15.95
M04062GL Palm Oil - Gallon
Actual wt. 7.65 lbs. . . . \$37.95
M04062QT Palm Oil - Quart
Actual wt. 2.1 lbs. . . . \$15.95



M04062QT

M04062GL

SOAP MAKING



Soap Cutters

These soap cutters make a simple task of cutting soap into bars.

- M04050** Straight Cutter
Actual wt. 0.55 lbs. **\$13.50**
- M04051** Krinkle Cutter
Actual wt. 0.35 lbs. **\$13.50**



Wooden Soap Mold

One of the easiest ways to make soap is to use a loaf mold. This wooden mold will produce a loaf that is 3”H x 8”W x 12”L. Simply line the inside of the mold with wax paper or plastic wrap taking care to minimize creases and folds to avoid “blemishes” in the soap. Once the soap has set for 24 hours, unlatch the mold to remove the soap and then let the soap cure for another 24 hours before cutting.

- M04171** Wooden Soap Mold
Actual wt. 2.95 lbs. **\$31.95**

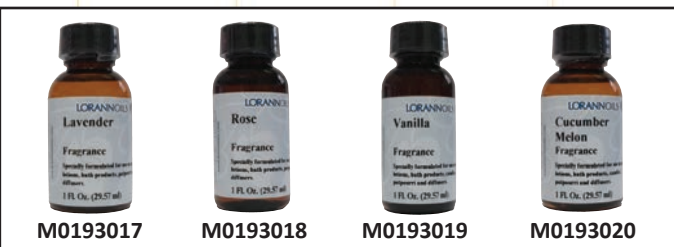

Liquid Fragrances for Soap

These highly concentrated liquid scents should be added to the soap base before pouring.

- Lavender **M0193017**
- Rose **M0193018**
- Vanilla **M0193019**
- Cucumber Melon . . **M0193020**

Liquid scents 1 oz. bottle

Actual wt. 0.1 lbs. **\$8.25**

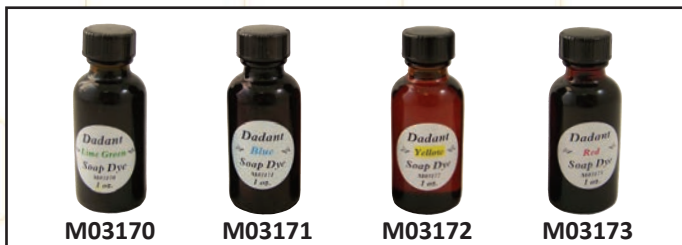

Soap Colorant

These are non-toxic liquid soap colorants. A little bit goes a long way.

- Green **M03170**
- Blue **M03171**
- Yellow **M03172**
- Red **M03173**

Soap Colorant 1 oz. bottle

Actual wt. 0.2 lbs. **\$9.95**

Bee and Blossoms Mold

The Bee and Blossom soap mold is a 3 cavity mold. A 3 oz. mold of a worker bee surrounded by many blossoms make this mold very attractive.

- M04155** Bee & Blossoms Mold
Actual wt. 0.15 lbs. **\$13.95**



Flying Bee Mold

The Flying Bee soap mold is a 4 cavity mold. Weighing in at 2.5 oz. this is sure to be a favorite at your local market and sales stand.

- M04156** Flying Bee Mold
Actual wt. 0.15 lbs. **\$13.95**



Sunflower Mold

The Sunflower soap mold is a 4 cavity mold. This mold will produce a bar approximately 4 ozs. in weight.

- M04157** Sunflower Mold
Actual wt. 0.15 lbs. **\$13.95**



SOAP MAKING



M04173

Queen Bee Soap Mold

This 4 cavity mold is sure to please the lady of the house. Design shows a Queen Honey Bee and the words "Queen Bee" are stated on the bar. Sure to be a hit. Great for gifts, farmers markets and in stores. Get yours today. Actual wt. 0.134 lbs.

M04173 Soap Bee Mold . . . \$13.95



M04158

Guest Bee Soap Mold

Pamper your guests with beautiful soap made from this mold. This 5 cavity mold features a bee surrounded by an attractive border. Each bar weighs about 1 3/4 ozs. and measures 2 1/4" diameter and 3/4" thick.

M04158 Guest Bee Soap Mold
Actual wt. 0.15 lbs. . **\$13.95**



M04152

Bee and Flower Mold

This 4 cavity mold shows a bee landing on a flower. Each bar weights about 4 ozs.

M04152 Bee and Flower Mold
Actual wt. 0.15 lbs. . **\$13.95**



M04168

Guest Tray Rectangular Mold

Welcome guests with small rectangular guest soaps. The mold produces 15 bars of about 1 1/2 ozs. each.

M04168 Guest Tray Rectangular Mold
Actual wt. 0.15 lbs. . **\$13.95**



M04154

Skep Mold

This is a beautiful 3 cavity skep mold. Each bar of soap weighs approximately 4 3/4 ozs. and measures 3 3/4" x 2 3/4" x 1 5/8".

M04154 Skep Mold
Actual wt. 0.15 lbs. . **\$13.95**



M04153

Bee & Honeycomb Mold

If you produce honey and beeswax soap this mold is for you. This is a 4 cavity mold showing a bee walking across a honeycomb. Each bar weighs approximately 3 1/2 ozs.

M04153 Bee & Honeycomb Mold
Actual wt. 0.15 lbs. . **\$13.95**



M04167

"Handmade" Tray Mold

A great way to advertise your efforts with this "Handmade" mold. The mold produces 8 bars about 4 ozs. each.

M04167 "Handmade" Tray Mold
Actual wt. 0.15 lbs. . **\$13.95**



M04159

Queen Bee Tray Soap Mold

A great mold for honey soap. The bee is located in the center of the mold with a beautiful floral border. The mold produces 9 bars weighing about 4 ozs. each.

M04159 Queen Bee Tray Soap Mold
Actual wt. 0.15 lbs. . **\$13.95**



M04165

Pine Cone Tray Mold

This popular 6 cavity mold will please friends and customers alike. Pine cone and needles are shown in great detail. Each bar weighs approximately 4 ozs.

M04165 Pine Cone Tray Mold
Actual wt. 0.15 lbs. . **\$13.95**



M04169

Goat Milk Tray Mold

This tray mold enables you to make 8 bars about 3 ozs. each.

M04169 Goat Milk Tray Mold
Actual wt. 0.15 lbs. . **\$13.95**



M04164

Beehive Tray Soap Mold

The mold produces one 2 lb. block of beehive soap. Simply cut into desired size to impress your guests and friends.

M04164 Beehive Tray Soap Mold
Actual wt. 0.15 lbs. **\$13.95**

CANDLE MAKING



M03200

Candlemaker Beginner's Kit

Here is all you need to begin making your own candles. The kit includes an aluminum melting and pouring pot, the book "Basic Candle Making", 3 lbs. ivory beeswax, 6 cup metal votive mold, 100 metal tea light cups, 100 pre-assembled votive light wicks, 100 pre-assembled tea light wicks, thermometer and 1 can of mold release spray. Actual wt. 18 lbs.

M03200 Candlemaker Beginner's Kit. \$131.95

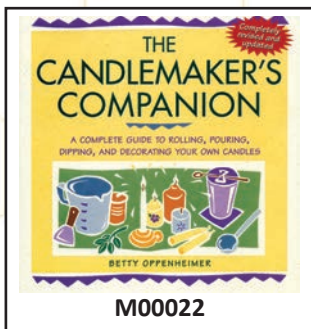

M00022

The Candlemaker's Companion

From wax to wick to wrapping, the magical glow of a handmade candle is now easier to create than ever before. Illustrated step by step instructions show you how to roll, pour, mold and dip candles. A great book for beginners and experienced candlemakers. Softcover, 199 pages. Actual wt. 0.85 lbs.

M00022 The Candlemaker's Companion. . \$21.60

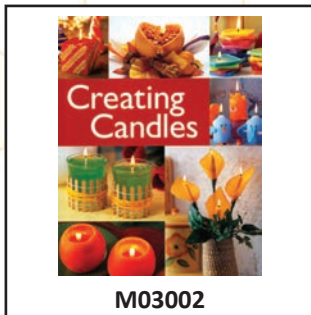

M03002

Creating Candles

With over a hundred unique projects and more than a thousand beautiful photographs this book is a must have guide for candle makers. Precise instructions accompany each photo. From designing a candle for special occasions to simply adding a decorative touch to any table, this book offers ideas using a wide variety of materials. It also includes creative variations and gift wrap suggestions for each candle. Softcover, 223 pages. Actual wt. 1.3 lbs..

M03002 Creating Candles. \$27.75



M03003

Candle Making Basics

Step-by-step color photographs and descriptive detail make this book indispensable for beginners looking to create beautiful and functional scented candles on their very first try, and for experienced crafters who want to sharpen their skills. Precise instructions eliminate the guesswork that too often creeps into how-to books and help you avoid common mistakes. Softcover, 184 pages. Actual wt. 1.4 lbs.

M03003 Candle Making Basics \$19.95

-- NO SUBSTITUTIONS OR PARTIAL RETURNS ON KITS --

How to Make Spiral Candles

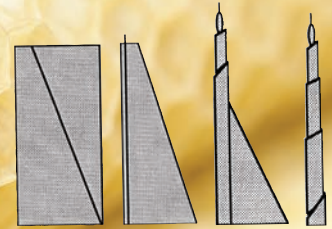

1. Cut sheet on the bias, making cut 2 inches from the corner of the sheet.
2. Lay 2/0 wick on straight edge of sheet and crimp edge of sheet over it.
3. With fingers spread over length of candle, start to roll wax making sure you roll tightly while keeping bottom end of candle even.

How to Make Pillar Candles

1. Use full sheet, place #2 wick across narrow end. Crimp edges to secure the wick.



2. Roll tightly, keeping the edges even



3. Finished candle



*See page 129
for Beeswax Honeycomb
Sheets and Candle Wicking*

CANDLE MAKING



M03121
3" x 6½" Pillar

M03120
2" x 3½" Pillar

Pillar Molds

These aluminum molds are ideal for beeswax pillars.

Use the bar listed below to center the wick.

(wick bar and wick sold separately)

M03120 2" x 3½" Pillar Mold
Actual wt. 0.1 lbs. . . . \$13.95

M03121 3" x 6½" Pillar Mold
Actual wt. 0.3 lbs. . . . \$16.95

M03114 Wick Bar
Actual wt. 0.05 lbs. . . . \$4.95

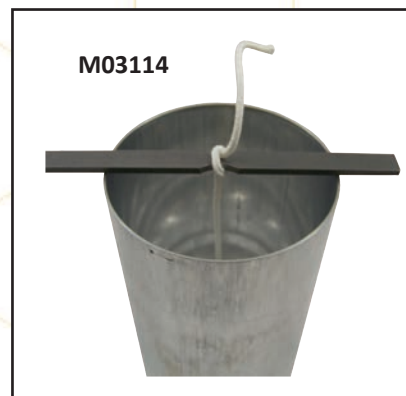

M03114

(mold, wick bar and wick all sold separately)

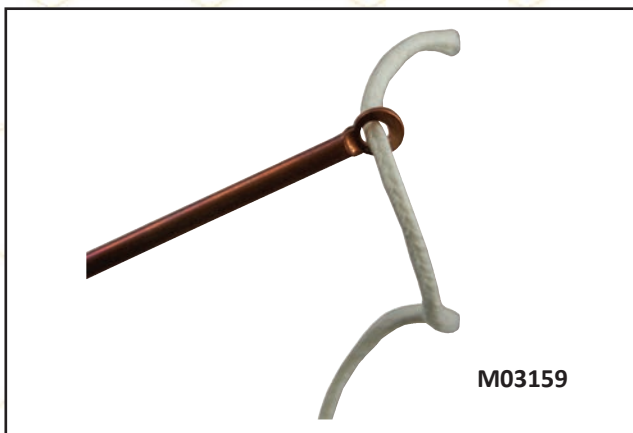

M03159

Wick Needle

This 18" copper wick needle makes threading the wick a snap. For use with polyurethane taper molds. Actual wt. 0.066 lbs.

M03159 Wick Needle \$8.95

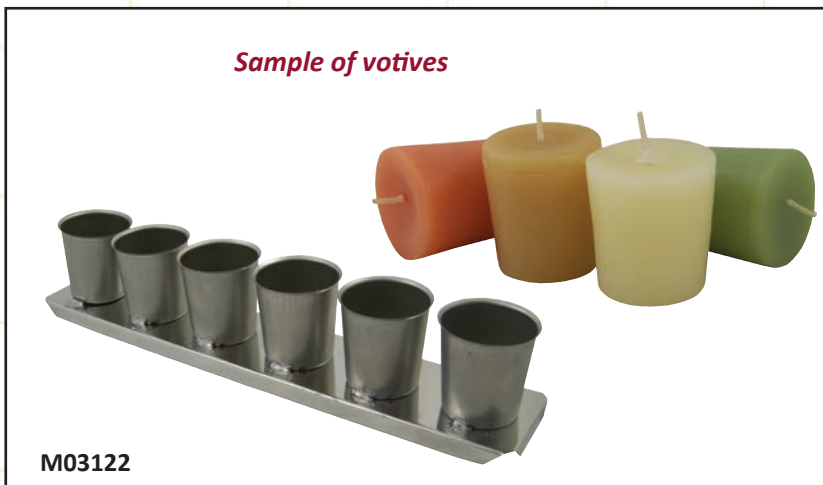

Sample of votives

M03122

Aluminum Votive Mold

This six cavity votive light mold will make an unlimited number of 15 hour votive candles. Spray silicone mold release prior to filling. For quicker release, place in freezer. Actual wt. 0.45 lbs.

M03122 Aluminum Votive Mold \$23.95



M03158

Soap/Candle Thermometer

An essential tool for soap and candle making. Stainless Steel with a shatterproof plastic lens. Stem inserts into the pocket holder's built-in wrench and can be used as a handle. Actual wt. 0.05 lbs.

M03158 Thermometer \$18.10

CANDLE MAKING

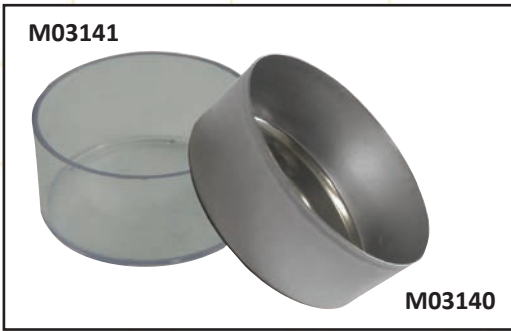

Tea Light Cups

These cups hold a ½ oz. of beeswax. Use plastic (polycarbonate) in open containers and metal in closed containers where generated heat might melt plastic.

M03140 metal, c/100
Actual wt. 0.15 lbs. \$16.50

M03141 plastic, c/100
Actual wt. 1 lb.. \$17.50



Seamless Melting Pot

This aluminum melting pot holds approximately two quarts of wax. It is ideal for filling candle and soap molds. Use with a water bath and never put on direct heat. Actual wt. 0.8 lbs.

M03100 Seamless Melting Pot \$24.95

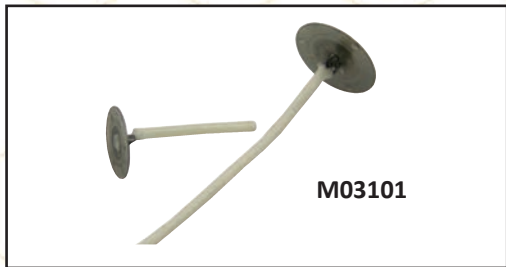

Pre-assembled Wicks

Save time with these pre-assembled wicks. Metal tab keeps wick upright while pouring wax.

M03101 Tea Light Wicks (qty. 100)
Actual wt. 0.1 lbs. \$9.95

M03102 Votive Light Wicks (qty. 100)
Actual wt. 0.2 lbs. \$9.95

Silicone Release Spray

Treating your mold before use will ensure that the details of the candle come out intact and are not lost by bits of wax sticking to the mold. 12 oz. container.

M03050 Silicone Release Spray, Actual wt. 1 lbs. \$13.95



Candle Dipping Rack and Vat

Simply fill the vat with melted wax and the dipper will allow you to make three pairs of dipped candles at a time. Vat holds up to 11½ lbs. of melted wax. Maximum candle height of 12" for dipping rack. Instructions available upon request.

Do Not Heat Wax in Dipping Vat.

M03123 Dipping Rack
Actual wt. 0.49 lbs. \$31.95

M03124 Dipping Vat 6" x 15"
Actual wt. 1.95 lbs. \$42.95



M03124
6" dia. x 15" high

BEESWAX HONEY COMB SHEETS

Create Your Own Candles!



- A Great Hobby
- Use Your Creative Talents
- A Great Money Maker
- Perfect for Fund-Raising

Note: Colors shown may not be an accurate sample of the color due to the difference in the beeswax used.

Sheet Size:
8" x 16³/₄"
Approx. 8 sheets per lb.

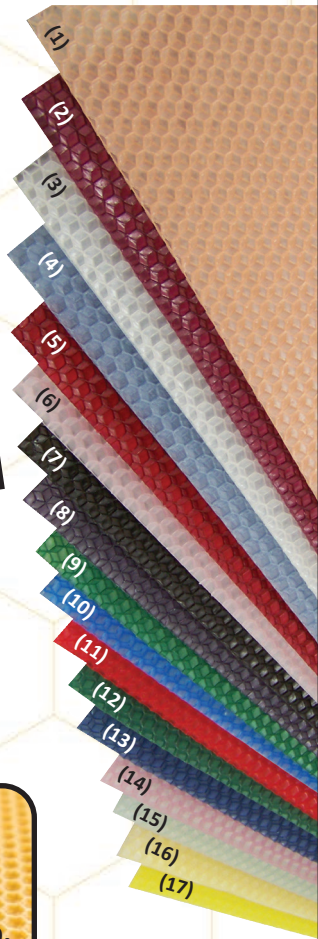

17 Beautiful Colors

Sheet Color	10 sheets	100 sheets
Apricot (1)	M43710	M43700
Burgundy (2)	M42410	M42400
Classic Ivory (3)	M40310	M40300
Cornflower Blue (4)	M43110	M43100
Cranberry (5)	M41610	M41600
Dusty Pink (6)	M43610	M43600
Ebony (7)	M43410	M43400
Egg Plant (8)	M41710	M41700
Forest Green (9)	M41410	M41400
French Blue (10)	M41010	M41000
Holiday Red (11)	M41210	M41200
Hunter Green (12)	M41310	M41300
Indigo (13)	M41910	M41900
Mauve (14)	M41810	M41800
Mint (15)	M44610	M44600
Natural (16)	M40110	M40100
Sunflower (17)	M40210	M40200

Candle Wicking

High quality 100% cotton wicking for all your candle needs. Wick sizes are for beeswax only. Packed in 30 ft. lengths. Actual wt. 0.05 lbs

<p>#2 Wicking — M03180 — best used on <i>Beeswax Tapers</i></p> <p>\$5.95</p>	<p>1/0 Square Braid — M03181 — best used on <i>Rolled Candles over 1" Wide</i></p> <p>\$5.95</p>
<p>2/0 Square Braid — M03182 — best used on <i>Rolled Candles under 1" Wide</i></p> <p>\$5.95</p>	<p>60 Ply — M03183 — best used on <i>Pillars 3" and over</i></p> <p>\$5.95</p>

Ctn/10 Sheets

\$26.95

Actual wt. 1.7 lbs

Ctn/100 Sheets

\$223.95

Actual wt. 14.2 lbs



W00102

White
1# Cake

Beeswax

Our white beeswax is selected from fine cappings wax and pressure filtered to produce a beautiful ivory color with the familiar beeswax scent. Our yellow refined beeswax varies in color from orange yellow to light brown. It has been filtered to remove impurities. Neither wax contains bleach.

Yellow Refined Beeswax

W00102 1# Cake Actual wt. 1 lb. \$10.45

White Refined Beeswax

W00202 1# Cake Actual wt. 1lb. \$10.45

Call for Quantity Breaks

www.dadant.com

GREAT IDEAS FOR GIFTS

HONEY SIGNS



Plastic Corrugated Honey Sign

(2 sided)

Durable waterproof sign to sell your honey. Black text on orange. Sign measures 18" x 24".

M00791
Actual wt. 0.45 lbs.
\$10.95



Plastic Corrugated Caution Sign

Durable waterproof sign to help keep unwanted guests away. Sign measures 18" x 24".

M01962
Actual wt. 0.44 lbs.
\$10.95



Metal Honey Sign

Attract people to your honey. Black text on bright yellow 18" x 24" *Local HONEY For Sale* sign.

M01963
Actual wt. 1.55 lbs. ea.
\$35.95

Metal Stand

Display Plastic Corrugated Honey Signs in your yard. Stake can be inserted into the ground up to 8" to display your sign at a minimum height of 12" (from ground to bottom of sign).

M01968
Actual wt. 0.775 lbs.
\$11.95

Only for use with plastic corrugated honey signs.



Hexagon Worker Bee Signs

Our hexagon worker bee signs are sure to please any honeybee enthusiast. 14" wide x 12.25" tall. Post them in your extracting room or bee yard and let those around you know worker bees are in the area.

M01991 Bees at Work,
Actual wt. 0.3 lbs. ea. \$23.95

M01992 Worker Bees Only,
Actual wt. 0.3 lbs. ea. \$23.95

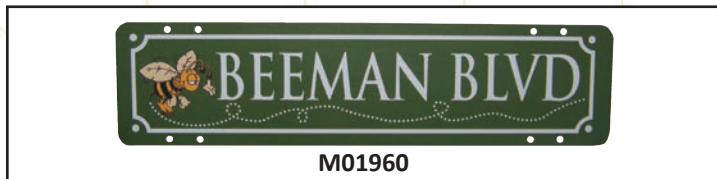

Metal Street Signs

Our Beeman Blvd and Queens Hwy signs are made like an official street sign. Can be displayed inside or out. Dimensions are 6" x 24".

M01960 Beeman Blvd, Actual wt. 0.5 lbs. ea. \$23.95
M01961 Queens Hwy, Actual wt. 0.5 lbs. ea. \$23.95

GREAT IDEAS FOR GIFTS

Mead Making Kit



This one gallon mead making kit has all the equipment you need to make a great honey wine. Kit comes with one gallon carboy, double bubble air lock, rubber bung, funnel, racking hose, yeast energizer, wine yeast and instructions. This kit would make a great gift for your favorite mead loving beekeeper. Actual wt. 3.425 lbs.

M01407 Mead Making Kit \$57.95

**FOR ALL YOUR WINE and MEAD MAKING
NEEDS PLEASE VISIT OUR WEBSITE AT:**

<https://www.dadant.com/catalog/crafts/wine-mead-making>



Honey Bee Tree Game

The Honey Bee Tree Game is a skill and action game for ages 3 and up. Skillfully remove the leaves without waking the bees. 2-4 players. Actual wt. 1.4 lbs.

GSBETREE \$21.95



Gift Bags

Proudly display your honey in these honey bee designed gift bags. Made from jute with a clear display window and honey bee designs. Choose either the single or triple, designed to hold either one or three 1 lb. Queenline style or Classic jars.

GSGIFTBAG1 Actual wt. 0.1 lbs. \$3.95 ea.

GSGIFTBAG3 Actual wt. 0.3 lbs. \$4.95 ea.

CALL FOR QUANTITY PRICING

Old Beekeeper Craft

Perfect gift for your beekeepers desk or shelf. The Old Beekeeper Craft will look great where ever you put it. Actual wt. 0.4 lbs. ea.

M01279 \$6.95



**Honey not
included**

GS050

Honey Box

This honey bee decorated box holds 3 – 1 lb. jars of honey (honey not included). Show off your spring, summer, and fall honey in this nice corrugated box. Makes for a great gift and perfect for farmers markets. Actual wt. 0.2 lbs.

GS050 Honey Box \$4.25

Bee Fan

This cute honeybee desk fan will keep you cool while working at the computer. Comes with soft flexible blades and plugs directly into the USB port of your computer's hard drive. Actual wt. 0.35 lbs.

GS040 \$15.95

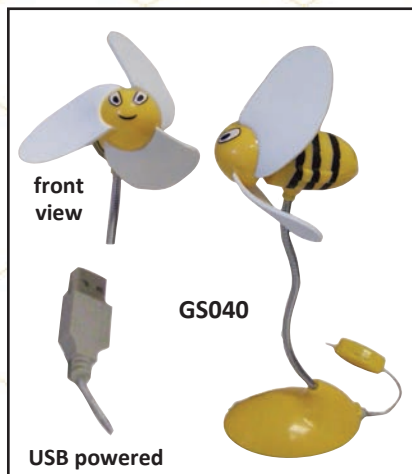

front
view

GS040

USB powered

GREAT IDEAS FOR GIFTS

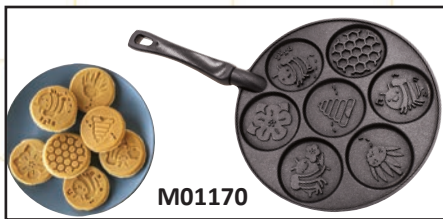

M01170

Honey Bee Pancake Pan

Make breakfast extra special with whimsical, honey bee-motif pancakes that honor this humble, hardworking and highly revered pollinator. Each of the 7 pancakes will have a sweet, detailed image browned into it of a honeycomb, flower, hive or busy bee. Crafted of cast aluminum in the USA this sturdy pan features a stay cool handle plus PFOA-free nonstick to make turning pancakes and cleaning a breeze. Works with mixes or any favorite pancake recipe. 17¼" x 16" x 2¼"

M01170 Honey Bee Pancake Pan, Actual wt. 1.4 lbs. ea. \$46.95



M01160

Bee Hive Cake Pan

Our decorative cake pan does the work of hundreds of buzzing bees – with incredibly sweet results. Just fill both sides with batter, then bake. Adorned with bees, the two halves emerge ready to be pressed together with icing and decorated to form the 7" diam., 6" high cake. The cast-aluminum pan's nonstick finish ensures easy release. Hand-wash. 16" x 7¼" x 3½" high.

M01160 Bee Hive Cake Pan, Actual wt. 2.2 lbs. ea. \$46.95



M01161

Beehive Cakelet Pan

- Cast Aluminum
- Interior Dimensions: 3 cups 2.78"L x 2.68"W x 2"H/ cavity
- Lifetime Warranty by manufacturer
- Made in America
- Hand wash

M01161 Beehive Cakelet Pan, Actual wt. 1.25 lbs. ea. \$46.95



M01162

Honey Bees Cookie Stamps

- Cast Aluminum with Wooden Handles
- Makes 3 different styles - 3" Round Cookies
- Limited Lifetime Warranty by manufacturer
- Made in America
- Hand wash

M01162 Honey Bees Cookie Stamps, Actual wt. 1.5 lbs. ea. \$46.95

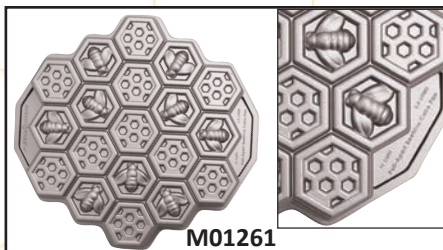

M01261

Honeycomb Pull-Apart Cake Pan

Our exclusive heavy cast aluminum bakeware provides superior baking performance. Baked goods rise evenly, cook uniformly, and are finely detailed thanks to the excellent thermal conduction of the heavy walls. A special heat-reflective exterior and premium nonstick surface assures perfect results. Our unique pans are wonderful for bread, molded desserts and savory dishes, as well as cake. Color may vary. Hand wash. 12¼" x 11¾" x 2¼"

M01261 Honeycomb Cake pan, Actual wt. 2.6 lbs. ea. \$46.95



GSBQSAUCE Original

GSBQSAUCESS Sweet and Spicy

BBQ Sauce Sue Bee Honey

Sue Bee has done it again. They have created another premium barbeque sauce using pure natural honey as the main ingredient. With two exciting flavors, Original and Sweet and Spicy style, you will want to buy both. Each bottle is 14 ozs. Actual wt. 1.3 lbs. **NON-RETURNABLE**

GSBQSAUCE Original \$6.99 ea.

GSBQSAUCESS Sweet & Spicy \$6.99 ea.

Honey Candy An Old Fashioned Favorite

Back and better than ever. This old fashioned honey-filled goodness is again available in a variety of assorted flavors. Enjoy lemon, strawberry, orange, sour apple, grape or double honey candies. All individually wrapped for easy handling. Approx. 72 pieces per pound. Actual wt. 1.05 lbs. **NON-RETURNABLE** Ship wt. add 1 lb. to quantity ordered.

ASSORTED Approx. 72 pieces per lb. - 29 lbs. per case - Actual wt. 33.55 lbs.

M02205LB One pound candy \$8.95 per lb.

M02205CS 1-9 cases. \$129.95 per case

10+ cases \$126.95 per case



M02205LB

GREAT IDEAS FOR GIFTS



Honey Straws

Our Clover Honey straws are produced in the USA. Pack comes with plastic wrapped straws. Great for Honey Stands and farmers markets. Packs of 50 & 500 Available.

The Chocolate Mint Honey Straws are produced in the USA. They are a perfect blend of Chocolate, honey & mint. Packs of 50 & 500 Available.

NON-RETURNABLE

Clover Honey Straws,

M010850 50 count, Actual wt. 0.65 lbs. ea. . . . \$8.99

M0108500 500 count, Actual wt. 10 lbs. ea. . . \$59.95

Chocolate Mint Honey Straws,

M010950 50 count, Actual wt. 0.65 lbs. ea. . . . \$8.99

M0109500 500 count, Actual wt. 10 lbs. ea. . . \$59.95



Dadant Hats Assorted Colors

\$17.95 each

Embroidered hat with adjustable strap.

Available in 18 color combinations.

Actual wt. 0.2 lbs.



Back closure

M012122
Cardinal Red/White

M012123
Charcoal Gray/Black

M012124
Charcoal Gray/Columbia Blue

M012125
Charcoal Gray/Neon Green

M012126
Charcoal Gray/Neon Orange

M0121216
Black/Tan

M012127
Charcoal Gray/Neon Pink

M012128
Heather Gray/Black

M012121
Brown/Khaki Beige

M012129
Heather Gray/Navy

M0121210
Heather Gray/Royal Blue

M0121217
Red/White

M0121211
Khaki Beige/Burgundy Red

M0121212
Maroon Red/White

M0121213
Navy Blue/Orange

M0121214
Red/Black

M0121215
Royal Blue/White

Bee Key-pers



These keychains are perfect for the bee-keeper or gardener in your family. Also works great on luggage when trying to identify one's suitcase at the airport.

M01707 Large bees/black trim

M01708 Large bees/blue trim

M01709 Hot Pink

M01710 Black trim

M01711 Gold trim

M01713 Pink flowers/gold trim

M01714 Medium bees/green trim

M01715 Tiny bees/blue trim

M01716 Polka dot/black trim

M01717 Honey pots/orange trim

M01718 Honey pots/green trim

\$10.25 ea.

Actual wt. 0.05 lbs.

Dadant
FAMILY OWNED SINCE 1863

GIFT CARDS
The perfect gift for anyone!

Redeemable at all branch locations and online at
www.dadant.com/catalog

Stops the Sting
M00137

Stops the Sting
"Stops the Sting" does just that. If you have been stung, smear a small amount of "Stops the Sting" on the affected area for aid in relief of the pain.

Actual wt. 0.05 lbs., ea.
M00137 \$9.95

GSDECALS

Family Beekeepers Decal
Show off your status as a beekeeper as you drive around town, apply them to your beekeeping binder or decorate your apiary office with these durable vinyl beekeeper family decals. Actual wt. 0.9 lbs.

GSDECALS \$17.95

Apis M.
GS014

Apis M. Magnet
Show your support for the honey bee with this Apis M magnet. Perfect for your refrigerator, or car bumper. Actual wt. 0.05 lbs.
GS014 \$4.95

Assembled
M01977

TOOLS and FRAMES NOT INCLUDED

Multi-Purpose Tool Box
This multi-purpose tool box will carry most everything you need to take to the bee yard. Carry extra frames, pollen sub patties, tools and medications. This box can come in handy on swarm calls as well. Uses 9 1/8" frames - **not included**.

M01977 Tool Box, Actual wt. 13.8 lbs. \$79.95

M001431

Jet Force — Bee, Wasp & Hornet Killer
Jet Force is great for getting rid of those unwanted pests. (Not for use around honey bees.) Provides a 12 ft. jet stream of insecticide that kills bees, wasps, yellow jackets, and hornets. Kills at once on contact and residue kills within 24 hours. Actual wt. 1.2 lbs. ea.
M001431 \$11.95
12 & up \$11.40

Assembled
FRAMES NOT INCLUDED
GS4006

5-Frame Observation Hive
This 5-frame nuc observation hive is perfect for educating both adults and children alike. Pull a frame from the nuc and place in the observation hive. Be sure to find the queen and place her in the upper section. The removed frame can be replaced with a division board feeder full of sugar syrup to feed the bees while caged. When not using the observation window move the frame back down below and let the bees fly freely until needed again. Uses 9 1/8" frames - **not included**.

GS4006 5-Frame Observation Hive
Actual wt. 21.1 lbs. \$199.95

B52901
Assembled

Top Bar Hive
For the natural beekeepers here is the ultimate in top bar hive. This top bar hive comes with 26 frames that can be divided into two separate hives with the follower board and screened bottom. Comes fully assembled except for the legs.

Ships freight.

- Fully assembled except for the legs
- Screened bottom board
- Follower board
- 26 top bars

B52901 Top bar hive, Actual wt. 55 lbs* . . . \$311.70
* See page 136

COMPANY POLICY

FREE SHIPPING

Free Shipping applies to most orders placed from this catalog and our online store for orders over \$150 prior to tax and other handling charges. Items will be sent regular ground by the carrier of our choice within the lower 48 states. Items marked with the symbol  are excluded from the free shipping offer. The items included/excluded from free shipping are subject to change without notice. Due to rising cost for shipping, backorders are shipped and billed separately from your original order. Customers will be responsible for the additional shipping charges on all back orders. If you wish to have your order held for the back ordered item please put that in the notes section online or advise the customer service rep when phoning in an order. AK and HI are excluded.

SHIPPING RATES

Customer pays all freight cost unless otherwise stated or agreed upon. Large orders over 200 lbs will be reviewed to determine if the order will go regular ground or by freight. If we determine the order is too large to go by ground, we will compare different freight lines to get the best possible rate for you. Next day, 2-day, & 3-day shipments will be available at expedited rates. Freight is F.O.B Shipping point meaning customer take full responsibility upon leaving Dadant & Sons shipping point. **NOT GUARANTEED, NO REFUND**

ADDITIONAL CHARGES

Rural Area: \$2.75	Delivery Acknowledgement: \$3.00
Extended Residential: \$3.50	Call Tag Required: \$9.00
Address Corrections: \$14.00	Handling Fee per shipment: \$2.00

Shipping rates may increase at any time due to rising shipping cost and surcharges

EXPORT ORDERS

Orders for export may include shipping, special packaging and documentation fees at the customer's expense. We accept Visa, MasterCard, Discover, American Express & checks drawn from a US Bank in US currency. For large container orders, we accept a bank wire transfer to our bank account or a letter of credit. All bank wire transfer cost and exchange rates are the responsibility of the customer.

PAYMENT METHODS

We accept Visa, MasterCard, Discover, American Express, check drawn on US bank account, wire transfer, money order & cash.

OVERPAYMENTS

May be refunded or credited to customers account.

RETURNED CHECK:

All returned checks will have a \$25.00 service fee

PICKUP ORDERS

All pickup orders can be picked up at the local branch where the order was placed at. Pickup times can vary by branch. In most cases, if you contact your local branch ahead of time, we will have your order ready for pickup when you arrive.

BACKORDERS

Backorders are shipped & billed separately from original order. Customers will be responsible for the additional charges on all back orders. Back orders can be dropped from original order at customer's request.

SPECIAL ORDERS

A 50% deposit must accompany all special orders. Some special orders may be subject to a cancellation charge. Remaining balance due prior to shipping.

WARRANTY

Dadant & Sons warrants its equipment to be free of defects in material and workmanship. If within 30 days of purchase you feel an item to be defective, please call for return authorization # and shipment instructions for the return. We will refund your purchase price along with all transportation charges. This warranty does not cover

any damage to equipment arising from alteration, abuse, or use of product for other than its intended purpose. We reject all implied and expressed warranties.

LIABILITY

Because conditions of use are beyond our control, we make no warranty or representation, express or implied, except that all products conform to the description provided by the manufacturer on sales literature or product labels. Our liability is limited to the purchase price paid. Glass containers ship at your own risk.

PRODUCT SUITABILITY

Many States & localities have codes and regulations governing sales, construction, installation, and or use of products for certain purposes. While we attempt to assure that our products comply with such codes, we cannot guarantee compliance in every situation. We cannot be responsible for how the product is installed or used. Before you purchase and use a product, please review both the product application and local codes and regulations. Be sure that the product, its installation, and its use will comply with them.

DAMAGED FREIGHT

All merchandise is shipped "F.O.B. Shipping Point". All products become your responsibility as soon as it leaves Dadant & Sons Inc. The freight carrier is responsible for complete and safe delivery or your merchandise. Inspect the packaging and merchandise upon arrival. If the freight carrier fails to deliver your merchandise in good condition, it is your responsibility to note this to the driver upon delivery. Also contact us immediately so we can make a claim with the carrier on your behalf.

ORDER DISCREPANCIES

Check all orders immediately upon receipt and contact us within 7 business days on any discrepancies/damage or we cannot be responsible for errors.

RETURNED MERCHANDISE

If you want to return an item, please call 1-888-922-1293 or contact the local branch where the item was purchased from. 1) Item must be in original carton and in good condition, 2) Returned within 30 days of receipt. 3) Must be returned to location of original purchase. 4) Original receipt required. 5) Charges will be applied to the unit reshipped to you with credit applied back to your method of payment upon receipt of original item.

LIMITATIONS

1) In most cases a 15% restocking fee will be charged. 2) To insure purity, we cannot exchange or offer refunds on beeswax or beeswax foundation. 3) We cannot accept returns on medications, containers, or bee feeds. 4) Restocking fee of 35% for all pre-approved book returns. Exception: If we made an error, we will give a full refund and pay the freight both ways.

STATE SALES TAX

We are required to collect sales tax where applicable by law.

HOLIDAY CLOSING

In addition to recognized national holidays, we will be closed the day after Thanksgiving.

CLOSING FOR INVENTORY

We will be closed on **August 29 & 30, 2024** for our annual inventory.

CATALOG ERRORS

We are not responsible for typographical or photographic errors that may appear in any Dadant material. We reserve the right to make adjustments or corrections due to changing market conditions, product discontinuations, or typographical or photographic errors in products.

Hours:

Contact your local Dadant Branch for hours of operation. Each branch may vary. (See page 137)

To Place Your Order

For maximum savings on freight, refer to the map on the back cover and select the Dadant branch closest to you.

PHONE

By Phone: Dial the Toll Free Order Number for the Dadant Branch nearest you for better customer service when placing your order. *(For faster service, please have your order written down and your credit card number ready. Also, please know your **Dadant Customer Number** (located above your address label on the back cover) to speed up the order process.*

FAX

By Fax: Make out your order with item numbers and quantity and fax the completed order to your nearest Dadant branch.

MAIL

By Mail: Make out your order with item numbers and quantity and mail the completed order to your nearest Dadant branch.

ONLINE

By Internet: Check out our website: www.dadant.com.
Online ordering available at www.dadant.com/catalog.

We Ship By:

National/regional carrier and Truck Freight. Special priority shipping options available at higher costs.

Please be sure to provide the correct shipping address with your order. Charges for incorrect addresses will be forwarded to your bill. Additional charges for rural delivery will be added to your invoice.

WE CANNOT SHIP TO **P.O. BOXES**. PLEASE PROVIDE A PHYSICAL ADDRESS TO SHIP TO.

Check website or call for truck freight quotes.

If you provide a valid email address, we will send tracking information for your order if the carrier provides this service. Depending on the carrier, shipments may not be able to be traced until 30 days after shipment has been made, which may be unfeasible due to the seasonal nature of our business. We will be happy to provide a quote with any alternate carriers available to us if you request it with your order.

We reserve the right to bill you for additional shipping charges. We reserve the right to ship it from a different branch to complete your order in a timely manner.

** Dimensional weight may be used rather than actual weight. Dimensional weight is a formula used by package delivery companies to determine a billing weight based on density. Some items may show the billing weight rather than the actual weight.*

Dimensional rates are calculated on **every shipment**.

DADANT DEALERS

Hargraves (Loxley, AL)
Bemis Tree Farm (Little Rock, AR)
Chick N Bees (Los Gatos, CA)
LA Honey Co (Los Angeles, CA)
OC Bee Supply (Fullerton, CA)
Forester Farm (Rising Fawn, CA)
Sacramento Beekeeping Supplies (Sacramento, CA)
Rocky Mtn Bee Supply (Colorado Springs, CO)
Greenview Aquaponics (Cape Coral, FL)
Joseph Bundrick (Crestview, FL)
Monarda Apiaries (Ft. Pierce, FL)
The Bee House (Hosford, FL)
Millie Bee Farm (Marianna, FL)
Blue Ridge Honey Company (Lakemont, GA)
Us Honeybee LLC (Captain Cook, HI)
Farm Supply Coop (Hilo, HI)
As It Should Be Apiaries (South Bend, IN)
Next to Nature Farm (Leavenworth, KS)
Jim Brown Supply Co (Middlesboro, KY)
Woodcamp Farm (Mt. Airy, MD)
Napoleon Bee Supply (Napoleon, MI)
Isabees Beekeeping (Fenton, MO)
Nixa Hardware (Nixa, MO)
Bailey Bee Supply (Hillsborough, NC)
Blue Ridge Bee Supply (Mt Airy, NC)
Miller Bee Supply (North Wilkesboro, NC)
Honey and the Hive (Weaverville, NC)

Midnight Bee Supply (Vass, NC)
Hidden Happiness Bee Farm (Deep Gap, NC)
Waynes Feed Store (Murphy, NC)
Valhalla Bee Farm (Lincoln, NE)
The Northern Garden (Stratford, NH)
Hungry Bear Farms (Canandaigua, NY)
Hudson Valley Bee Supply (Kingston, NY)
Kutiks Honey Farm (Oxford, NY)
White Tree Farm (Lancaster, OH)
RJ's Bee Farm (Owasso, OK)
Down to Earth (Eugene, OR)
Bedillon Honey Farm (Hickory, PA)
Beeworks LLC (Perkasie, PA)
Bee Well Honey (Pickens, SC)
Johnsons Bees & Supplies (Williston, SC)
Dakota Honey (Piedmont, SD)
D & M Ag Supply (Rapid City, SD)
The Bee Cause (Drummonds, TN)
Bee Weaver (Navasota, TX)
Winding Creek Apiaries (Willis, TX)
Hands on Beekeepers (Chesapeake, VA)
Uptown Girls Honey (Chesterfield, VA)
Poor Valley Bee (Hiltons, VA)
Erskine Grain and Garden (Chester, VT)
Let It Bee, Inc. (Greenville, WI)
Hansen Honey (Rhineland, WI)

DADANT BRANCH LOCATIONS

Hamilton, IL

51 S. 2nd Street, Hamilton, IL 62341-1370

Ph: (217) 847-3324 Fax: (217) 847-3660 Toll-Free: 888-922-1293 Email: dadant@dadant.com
Monday-Friday — Time Zone CST 7:00 a.m. to 4:00 p.m.

Chico, CA

15 C. Valley Ct., Chico, CA 95973-0171

Ph: (530) 893-0921 Fax: (530) 893-0922
Toll-Free: 877-332-3268 Email: dadantchico@dadant.com
Monday-Friday — Time Zone PST Saturday (March 1- June 1)
8:00 a.m. to 11:30 a.m. 8:00 a.m. - Noon
12:30 p.m. to 4:30 p.m. Closed Dec. 24th - Jan. 2nd

Abion, MI

704 N Clark St., Suite 3, Albion, MI 49224-9506

P.O. Box 183, Albion, MI 49224-0183
Ph: (517) 629-2860 Fax: (517) 629-3039
Toll-Free: 877-932-3268 Email: dadantmi@dadant.com
Monday-Friday — Time Zone EST 8:00 a.m. to 5:00 p.m.

High Springs, FL

17074 Northwest 188th Street, High Springs, FL 32643-7339

P.O. Box 888, High Springs, FL 32655-0888
Ph: (386) 454-0237 Fax: (386) 454-0240
Toll-Free: 877-832-3268 Email: dadanths@dadant.com
Monday-Friday — Time Zone EST 8:00 a.m. to 5:00 p.m.
Saturday — Jan. to May-excluding Holiday weekends
8:00 a.m. to Noon Commercial sales only by appointment.

Williamsport, PA

2925 W 4th St. Bldg 3, Unit 2, Williamsport, PA 17701

Ph: (570) 980-9831 (Line 1) Toll-Free: 877-532-3268
Ph: (570) 980-9736 (Line 2) Fax: (570) 980-9781
Email: dadantpa@dadant.com
Monday-Friday — Time Zone EST 8:00 a.m. to 5:00 p.m.
Saturdays — April - June, excluding holiday weekends
9:00 a.m. - 1:00 p.m.

Fresno, CA

3914 N Winery Ave., Fresno, CA 93727-7450

Ph: (559) 495-0230 Fax: (559) 495-0232
Toll-Free: 877-432-3268 Email: dadantfresno@dadant.com
Monday-Friday — Time Zone PST 7:00 a.m. to 4:00 p.m.

Paris, TX

1169 Bonham Street, Paris, TX 75460-4056

P.O. Box 146, Paris, TX 75461-0146
Ph: (903) 784-6145 Fax: (903) 784-2161
Toll-Free: 877-632-3268 Email: dadanttx@dadant.com
Monday-Friday — Time Zone CST 8:00 a.m. to 5:00 p.m.
3rd Saturday of the month (January - June) 9 a.m. - 3 p.m.

Frankfort, KY

955 Chenault Road, Building D, Frankfort, KY 40601-9428

Ph: (502) 848-0000 Fax: (502) 848-0009
Toll-Free: 888-932-3268 Toll-Free Fax: 866-932-3268
Email: dadantky@dadant.com
Monday-Friday — Time Zone EST 8:00 a.m. to 5:00 p.m.
Saturday (March, April, May & June) 8:00 a.m. - 1:00 p.m.

Chatham, VA

820 Tightsqueeze Industrial Rd., Chatham, VA 24531-3305

Ph: (434) 432-8461 Fax: (434) 432-8463
Toll-Free: 800-220-8325 Email: dadantva@dadant.com
Monday-Friday — Time Zone EST 8:00 a.m. to 5:00 p.m.
Saturday — (March 1- June 1) 8:00 a.m. to Noon

Sioux City, IA

1318 11th Street, Sioux City, IA 51105

P.O. Box 1735, Sioux City, IA 51102-1735
Ph: (712) 255-3232 Fax: (712) 255-3233
Toll-Free: 877-732-3268 Email: dadantia@dadant.com
Monday-Friday — Time Zone CST
8:00 a.m. to Noon, 1:00 p.m. to 5:00 p.m.

Watertown, WI

W2763 East Gate Drive, Watertown, WI 53094-9718

P.O. Box 331, Watertown, WI 53094-0331
Ph: (920) 261-5363 Fax: (920) 261-2309
Toll-Free: 877-232-3268 Email: dadantwi@dadant.com
Monday-Friday — Time Zone CST
8:00 a.m. to Noon, 1:00 p.m. to 5:00 p.m.

Dadant Warranty

Dadant & Sons, Inc., warrants its equipment to be free of defects in material and workmanship. If within 30 days of purchase you feel an item to be defective, please return the merchandise along with your sales slip at once, and we will refund the purchase price along with all transportation charges. This warranty does not cover any damage to equipment arising from alteration, abuse, or use of product for other than its intended purpose. We reject all implied and expressed warranties.

Convenient Ways To Pay

Check
Wire Transfer
Bank Letter of Credit



For Your Convenience We Accept



INDEX

8 Frame Equipment 24, 25-30

A

American Bee Journal 106
 ABJ Binder 106
 Amino-B Booster 45
 AntCant 20, 30
 AP23 48
 Ap23 Winter 47
 Apiguard 56
 Apistan 57
 Apivar 58
 Apron 74
 Assembled Woodenware 6-8, 12,
 22, 27, 30, 54, 61-62

B

Bag, Gift 131
 Bakeware 119, 132
 Baskets, Cappings 82
 BBQ Sauce 132
 Bee Blanket 81
 Bee Dun 76
 Bee Escapes 75
 Bee Go 76
 Bee Gym 54
 Beehive Components Chart 4
 Bee Max Equipment 31
 Beeswax Craft Sheets 129
 Beeswax 1 lb. Cake 129
 Beetle Traps 53
 B-Funnel 5
 Beginner Kits 7, 8, 10, 25, 26, 31
 Bellows 32, 33
 Binder, ABJ 106
 Books 38, 107-112, 115-120, 122, 126
 Boot Bands 68
 Bottlers 95, 96
 Bottling Bucket Kit 80
 Bottom Board 6, 19, 28, 31, 54
 Branch Information 137
 Brood Builder 46
 Brush, Bee 35
 Buckets 43, 104
 Bucket Bench 80

C

Cage, Queen 65
 Cake Pans 119, 132
 Candle:
 Beeswax 129
 Dipping Rack & Vayt 128
 Melting Pot 128
 Silicone Release Spray 128
 Tea Light Cups 128
 Wick 128, 129
 Candle Making 126-129
 Candle Making Kit 126
 Candy Boards 47
 Candy, Honey 132
 Cappings Basket 82
 Cappings Scratcher 77
 Capping Spinner 86
 Caps, Container 101
 Cart, Super 81
 Catch Box 60
 Children's Suit 71
 Certan B402 59
 Clarifier 93
 Clothing 67-74
 Cloake Board 62
 Collars for Squeeze Bears 101
 Colorant, Soap 124

Combcapper 78
 Comb Cutter 38, 78
 Comb Honey 38, 39
 Company Policy 135
 Complete supplement 44
 Containers:
 Bears 100
 Bulk, Jugs & Pails 101, 102, 104
 Comb Honey 39, 102
 Glass 43, 97-98
 Plastic 99
 Skep 98
 Covers 68

Covers:
 BeeMax 31
 Easy-On Bee Hive Cover 47
 Flat Wood 21
 Garden, Copper 28
 Inner 22, 29, 31, 75
 Insulated 21
 Migratory 21
 Nuc Plywood 61
 Stainless Tank 94
 Telescoping 6, 21, 28
 Creamed Honey Kit 121
 Cutter, Soap 124
 Cylinder Jars 98

D

Dadant Locations 137
 Decal 134
 Dipper, Wooden Honey 102
 Disease Management 49
 Domes, Plastic 22, 28
 Drone Comb 16, 54
 DVD's 38, 113, 114

E

Embedders 17
 Entrance Reducers 37
 Entrance Disc 64
 Escape, Bee 75
 Excluders 23, 60
 Extracting Kits 87
 Extractors 81, 85, 86, 87, 88, 89
 Eyelet Punch 17
 Eyelets 17
 EZ-Frames 12, 16
 EZI Queen 63

F

Faucet 3/4" 104
 FAQs 2-4, 11
 Feed Chart 40
 Feeders, Bee 31, 41-43
 Feeds 44-48
 Fill Master 94
 Filter, Honey 91
 Filter Bags, Honey 91
 Flash Heater 93
 Food Approved Lubricant 85
 Form Board 17
 Formic Pro 57
 Foundation Description 11
 Foundation for:
 5¹¹/₁₆ Super 15, 39
 6³/₈ Super 14
 9⁵/₈ Super 13
 Drone Cell 16, 54
 Round Comb Honey 39
 Section/Cut Comb 39
 Small Cell 16, 54
 Frame:
 Board, Frame 17

Cleaner 38
 Fixer 37
 Grip 35
 Holder 37
 Rests/Rabbets 18, 37
 Spacers 37
 Spacing Tool 35
 Wire 17

Frames:
 Assembled 12
 EZ Plastic 12
 Frames for:
 5¹¹/₁₆ Super 15, 39
 6³/₈ Super 12, 14, 16
 9⁵/₈ Super 12, 13, 16
 Fructose 40
 Fructose Pump 40
 Fume Board, Turbo 76
 Fume Pad 76
 Fumidil-B 45

G

Gaskets, Drum 81
 Gates, Honey 92, 104
 Gifts 130-134
 Gloves 71, 73-74
 Glycerine, Soap 123
 Grafting Tools 64
 Grease 85

H

Healthy Bees 49-50
 Heaters:
 Band & Pail 81
 Flash 93
 Immersion 81
 Hex Jars 98
 Hive:
 Bodies 6, 9, 13, 27
 Carrier 36
 Complete 6-10, 27
 Garden 25
 Inspection Sheets 50, 117
 Kits 7, 8, 9-12, 25, 26
 Net 36
 Stand 20, 28, 31
 Support Hive 62
 Tool 34
 Top Bar Hive 134
 Hive Alive 44
 Hive Customization 3
 Honey Grader 105
 Honey-B-Gone 76
 Honey-B-Healthy 45
 Honey Straws 133

J

Jackets 67-71
 Jars, Honey 97-100
 Jesters EZ Nuc 61

K

Keychain 133
 Knives 38, 77, 78
 Kit:
 Bottling Bucket 80
 Candle Making 126-129
 Creamed Honey 121
 Extracting 87
 Hive 6, 7, 8, 9, 10, 13, 25, 26, 31
 Lip Balm 121
 Mead Making Kit 131
 Oxalic Acid 55

INDEX cont.

Soap Making	122-125		
L			
Labels	39, 103		
Landing Boards	19, 20, 28, 30, 54		
Lids:			
Cappings Tank	82		
Container	101		
Honey Tight	80		
Remover Tool	104		
Lip Balm Kit	121		
Liquefier	82		
Lye	123		
M			
Magnet	134		
Mailing Cages	65		
Map-Dadant Branches	Back Cover		
Master Pollinator Kit	7		
Mailing Box	66		
Medications	55-59		
Medication Usage Chart	50		
Melters:			
Electromelt	84		
10 & 25 Gallon	95		
Mini Melter	84		
Solar	83		
Wax (For Candles)	129		
Mite Away Quick Strips	57		
Mite Management	49		
Mold:			
Candle	127		
Soap	124, 125		
Moisture Box 8- & 10-frame	47		
Moth Control, Paramoth	59		
Moving Accessories	36		
Multi-function tool	34		
Muth Jars	98		
N			
Nails	18		
Netting:			
Hive	36		
Nuc, Package	5		
Nozevit Plus	44		
Nuc Boxes	61		
Nuc Screen Bottom Board	61		
O			
Observation Hive	134		
Oils, Soap	123		
Oxalic acid	55		
Oxalic acid kit	55		
Oxalic vaporizers	55		
P			
Package Bees	5		
Pail	43, 104		
Pail Holder	104		
Pallet Clips	36		
Paramoth	59		
Patties	46-48		
Plastic Domes	22, 28		
Plasticell	13-15		
Pollen Trap	24		
Poster	117		
Pro Nuc Box	61		
Propolis Trap	24		
Pumps:			
Honey	91		
Fructose	40		
Progressive Cavity	91		
Pump Control/Strainer	93		
Q			
Queen:			
Cage Holder	65		
Candy Cap	66		
Cell Cups	66		
Cell Protectors	63, 66		
Clip Catcher	64		
Clipping Scissors	64		
Cloake Board	62		
Entrance Disc	64		
Excluder	23, 30		
EZI-Queen System	63		
Follower Boards	62		
Mailing Cage	65		
Marking Cage	64		
Muff	64		
Nuc Introduction Board	62		
Paint Markers	63		
Rearing Hotel	62		
Shipping Carton	65		
Queen Rearing	60-66		
R			
Rabbets, Metal	18		
Reducers, Entrance	37		
Refractometers	105		
Respirator - Half-mask	55		
Rim & Sticks Spacer Set	56		
Robber Screens	36		
Rod Support	18		
Round Section	39		
S			
Scale, Soap/Candle	122		
Scratcher, Cappings	77		
Screened Bottom Boards	6, 19, 28, 31, 54		
Screen Robber	36		
Screens:			
Strainer	80, 94		
Varroa	54		
Seals, Tamper Resistant	102		
Shim Super	22, 29		
Shrink Bands	102		
Sieve, Double	79		
Signs	130		
Skep Jars 3oz/12oz	98		
Slatted Rack	20, 29		
Small Hive Beetle Trap	53		
Smoker Bellows	32, 33		
Smoker Fuel	33		
Smokers	32, 33		
Snap Caps	101		
Soap Making	122-125		
Soap Making Kit	122		
Soap Molds	124, 125		
Speed Control	89		
Spinner, Capping	86		
Spout Cap	101		
Spray, Wasp and Hornet	134		
Spur Embedder	17		
Stands, Hive	6, 20, 30		
Stand, Adjustable Bottle Filling	79		
Stand, Bucket Filter	79		
Staples, Hive	36		
Sticky Board	54		
Stirring System	99, 100		
Stops the Sting	134		
Strainers	79, 80		
Strap, Tie Down	36		
Suits	67-69, 71		
Super Cart	81		
SuperDFM	44		
Supers	6, 8-10, 13-15, 27, 39		
Support Hive	62		
Support Pins	18		
Swarm Catch	60		
Swarm Catch Box	60		
Swarm Lures	60		
Sweat Bands	73		
T			
Tanks:			
Cappings	82		
Clarifier	93		
Pantry	90		
Scraper	90, 96		
Stainless	90		
Storage	90		
Uncapping	78, 82		
Water-Jacketed	93, 95, 96		
Terramycin	52		
Tetra-B Mix	52		
Thermometer	91, 122, 127		
Thumb Screw, Metal			
Replacement	92, 104		
Tie Down Strap	36		
Toolbox, Multipurpose	134		
Tools	34, 35		
Top Bar Hive	134		
Trap:			
Pollen	24		
Propolis	24		
Swarm Catch	60		
Small Hive Beetle	53		
Trousers	69, 71		
Truck, Drum Handling	81		
Turbo Fume Board	75		
U			
Uncapping Equipment	77-80		
V			
VFD Laws	51		
Valves	92, 96, 104		
Vaporizers	55		
Varroa Easy Check	54		
Varroa Screen	19, 54		
Veils	71-72		
Vitamin-B-Healthy	45		
W			
Wax Moth Control	59		
Wax Pan	79		
Wax Tube Fastener	38		
Wax Working Rates	11		
Wick Needle	127		
Wicking	127, 129		
Wire Crimper	17		
Wire, Frame	17		
Woodenware	13-15, 19, 21-22, 25-29, 39, 41-43, 61, 62		
Wood Pellets	33		

FOR WINE AND MEAD MAKING go to:
www.dadant.com/catalog/more/wine-mead-making

FOR DOG COLLARS & LEASHES go to:
<https://www.dadant.com/catalog/more/gifts/pets>



DADANT & SONS, INC.
 51 South 2nd Street
 HAMILTON, IL 62341-1397



CHANGE SERVICE REQUESTED

DADANT BRANCH LOCATIONS & TOLL-FREE NUMBERS

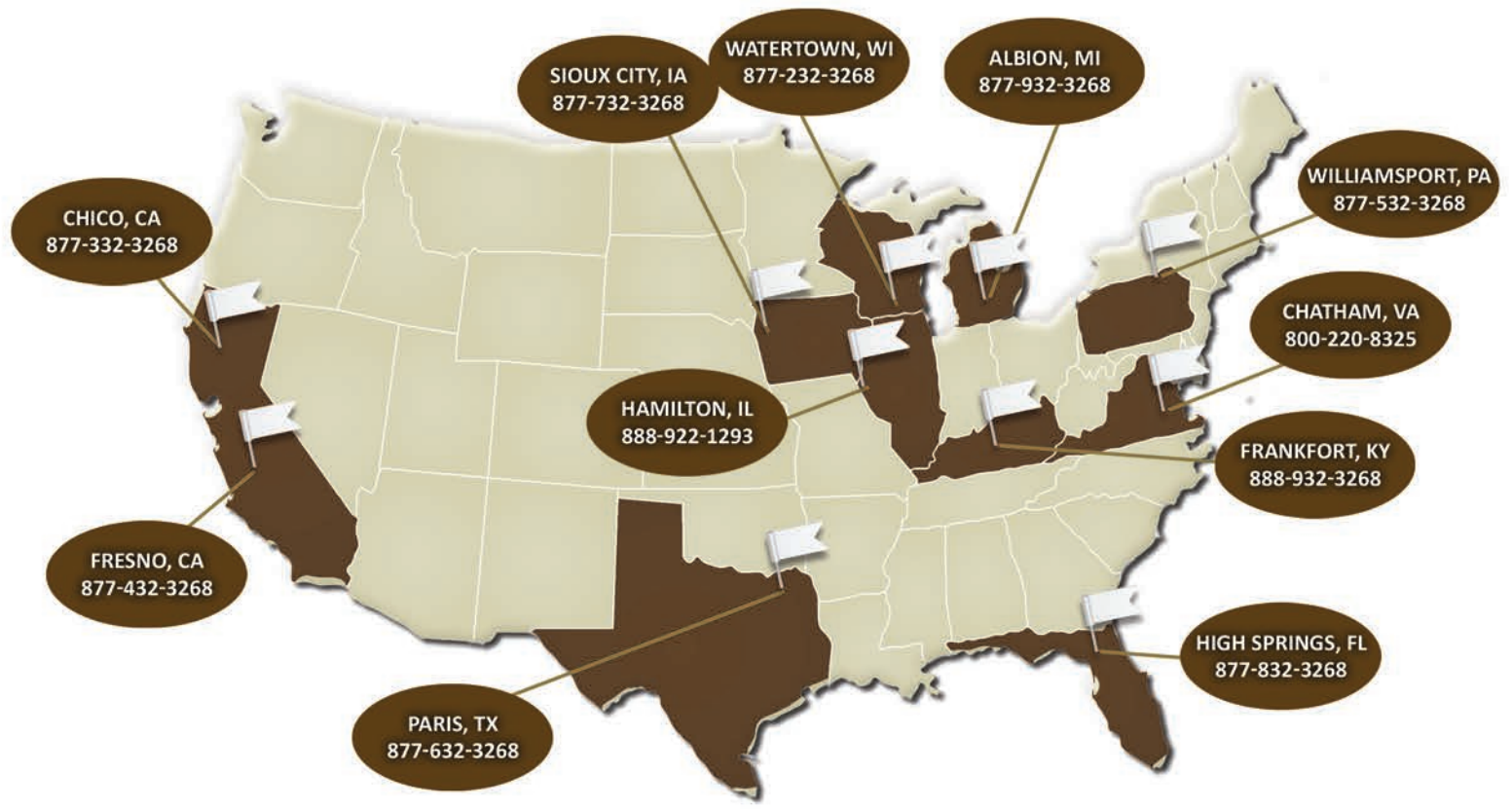

Email: dadant@dadant.com
 Website: www.dadant.com

