



**2021**

AMERICAN MADE  
HIVES  
SMOKERS  
EXTRACTORS  
TANKS  
DADANT 1863

AMERICAN MADE  
100%  
DOMESTIC  
BEESWAX  
FOUNDATION  
DADANT 1863

 *Dadant*  
*Family Owned Since 1863*

# ME? BEEKEEPING!

## Man's Love Affair with the Honey Bee

Even before recorded history, man was gathering honey from honey bees living in hollow trees. But honey wasn't the only reason for keeping honey bees because man soon learned that the honey bee was an interesting and exciting social insect. The mystery and fascination of the hive, how honey bees live, work and reproduce has intrigued man ever since.

## Beekeeping as a Hobby or Vocation

Dadant and Sons has been supplying the beekeeping industry with supplies and equipment since 1863. In that time we have developed equipment that makes beekeeping easy and fun, even for the inexperienced beginner.

Hundreds of thousands of people in all walks of life have become enthusiastic beekeepers. Whether it is in your own backyard, apartment, rooftop, small town garden or farm, beekeeping can fit in anywhere.

## The Honey Bee Colony

The story behind what appears to be the casual movement of honey bees from flower to flower is the discovery of an industrious and tireless society. Honey bees are social insects. They band together and divide labor. The honey bee society is made up of three types of individuals with sharply defined duties and functions. The population of the colony numbers from about 7,000 in mid winter to over 70,000 in late summer and consists of one Queen, several hundred Drones and thousands of Workers.

## How Honey Bees Work

Most all flowers produce a sweet liquid to attract insects, primarily honey bees, so that pollination can take place and assure the survival of that plant species. Honey bees make honey from nectar found inside the flower blossom. Field worker honey bees collect the nectar and carry it back to the hive in pouches within their body. The field worker honey bee gives the nectar to young worker honey bees back in the hive, who then place the nectar in a beeswax comb made up of six sided cells. The excess water is then evaporated from the nectar. After a period of time the nectar is transformed into pure honey.

Some workers collect nectar, some collect pollen and some do both. In terms of economic value the workers that collect pollen are the most important to you and I. Honey is just the sweet, secondary reward that we collect from honey bees. If honey bees ceased to exist today, about one-third (1/3) of all foods we eat would disappear. Why? Because of pollination. The worker that collects pollen from the flowers packs it into pellets on her hind legs. As she travels from flower to flower, the pollen brushes off onto a special pollen receiving structure called the stigma in the center of the flower. This process is called pollination and allows all flowering crops to reproduce. The outcome is fruit, vegetables, nuts and a wide variety of seeds that are used for human and animal foods. For this reason many people keep bees on farms and near gardens.

## The Worker

The female worker honey bee is the laborer of the colony. Workers gather all the nectar and pollen, feed young larvae, warm and protect eggs, larvae and pupae, supply water, secrete beeswax, build comb and do many other tasks.

The worker starts as a fertilized egg, which hatches into a larva. The larva grows, matures and soon changes into the next form called a pupa. The pupa then matures into an adult worker honey bee. The entire metamorphosis takes only 21 days.

During the summer honey flow, June through August, worker honey bees travel about 55,000 miles to gather enough nectar to produce one pound of honey. Each individual worker will only produce about  $\frac{1}{12}$  of a teaspoon of honey and about  $\frac{1}{80}$  of a teaspoon of beeswax. However, an entire colony can produce 200 lbs of honey annually!



## The Queen

Honey bee colony life revolves around the queen honey bee. Without the eggs that she lays the entire colony would die. She begins life as an ordinary female worker larva, but by feeding on an extremely rich mixture of food, provided by young worker honey bees called Royal Jelly, she becomes a queen. A new queen can be produced at any time, if the young workers choose, by feeding any female larvae less than 48 hours old royal jelly.

The queen's function is to lay eggs. Day after day the queen lays thousands of eggs which will develop into more honey bees. She is continually surrounded, protected and fed by young worker honey bees.



## The Drone

The drone is the male honey bee. He is larger than the worker and smaller than the queen.

Except for mating, the drone is an expendable member of the colony. Drones do not collect nectar or pollen nor do they make beeswax. In fact, they are driven from the colony as winter approaches where they perish from cold and starvation.



# FREQUENTLY ASKED QUESTIONS ABOUT BEEKEEPING

## When do I order package bees?

It is best to order package bees at the beginning or very early in the year for spring delivery. The bees should be delivered after the date of the last hard freeze for your region. The package honey bee suppliers will be able to help you determine the best delivery date.

## When should I hive my new package of honey bees?

The best time to hive the honey bees is late afternoon or early evening. Spray the honey bees with sugar water while still in the shipping container. This will make it easier to put the honey bees in the hive.

## What kind of frames should I use when starting with package bees?

It is best not to mix solid plastic frames with wood frames when hiving package bees. It is confusing to the bees when mixed. We recommend using wood frames when hiving package bees.

## What do I feed the honey bees in the spring?

It is best to feed a mixture of sugar and water in a one to one ratio. The bees will use the sugar syrup mixture until natural sources are available. In the fall, use a two part sugar to one part water mixture if the bees do not have adequate winter stores. Feeders on pages 62 -64 work well. You can also stimulate the honey bees to raise brood by feeding them Dadant's Brood Builder Patties or AP23® Patties. These items can be found on pages 67 - 68.

## Where do I place my hive?

If you are in the city, you should put the entrance of the hive facing a high fence. This will force the bees to fly in a high flight pattern, avoiding neighbors. It is good to give the hives a wind break to protect them. You can also place the entrance facing the sun to allow the bees an early start in the morning. The hive can also be placed on a hive stand, concrete blocks or a wooden pallet to keep it off of the ground.

## Do I paint the inside of the beehive?

No, paint the outside of the beehive only. Allow the paint to dry thoroughly before installing the bees.

## How often should I check my new hive?

You can open the hive after a few days to see if the queen has been released. Look in the Queen Cage to see

if the Queen has been released. If the Queen has been released, you should check for eggs and larvae to be sure she is active. If the Queen has not been released, enlarge the hole in the candy in the Queen Cage. Three weeks after you have hived the package, you can examine the colony again. Be sure to keep feeding the colony sugar syrup during this time to stimulate comb building. You should see sealed brood in the colony at this time.

## Can I keep bees in a straw skep?

No, honey bees are required to be kept in a beehive with removable frames. This is to allow inspection for diseases. It is the law in all states.

## When should I add a second hive body or super?

You should add the second hive body or super when the majority of the frames in the first hive body are fully drawn out, (8 or 9 frames). A second super should be added after the first super is about one half full.

## How much honey should I leave on the hive to overwinter?

As a general rule, you should have a full super or second hive body and 20 to 30 pounds of honey in the brood nest. This will amount to a total of 60 to 70 pounds of honey for winter and early spring consumption.

## What should I look for in spring in the colony?

You should check for evidence that the Queen is laying eggs. You should also check the honey stores and pollen supply. If the honey stores are low, you may start feeding sugar syrup in a one to one ratio of sugar and water. The bees may consume about 10 pounds of sugar syrup in a one-week period.

## How can I get information or help about beekeeping in my area?

All 50 states have state and local associations and are a very good source of information and help. They will be able to direct you to a bee club or an association in your area. For contact information on the state associations call us at 1-888-922-1293 or visit <http://americanbeejournal.com/tiposlinks/beekeeping-associations/>.

**THE HONEY BEE IS THE ONLY INSECT  
THAT PRODUCES FOOD EATEN BY MAN.**



# QUALITY WOODENWARE — A DADANT MANUFACTURING SPECIALTY

## Hive Customization

At Dadant we understand that beekeepers do things their own way. That said we are happy to customize your bee hive needs. From branding, painting, dipping, and assembly we can customize your bee hive to fit your style. Give your local Dadant location a call about customizing your hives today. All customized orders must meet the minimum requirement of 500+ hives to qualify..

## Branding

With all the beehive thefts going on within the industry we have been asked by many to bring branding back to our line of customization. We are happy to do so. Let us know what you would like branded and we will do our best to accommodate your needs.

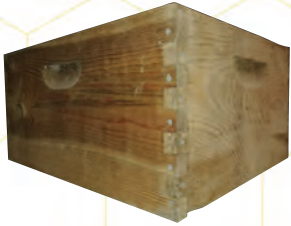

## Painting and Dipping

We are happy to be able to offer unpainted, painted, and dipped boxes. Our protective coatings will help your boxes last for years to come. Inquire today about other colors or copper methanolamine dipped boxes. Copper methanolamine dipped boxes only available through our High Springs, FL office. Lead times may vary. Ordering in advance is encouraged.



## Imprinting of Frames

Dadant assembled frames will be stamped with our logo and year unless otherwise requested. If you wish to have your logo or something else stamped we are happy to try and accommodate your needs.

Give us a call at 888-922-1293 today.



## Hive Bodies And Honey Supers

- **HANDHOLDS** tapered cut for easy gripping
- **MOISTURE METERING** before cutting to prevent warping
- **UNIFORM INTERLOCKING JOINTS** to prevent cracking
- **PONDEROSA PINE** from the Northwest. The best wood for the job.
- **UNIFORM FRAME RESTS** provides the proper "Bee Space"
- **PRE-DRILLED NAIL HOLES** to prevent splitting
- **INTERLOCKING CONSTRUCTION** for superior strength



*Dadant Construction . . .  
Small Details Make A Big Difference*

### Ponderosa Pine Wood Products

Our woodenware is manufactured from hand selected Ponderosa Pine. Each board has been carefully moisture-metered to assure its proper moisture content before it is precision-milled into the finished product. All our hive bodies and supers have "pre-drilled" holes for nails to prevent splitting during assembly.

## 3 Basic Grades

**Select** — A grade that is truly "selected" which allows only very small tight knots and no deviations in the joints, rabbets, or handholds.

**Commercial** — The most widely used by commercial beekeepers. Tight knots are allowed where they occur except in the joint and rabbet.

**Economy** — The same precise fit as the other two grades but is a lower wood quality. Does not pass quality standards for "select" or "commercial" but is a good serviceable box. Layer knots and knots with cracks or splits are allowed.

## DADANT QUALITY FRAMES



### Dadant Frame Construction

- 8% more wood in end bars (Full 3/8" thickness)
- Grooved bottom bar stronger and easier to use

### —2 Frame Styles—

#### Wedge Top Bar

- 1) Wood wedge is removed from frame.
- 2) Foundation is placed in frame.
- 3) Wood wedge is held firmly against foundation and nailed or stapled in place.

#### Grooved Top Bar

Foundation is placed in bottom-bar groove and top-bar groove. This frame works best with a rigid foundation such as Plasticell.

*We will strive to maintain woodenware prices; however, due to escalating lumber costs, wood price increases may be necessary.*

**NOTE:** Unless otherwise specified, frames with grooved bottom bars will be shipped. **SOLID AND SLOTTED BOTTOM BARS ARE AVAILABLE IN 100 OR MORE QUANTITIES.** Please specify bottom bar desired.

# BEEHIVE COMPONENTS

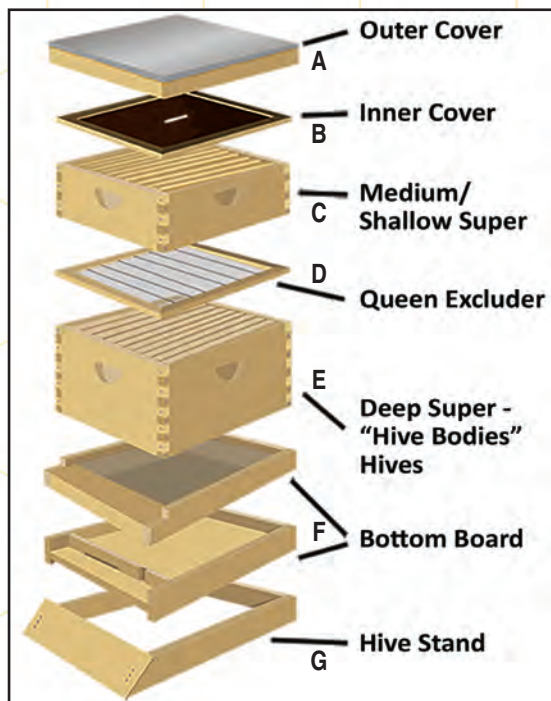

The modern beehive is like a highly efficient multi-storied factory with each “story” having a specific function. These “stories” work together to provide a home for bees and a honey factory for the beekeeper.

**A) Outer Cover** — Telescoping cover “telescopes” over the sides of the top super to protect the hive. Galvanized covering.

**B) Inner Cover** — Creates a dead air space for insulation from heat and cold.

**C) Shallow Supers** — For “surplus” honey storage. Bees store their extra honey in these for the beekeeper to take. 6%”, 5”x16” supers or even hive bodies may be used.

**D) Queen Excluder** — Keeps the queen bee in the brood chambers as she is too large to pass through the excluder. Prevents her from laying eggs and raising brood in honey supers placed above the excluder.

**E) Hive Bodies** — “Brood Chambers” are the bees’ living quarters. The queen lays eggs in these chambers and brood is raised. Honey and pollen is also stored for the bees’ food.

**F) Bottom Board** — Forms the floor of the hive. Shown with wooden entrance reducer in place to keep mice and some cold out during winter.

**G) Hive Stand** — Supports the hive off the ground to keep hive bottom dry and insulate hive.

Successful beekeeping means easy manipulation of the frames of brood and honey to provide a “surplus” of honey beyond that needed by the bees to live on and rear their replacements. It is this “surplus” that the beekeeper removes and markets.

## BEEKEEPING EQUIPMENT

### The Frame

The modern hive for the honey bee as provided by *Dadant and Sons* is the perfect home for your honey bees and makes beekeeping remarkably simple and enjoyable. The hive is constructed to hold movable frames which in turn hold pure beeswax foundation (starter sheets for honeycomb). These frames hold the honeycomb that the honey bees make. The honeycomb provides storage space for honey and new bees develop in its individual six sided cells.



### The Hive Tool

Honey bees collect a miscellaneous product called propolis from tree gums, saps and resins — anything sticky. This they use to seal cracks and crevices within the hive. Because of the sticky nature of this product a special tool is used for those times when a little leverage is necessary to remove frames, supers, etc. from the hive.

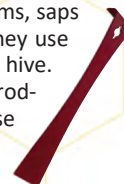

### The Hive Body (brood chamber)

These large boxes containing ten (10) frames are the heart of the honey bee colony. Usually two hive bodies are used year round for the honey bees to use as an area to raise brood (larva and pupa) and to store extra food for themselves for use during winter when no nectar is available.

### The Super

Additional boxes, usually smaller than the hive bodies, with movable frames are set on top of the brood chamber and provide space for the honey bee to store surplus honey which the beekeeper will harvest. The word Super comes from the word Superimpose which means, “to place in a covering position, to overlay.”



### The Smoker

The smoker is a metal container with air pumping bellows attached. A smoldering fire is built in the metal fire chamber and the bellows are used to blow the smoke produced out through a nozzle at the top of the smoker.



When lightly puffed into a colony of honey bees the smoke causes a temporary confusion and disorganization within the colony. The honey bee’s group defensive behavior is disrupted. This allows the beekeeper to move calmly and to comfortably inspect the interior of their colonies.

### The Bee Veil

The bee veil protects the face and neck. Many times it is made from wire mesh to help the veil stand away from the face.



### The Gloves

There are a variety of types and styles of gloves available from *Dadant & Sons*. Gloves provide the beekeeper with protection when working the honey bee colony.



# ATTENTION: DADANT PACKAGE BEE CUSTOMERS for Pick-up only at Dadant Branches

At the selected Dadant offices listed, bees will be available for pick-up. For details of day, time, location and cost, call your nearest Dadant Branch Location. (Most pickup days are mid-April.)



## Package Bee Netting | Nuc Bee Netting

When we saw customers putting package bees in plastic tubs for the car ride home we thought we'd find a better way to help secure your cargo. Our package bee and nuc bee netting is perfect for the ride home w/no escapees. Each fit over a 3lb package of bees or a 5-frame nuc box. Get your bee netting today to bee safe on the ride home.

V02004S Package Bee Netting, Ship wt. 1 lb. . . . . \$4.50  
V02004L Nuc Bee Netting, Ship wt. 1 lb. . . . . \$5.60

## B-Funnel

The B-Funnel is designed to reduce stress and save time and effort when installing package bees. Made of corrugated plastic, it is very easy to put together and use. A velcro strap holds it securely against the hive. The beekeeper then positions the bee cage on top of the funnel. The B-Funnel channels the bees directly into the hive, reducing the number of bees in the air. It assists the bees in finding their new home, is less stressful for the bees, and can be removed as soon as the bees have left the package box. Fits 8- and 10-frame hives.



M01985 B-Funnel, Ship wt. 1 lb. . . . . \$13.35

## Suggestions for Hiving Your Package Bees



1 To keep bees from flying we suggest spraying them down with sugar syrup.



2 Jar package on ground to knock bees to the bottom of package.



3 Remove syrup can and queen cage. Cover hive in package with piece of cardboard or feed can.



4 Place queen between top bars with the candy end up. Use a wire or nail to hold in place.



5 Shake 2-3 cups worth of bees directly on top of queen and remaining bees in frame slots 5, 6, 7.



6 Gently place frames back into hive and cover being careful not to crush the bees.



7 Reduce entrance to keep bees from absconding.



8 Feed, feed, feed. Feed until first real honey flow or bees stop taking syrup.



9 Check back in 4-5 days after installing to be sure your queen is released.

Hive top feeders may be used. Division board feeders are not recommended for use with package bees.

**\*\*\* It is essential that you keep feed on the bees until they have an abundance of nectar available. \*\*\***

# ***PACKAGE BEES***

*We ship them direct to your local post office*

**ORDER NOW!**



## **SHIP DATES:**

**April 12**

**April 19**

**April 26**

**May 10**

**May 24**

**May 31**

- *Approximately 3 lbs. of Bees per Package*
- *Naturally Mated Italian Queen Included*

- *Calm and Gentle Italian Bees*
- *No Cage Exchange Necessary*



**ORDER ONLINE AT [WWW.DADANT.COM](http://WWW.DADANT.COM)**

# DADANT COMPLETE HIVES & SUPERS

**We Now Offer Assembled Equipment Primed and Painted for You.**

*No Paint to Buy! No Mess to Clean! (1 primer coat and 1 white exterior latex coat)*



### 6 5/8" Painted Super

C31501P comes assembled with 10 - 6 1/4" Grooved top bar frames with wax coated Plasticell foundation installed in the frames. Commercial grade wood, painted.

Ship wt. 15 lbs.

**C31501P** Carton of 1 ..... \$64.55 ea.



### 9 5/8" Painted Hive Body

C51101P comes assembled with 10 - 9 1/2" Grooved top bar frames with wax coated Plasticell foundation installed in the frames. Commercial grade wood, painted. Ship wt. 19 lbs.

**C51101P** Carton of 1 ..... \$70.00 ea.



### Assembled/Painted Bottom Board

Ship wt. 8 lbs. each

**C91201P** ..... \$25.60 ea.



### Assembled/Painted Tele Cover (only)

Ship wt. 13 lbs. each

**C11001P** ..... \$36.10 ea.

**B15201** Inner Cover sold separately (see page 24)..... \$12.75 ea.



### 10-Frame Ultimate Pine Hive Stand with West Beetle Trap & IPM Board

Made of pine, this all in one painted bottom board will trap and kill SHB, allow you to check for mites with the included IPM board, and gives your bees a landing board to land on. Assembled/Painted

**M60090** ..... \$45.25

## Complete Hive with Wax Coated Plasticell Foundation



- 10 - 9 1/2" Grooved top bar frames with wax coated plasticell foundation
- Superbly constructed 9 5/8" commercial Ponderosa Pine hive body, painted
- Metal frame rests
- Painted telescoping cover with galvanized metal top
- Inner cover
- Reversible painted bottom board for summer and winter bee entrance

Ships in multiple cartons

Ship wt. 50 lbs.

**C52101P** Carton of 1, ..... \$145.80 ea.

**Call for quote on large quantity pricing on unpainted hives or supers.**

*While we hope to maintain prices at all locations, escalating freight costs may necessitate occasional adjustments.*

— NO SUBSTITUTIONS OR PARTIAL RETURNS ON KITS —





**Assembled & Painted**

**C52501P**

**6 5/8" Assembled Starter Kit**

- 3 - 6 5/8" supers
- 30 - 6 1/4" grooved top bar frames
- 30 - sheets plastic based foundation
- 1 - bottom board
- 1 - telescoping metal cover
- 1 - inner cover
- 1 - reversible entrance reducer
- 1 - plastic queen excluder
- 1 - entrance feeder
- 1 - all purpose hive tool
- 1 - 4" x 7" bee smoker to calm bees (M00926)
- 1 - smoker fuel 1 lb.
- 1 - bee brush
- 1 - Alexander veil
- 1 - economy leather gloves — large
- 1 - book *First Lessons in Beekeeping*

**C52501P** 6 5/8" Assembled Starter Kit, . . . . . **\$384.80**

Ships in multiple packages: 64 lbs.



**Assembled & Painted**

**C52201P**

**Assembled Starter Kit**

Here at Dadant we strive to make sure you, the beginning beekeeper, have everything you need to start a successful beekeeping venture.

- 1 - bottom board
- 2 - deep brood boxes w/frames and plasticell foundation
- 1 - medium depth super w/frames and plasticell foundation
- 1 - inner cover and top cover
- 1 - plastic queen excluder
- 1 - boardman entrance feeder
- 1 - reversible entrance reducer
- 1 - hive tool
- 1 - 4" x 7" smoker to calm bees (M00926)
- 1 - smoker fuel 1 lb.
- 1 - bee brush
- 1 - Hat Veil Pullover Combo
- 1 - economy leather gloves
- 1 - book *First Lessons in Beekeeping*

**C52201P** Assembled Starter Kit. . . . . **\$401.65**

Ships in multiple packages: 80 lbs.

**Master Pollinator Kit**

- 1 - Assembled painted telescoping metal cover
- 2 - Assembled painted hive bodies w/wooden frames & plasticell
- 1 - Assembled Painted Bottom board
- 1 - Inner cover
- 1 - Smoker - 4" x 7" Stainless Steel w/shield
- 2 - 1 lb. of smoker fuel
- 1 - Entrance feeder
- 1 - Metal 9 1/2" hive tool
- 1 - Bee brush
- 1 - Dadant zipper veil suit (available in S, M, L, XL, 2XL, 3XL, 4XL)
- 1 - Economy leather gloves (available in S, M, L, XL, XXL)
- 1 - Dadant plastic helmet
- 1 - Book—*First Lessons in Beekeeping*
- 1 - Book—*The Hive and the Honey Bee*
- 1 - 1 Year Subscription—*American Bee Journal*

**M58001 - \$411.95**

Ships in multiple packages: 85 lbs.

*Please state suit and glove size when ordering.*



**Assembled & Painted**

— NO SUBSTITUTIONS OR PARTIAL RETURNS ON KITS —

[www.dadant.com](http://www.dadant.com)



C52301P

Assembled & Painted

**Expanding Apiary Kit  
— Assembled & Painted—**

The expanding apiary kit is all you will need to add a hive to your operation. The kit comes completely assembled and painted with a Ponderosa pine bottom board, two full depth 9 $\frac{1}{2}$ " brood boxes, two medium 6 $\frac{5}{8}$ " depth honey supers, assembled frames w/plasticell foundation, inner cover w/telescoping cover and entrance reducer.

C52301P ..... \$332.55  
Ships in multiple packages: 85 lbs.



**PONDEROSA PINE LASTS LONGER**

**6 $\frac{5}{8}$ " Expanding Apiary Kit  
— Assembled & Painted —**

The 6 $\frac{5}{8}$ " kit is all you need to add a hive to your operation. Comes completely assembled, painted and ready for the bee yard with a Ponderosa pine bottom board, four 6 $\frac{5}{8}$ " supers, assembled frames w/plasticell foundation, inner cover w/telescoping cover and entrance reducer.

C52401P ..... \$315.05  
Ships in multiple packages: 72 lbs.



Assembled & Painted



C52401P

**Call for quote on large quantity pricing on unpainted hives or supers.**

*While we hope to maintain prices at all locations, escalating freight costs may necessitate occasional adjustments.*

— NO SUBSTITUTIONS OR PARTIAL RETURNS ON KITS —

1-888-922-1293

# DADANT UNASSEMBLED HIVES & SUPERS

## Complete Hive without foundation

— UNASSEMBLED —

- Telescoping cover with galvanized metal top



B52101

- Superbly constructed 9 $\frac{5}{8}$ " select grade Ponderosa Pine hive body

**Not Assembled**

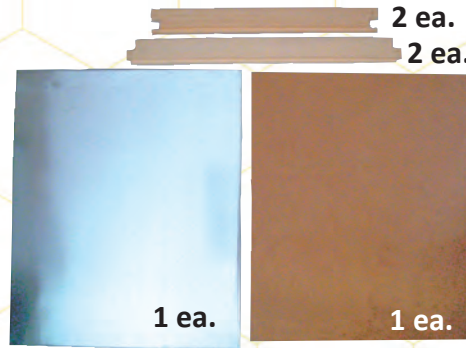

• Inner Cover

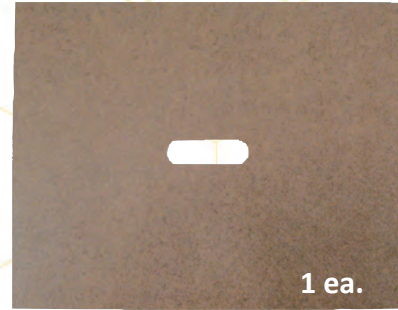

1 ea.



2 ea.

2 ea.

- Reversible Bottom Board for summer and winter bee entrance

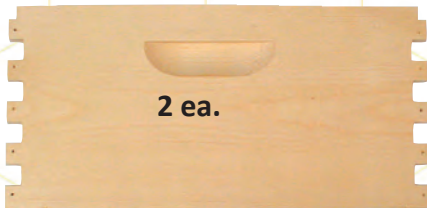

2 ea.



2 ea.

- 10 - 9 $\frac{5}{8}$ " Wedged Top Bar Frames



10 ea.

10 ea.

20 ea.

Nails included for all components.

Frame rests not included

B52101 Ship wt. 35 lbs  
Carton of 1..... \$93.30  
5 or more..... \$83.10

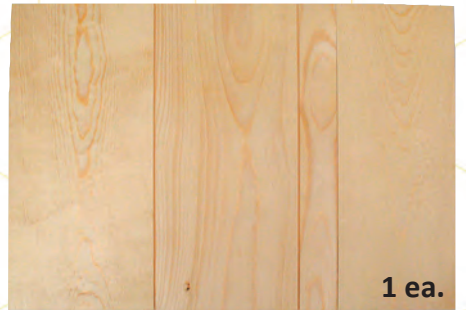

1 ea.



2 ea.



1 ea.



1 ea.



1 ea.

Wood Entrance Reducer

*Notice: Select Wood may not be available at all branch locations.*

## Hive Body with Frames

B51101



2 ea.



2 ea.

20 ea.



10 ea.



10 ea.

**Not Assembled**

B51101 - Unassembled with 10 Wedged Top Bar Frames. Nails included. **Select Grade Wood.**  
Ship wt. 17 lbs.

B51101 Carton of 1. . . . \$37.35 ea.

Frame rests not included

6 $\frac{5}{8}$ " Depth Super with Frames  
Ship wt. 13 lbs.

B31101 Carton of 1, . . . \$36.15 ea.

5 $\frac{1}{16}$ " Depth Supers with Frames  
Ship wt. 13 lbs.

B32101 Carton of 1, . . . \$35.15 ea.

## Honey Supers With Frames

B31101



2 ea.



2 ea.

20 ea.



10 ea.



10 ea.

B31101 & B32101 Unassembled with 10 wedged Top Bar Frames. Nails included. Select Grade Wood.

See page 14 for your favorite Dadant foundation.

While we hope to maintain prices at all locations, escalating freight costs may necessitate occasional adjustments.

— NO SUBSTITUTIONS OR PARTIAL RETURNS ON KITS —

www.dadant.com

# ESSENTIALS OF BEEKEEPING — BEGINNERS KITS

## Beginner's Kit #1

Beginner Kit No. 1 contains everything necessary for the beginner to start that first colony of bees except the bees themselves. Unassembled kit with the best grade wood. As your colony grows, we recommend the Hobby Kit #3 for the additional items needed for production of a honey crop. Ship wt. 39 lbs.

- 1 - standard beehive
- 10 - 9 $\frac{1}{8}$ " grooved top bar frames
- 10 - sheets plastic based foundation
- 1 - bottom board
- 1 - inner cover
- 1 - telescoping metal cover
- 1 - reversible entrance reducer
- 1 - entrance feeder
- 1 - all purpose hive tool
- 1 - bee smoker to calm bees
- 1 - smoker fuel 1 lb.
- 1 - Hat Veil Pullover Combo
- 1 - sting resistant gloves - large
- 1 - book *First Lessons in Beekeeping*
- 1 - assembly instructions

**M58101** ..... \$205.95



## Hobby Kit #2

Hobby Kit No. 2 contains everything needed to get started in beekeeping except the bees themselves. Using the standardized size of 6 $\frac{3}{8}$ " for both brood boxes and supers eliminates confusion of reordering multiple sizes of frames & foundation. Smaller size makes for easier handling. Ship wt. 46 lbs.

- 2 - 6 $\frac{3}{8}$ " supers
- 20 - 6 $\frac{3}{8}$ " grooved top bar frames
- 20 - sheets plastic based foundation
- 1 - bottom board
- 1 - telescoping metal cover
- 1 - inner cover
- 1 - reversible entrance reducer
- 1 - entrance feeder
- 1 - all purpose hive tool
- 1 - bee smoker to calm bees
- 1 - smoker fuel 1 lb.
- 1 - Hat Veil Pullover Combo
- 1 - sting resistant gloves - large
- 1 - book *First Lessons in Beekeeping*
- assembly instructions

**M59601** ..... \$226.35



## Hobby Kit #3

### For Those Desiring To Produce Extracted Honey

Hobby Kit No. 3 is designed to accommodate those who intend to produce extracted honey. Kit #3 contains two 6 $\frac{3}{8}$ " supers with frames, foundation and plastic excluder. Ship wt. 27 lbs.

- 2 - 10 pack Plasticell 5 $\frac{1}{2}$ " coated
- 1 - plastic excluder
- 2 - 6 $\frac{3}{8}$ " Supers
- 2 - c/10 GTB frames for supers
- assembly instructions

**B38301** ..... \$101.80



# ASSEMBLED FRAMES

## STRENGTH where it counts!

Our assembled frames continue to feature a full 1/2" thick bottom bar along with a full 3/4" thick top bar.

### Assembled Frames with Foundation Carton of 10



Machine to manufacture assembled frames with foundation at our Hamilton, IL. location. Each frame is secured by ample amounts of glue along with heavy duty staples to hold frame structure.



**C75210**  
9 1/8" GTB/GBB  
Ship wt. 11 lbs.  
C75210 C/10 Frames . . . \$37.00 ea.



**C76210**  
6 1/4" GTB/GBB  
Ship wt. 9 lbs.  
C76210 C/10 Frames . . . \$34.50 ea.

### 9 1/8" GTB/GBB Assembled Frames with Coated Plasticell Foundation

Ship wt. 1 lb. ea.

|               |                             |
|---------------|-----------------------------|
| <b>C75201</b> |                             |
| 10 .....      | \$3.70                      |
| 50 .....      | \$3.40                      |
| 100 .....     | \$2.95                      |
| 400+ . . .    | Call for Price 888-922-1293 |

### 6 1/4" GTB/GBB Assembled Frames with Coated Plasticell Foundation

Ship wt. 1 lb. ea.

|               |                             |
|---------------|-----------------------------|
| <b>C76201</b> |                             |
| 10 .....      | \$3.45                      |
| 50 .....      | \$3.10                      |
| 100 .....     | \$2.89                      |
| 400+ . . .    | Call for Price 888-922-1293 |

On Large quantity orders prices are FOB –  
Call local Branch for Pricing

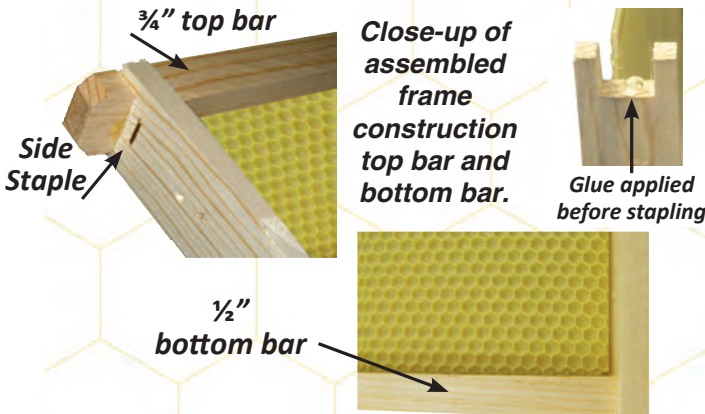

**PONDEROSA PINE LASTS LONGER**

**Contact your local branch for a quote and availability from their location.**

### EZ FRAMES Sizes Available 9 1/8" and 6 1/4"

**EZ Frames**—One piece food grade plastic frame and wax coated foundation molded together for one long lasting, sturdy unit. You never have to assemble frames and foundation again. That's why it's called EZ Frame.

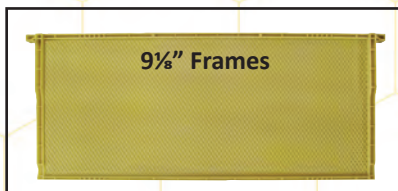

9 1/8" Frames

**M58705**

9 1/8" EZ Frames, each

|           |        |
|-----------|--------|
| 10 .....  | \$3.30 |
| 50 .....  | \$3.05 |
| 100 ..... | \$2.45 |
| 200 ..... | \$2.25 |

Wax Moth Cannot Damage Base

Food Grade Plastic wax coated  
at Hamilton, IL

Ship wt. 1 lb. each  
500+ Call for Quantity Pricing

On Large quantity orders prices are FOB  
– Call local Branch for Pricing

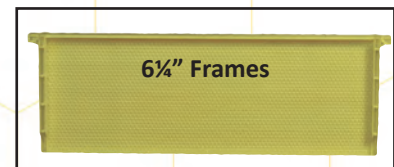

6 1/4" Frames

**M58725**

6 1/4" EZ Frames, each

|           |        |
|-----------|--------|
| 10 .....  | \$3.20 |
| 50 .....  | \$2.95 |
| 100 ..... | \$2.55 |
| 200 ..... | \$2.35 |

**Contact your local branch for a quote and availability from their location.**

# DADANT FOUNDATION — THE KEY TO SUCCESSFUL BEEKEEPING

Fresh Quality Foundation Makes Good Productive Combs

Dadant Quality Foundations—  
Only 100% Pure U. S. Beeswax Is Used

## Medium Brood

The Original 100% Pure Beeswax Foundation

Our Lowest Priced Foundation

Precise Even-Milled  
Worker-Sized Deep  
Walled Cells

We Recommend Cross Wiring  
Frames With Medium Brood Foundation

## Crimp Wired

Developed By Dadant & Sons  
Copied But Unequaled

Steel Hook Fits Behind Wedge  
In Top Bar

9 Vertical Crimped Steel Wires  
Perfectly Milled Cells  
Deep Exact Walls  
Radiate Strength

We Recommend Adding Cross Wires In Deep Frames

## Cut Comb

Finest Comb Honey Foundation 100% Beeswax

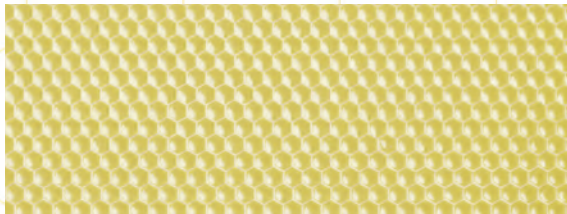

Cut comb is slightly heavier than thin surplus  
for easier handling. Cut Comb For Chunk Honey and  
Comb Honey Cut From The Frame

## Thin Surplus

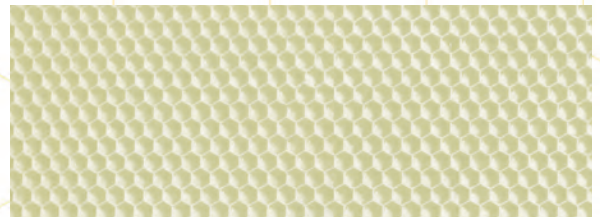

The thinnest beeswax sheet  
for the finest comb honey. Thin Surplus For  
Square and Round Section Comb Honey

## “Plasticell”

Raised-Cell Sheet, Best Plastic Foundation  
Available, Tested and Proven



Deep Uniform  
Exact Cells

Wax Coated or Plain  
(We recommend  
Wax Coating.)

Unique Uniform Spray  
Wax Coating

Fits Frame Sizes 9 7/8" and 6 1/4"

Food Grade Plastic  
Wax coated  
at Hamilton, IL

Wax Moth Cannot  
Damage Base

## EZ Frames

1 Piece Plastic Frame and Foundation  
No Assembly — No Wiring  
Strong — Durable  
Not Affected By Weather Conditions

Sizes 9 7/8" and 6 1/4"

Wax Coated

Now Available in Sizes 4 3/4" and 6 1/2"

BUY BEESWAX FOUNDATION MOST ECONOMICALLY WITH DADANT'S WAX WORKING PLAN FOR 25# OR MORE

### WAX WORKING RATES

| Wax Working Number | Foundation Type          | Working Rates per Pound |           |
|--------------------|--------------------------|-------------------------|-----------|
|                    |                          | Min. of 25# to 100#     | Over 100# |
| F60001             | Crimp-Wired, w/top hooks | 3.70                    | \$3.65    |
| F60002             | Crimp-Wired, no hooks    | 3.65                    | \$3.60    |
| F60004             | Medium Plain             | 3.50                    | \$3.45    |
| F60005             | Thin Surplus             | 4.05                    | \$4.00    |
| F60006             | Cut Comb                 | 4.05                    | \$4.00    |

Call for pricing on Small Cell Wired or Medium Plain

Note: Add \$.03 per pound to figures shown for all shallow sizes (4 3/4" and below).

Please Note: Working rates for Thin Surplus and Cut Comb Foundations are based on customers providing light wax. Additional upcharges will apply if light wax is not supplied.

All prices are for 25 lb. bulk packs. Additional charges will be assessed for less than 25 lb. per carton packaging. (i.e. 10 and 50 sheet packs and 1 lb. and 5 lb. single packs) — (Special sizes—200# Wax Working Minimum or Additional \$110 set-up charge applies. Small Cell orders under 200# will have a \$300.00 set up fee.)

The Dadant Company has been working wax into foundation for their customers for many years. Our wax working rates include all the many steps it takes to process your wax into the finest 100% beeswax foundation available. Careful inspection during every step of the manufacturing process, along with durable and protective packaging, insures a final product of superior quality. Because of the low prices reflected in the working rates, we must have your beeswax before shipping foundation and do require payment for the working charge. Beeswax foundations cannot be shipped safely in cold weather. For further information on the wax working program, contact your local branch manager.

# 10-FRAME BEEKEEPING EQUIPMENT

## HIVE BODIES, FRAMES AND FOUNDATION FOR "9 5/8" DEEP SUPERS



For quantities of 500+ Call for price

**Not Assembled**

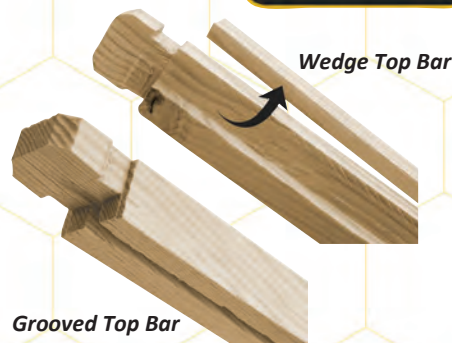

| Hive Bodies — 9 5/8" Deep Supers |                              |                                       |  |  |  |  |
|----------------------------------|------------------------------|---------------------------------------|--|--|--|--|
| Wood Grade<br>(see page 4)       | L Rabbits and Nails Included |                                       | Quantity<br>Nails Not Included (See page 20) |  |  |  |
|                                  | Carton of 1                  | Carton of 5                           | 1 - 10                                       | 11-49                                      | 50-249                                     | 250 - 499                                  |
|                                  | <b>Select</b>                | B51201<br>Ship wt. 11 lbs.<br>\$25.60 | B51205<br>Ship wt. 48 lbs.<br>\$115.45       | B50230<br>Ship wt. 8.5 lbs. ea.<br>\$23.30 | B50230<br>Ship wt. 8.5 lbs. ea.<br>\$22.80 | B50230<br>Ship wt. 8.5 lbs. ea.<br>\$19.55 |
| <b>Commercial</b>                |                              |                                       | B50270<br>Ship wt. 8.5 lbs. ea.<br>\$19.80   | B50270<br>Ship wt. 8.5 lbs. ea.<br>\$18.60 | B50270<br>Ship wt. 8.5 lbs. ea.<br>\$16.25 | B50270<br>Ship wt. 8.5 lbs. ea.<br>\$15.10 |
| <b>Economy</b>                   |                              |                                       | B50501<br>8.5 lbs. ea.<br>\$17.45            | B50501<br>8.5 lbs. ea.<br>\$16.25          | B50501<br>8.5 lbs. ea.<br>\$12.75          | B50501<br>8.5 lbs. ea.<br>\$11.65          |

| 9 5/8" Frames for 9 5/8" Hive Bodies        |                                      |                                       |   |   |  |
|---|--------------------------------------|---------------------------------------|---|---|--|
| Frame Style<br>(see page 4)                 | Nails Included                       |                                       | Quantity (Please order in multiples of 100)<br>Nails Not Included (See page 20) |   |  |
|   | Carton of 10                         | Carton of 50                          | 100-400   | 500-4900  | 5000 and Up                                      |
|   | <b>9 5/8" Wedge Top Bar Frames</b>   | B75110<br>Ship wt. 7 lbs.<br>\$17.45  | B75150<br>Ship wt. 27 lbs.<br>\$70.00   | B85001<br>Ship wt. 50 lbs./100<br>\$116.15/100  | B85001<br>Ship wt. 250 lbs./500<br>\$107.40/100  |
| <b>9 5/8" Grooved Top Bar Frames</b>        | B75210<br>Ship wt. 7 lbs.<br>\$16.25 | B75250<br>Ship wt. 27 lbs.<br>\$63.60 | B85201<br>Ship wt. 50 lbs./100<br>\$108.45/100                                  | B85201<br>Ship wt. 250 lbs./500<br>\$100.35/100 | B85201<br>Ship wt. 2500 lbs./5000<br>\$98.00/100 |
| <b>9 5/8" Economy Grade (Budget) Frames</b> | Wedge Top Bar                        | B850011                               | \$93.35/100<br>Ship wt. 50 lbs./100   | \$91.75/100<br>Ship wt. 250 lbs./500            | \$89.10/100<br>Ship wt. 2500 lbs./5000           |
|   | Groove Top Bar                       | B852011                               | \$92.15/100   | \$91.00/100                                     | \$87.80/100                                      |

| 100% U.S. Beeswax Foundation for 9 5/8" Frames See Wax Working Rates—Page 14 |                                     |                          |             |                 |                  |             |                  |
|--|-------------------------------------|--------------------------|-------------|-----------------|------------------|-------------|------------------|
| Foundation Type<br>(see page 14)   | Size                                | Frame Style Used In      | Item Number | Sheets Per Lb.* | Quan. Per Carton | Ship Weight | Price Per Carton |
| <b>Crimp Wired</b>   | fits 9 5/8" frame<br>8 1/2 x 16 3/4 | Wedge Top Bar Only       | F35010      | 7               | 10 sheets        | 3           | \$18.50          |
|  |                                     |                          | F35050      | 7               | 50 sheets        | 9           | \$77.20          |
|  | no hook                             | Wedge or Grooved Top Bar | F35000      | 7               | 25 lbs.          | 31          | \$205.95         |
| <b>Medium Brood</b>  | fits 9 5/8" frame<br>8 1/2 x 16 3/4 | Wedge Top Bar            | F38410      | 7               | 10 sheets        | 2           | \$16.45          |
|  |                                     |                          | F38450      | 7               | 50 sheets        | 8           | \$77.20          |
|  |                                     |                          | F38400      | 7               | 25 lbs.          | 33          | \$205.95         |

BELOW 38 DEGREES SHIPS AT BUYER'S RISK.

| Plasticell—Plastic Foundation for 9 5/8" Frames Available in Black or Yellow |                                     |                |             |            |  |  |  |
|--|-------------------------------------|----------------|-------------|------------|--|--|--|
| Plasticell<br>Available in Yellow or Black                                   | fits 9 5/8" frame<br>8 3/8 x 16 3/4 | Sheet Quantity | Ship Weight |            | F36000<br>Yellow<br>Uncoated<br>F36000B<br>Black<br>Uncoated | F37000<br>Yellow<br>Wax Coated<br>F37000B<br>Black<br>Wax Coated | F37000DC<br>Yellow<br>Wax Double Coated<br>F37000BDC<br>Black<br>Wax Double Coated |
|  |                                     |                | Uncoated    | Wax Coated |  |  |  |
| <b>Wedge Top Bar or Grooved Top Bar</b>                                      |                                     | 10             | 4#/10       | 5#/10      | Call   | \$1.75   | \$1.95   |
|  |                                     | 50             | 16#/50      | 19#/50     | Call   | \$1.70   | \$1.90   |
|  |                                     | 100            | 32#/100     | 38#/100    | Call   | \$1.60   | \$1.80   |
|  |                                     | 1000           | 320#/1000   | 380#/1000  | Call   | \$1.55   | \$1.75   |
|  |                                     | 2000           | 640#/2000   | 760#/2000  | Call   | \$1.30   | \$1.50   |

For quantities of 3000+ Call for price 1-888-922-1293

\*Sheets per lb. are approximate and may vary in the manufacturing process.

Special Supers, Frames, Foundation and Frame Parts Available CALL FOR QUOTE 1-888-922-1293

While we hope to maintain prices at all locations, escalating freight costs may necessitate occasional adjustments.

# 10-FRAME BEEKEEPING EQUIPMENT

## SUPERS, FRAMES AND FOUNDATION FOR "6<sup>5</sup>/<sub>8</sub>" SUPERS



### 6<sup>5</sup>/<sub>8</sub>" Dadant Depth Honey Supers

| Wood Grade<br>(see page 4) | Nails Included                       |                                       | Quantity<br>Nails Not Included (See page 20) |  |  |  |
|----------------------------|--------------------------------------|---------------------------------------|--|--|--|--|
|                            | Carton of 1                          | Carton of 5                           | 1-10   | 11-49                                    | 50-249                                   | 250 - 499                                |
| Select                     | B31201<br>Ship wt. 6 lbs.<br>\$20.35 | B31205<br>Ship wt. 35 lbs.<br>\$90.20 | B31500<br>Ship wt. 6 lbs. ea.<br>\$19.80     | B31500<br>Ship wt. 6 lbs. ea.<br>\$18.05 | B31500<br>Ship wt. 6 lbs. ea.<br>\$13.45 | B31500<br>Ship wt. 6 lbs. ea.<br>\$13.15 |
|                            |                                      |                                       | B34100<br>Ship wt. 6 lbs. ea.<br>\$14.80     | B34100<br>Ship wt. 6 lbs. ea.<br>\$14.40 | B34100<br>Ship wt. 6 lbs. ea.<br>\$10.55 | B34100<br>Ship wt. 6 lbs. ea.<br>\$9.80  |
| Commercial                 |                                      |                                       | B34201<br>Ship wt. 6 lbs. ea.<br>\$12.70     | B34201<br>Ship wt. 6 lbs. ea.<br>\$11.60 | B34201<br>Ship wt. 6 lbs. ea.<br>\$9.75  | B34201<br>Ship wt. 6 lbs. ea.<br>\$9.30  |
| Economy                    |                                      |                                       |  |  |  |  |



For quantities of 500+ Call for price

Not Assembled

### 6<sup>1</sup>/<sub>4</sub>" Frames for above 6<sup>5</sup>/<sub>8</sub>" Honey Supers

| Frame Style<br>(see page 4)                                   | Nails Included                       |                                       | Quantity (Please order in multiples of 100)<br>Nails Not Included (See page 20) |   |   |
|---|--------------------------------------|---------------------------------------|---|---|---|
|   | Carton of 10                         | Carton of 50                          | 100-400   | 500-4900  | 5000 and Up                                       |
| 6 <sup>1</sup> / <sub>4</sub> " Wedge Top Bar Frames          | B76110<br>Ship wt. 6 lbs.<br>\$17.45 | B76150<br>Ship wt. 26 lbs.<br>\$70.00 | B85003<br>Ship wt. 48 lbs./100<br>\$116.15/100                                  | B85003<br>Ship wt. 240 lbs./500<br>\$107.40/100 | B85003<br>Ship wt. 2400 lbs./5000<br>\$104.95/100 |
| 6 <sup>1</sup> / <sub>4</sub> " Grooved Top Bar Frames        | B76210<br>Ship wt. 6 lbs.<br>\$16.25 | B76250<br>Ship wt. 26 lbs.<br>\$70.00 | B85203<br>Ship wt. 48 lbs./100<br>\$108.45/100                                  | B85203<br>Ship wt. 240 lbs./500<br>\$98.00/100  | B85203<br>Ship wt. 2400 lbs./5000<br>\$87.75/100  |
| 6 <sup>1</sup> / <sub>4</sub> " Economy Grade (Budget) Frames | Wedge Top Bar                        | B850031                               | \$89.00/100<br>Ship wt. 48 lbs./100   | \$87.40/100<br>Ship wt. 240 lbs./500            | \$84.85/100<br>Ship wt. 2400 lbs./5000            |
|   | Groove Top Bar                       | B852031                               | \$87.75/100   | \$86.10/100                                     | \$83.60/100                                       |



### 100% U. S. Wax Foundations for 6<sup>1</sup>/<sub>4</sub>" Frames Wax Working Rates—Page 14

| Foundation Type<br>(see page 14) | Size   | Frame Style Used In      | Item Number | Sheets Per Lb.* | Quan. Per Carton | Ship Weight | Price Per Carton |
|----------------------------------|--|--------------------------|-------------|-----------------|------------------|-------------|------------------|
| Crimp Wired                      | fits 6 <sup>1</sup> / <sub>4</sub> " frame<br>5 <sup>7</sup> / <sub>8</sub> x 16 <sup>1</sup> / <sub>2</sub> | Wedge Top Bar Only       | F35310      | 11              | 10 sheets        | 2           | \$12.55          |
|                                  |  |                          | F35350      | 11              | 50 sheets        | 7           | \$54.80          |
|                                  | no hook  | Wedge or Grooved Top Bar | F35300      | 11              | 25 lbs           | 31          | \$205.95         |
| Medium Brood                     | fits 6 <sup>1</sup> / <sub>4</sub> " frame<br>5 <sup>7</sup> / <sub>8</sub> x 16 <sup>1</sup> / <sub>2</sub> | Wedge Top Bar            | F38610      | 11              | 10 sheets        | 2           | \$14.35          |
|                                  |  |                          | F38650      | 11              | 50 sheets        | 7           | \$54.55          |
|                                  |  |                          | F38600      | 11              | 25 lbs           | 31          | \$205.95         |
| Cut Comb                         | fits 6 <sup>1</sup> / <sub>4</sub> " frame<br>5 <sup>7</sup> / <sub>8</sub> x 16 <sup>1</sup> / <sub>2</sub> | Wedge Top Bar            | F32301      | 16              | 1 lbs            | 2           | \$13.15          |
|                                  |  |                          | F32305      | 16              | 5 lbs            | 7           | \$60.65          |
|                                  |  |                          | F32300      | 16              | 25 lbs           | 31          | \$286.20         |

BELOW 38 DEGREES SHIPS AT BUYER'S RISK.

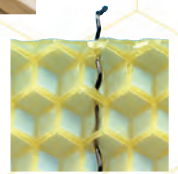

Crimp Wired



Medium Brood



Cut Comb

### Plasticell—Plastic Foundation for 6<sup>1</sup>/<sub>4</sub>" Frames Available in Black or Yellow

| Plasticell                 | fits 6 <sup>1</sup> / <sub>4</sub> " frame<br>5 <sup>7</sup> / <sub>8</sub> x 16 <sup>1</sup> / <sub>2</sub> | Frame Style Used In | Sheet Quantity | Ship Weight |            | F36200<br>Yellow Uncoated<br>F36200B<br>Black Uncoated | F37200<br>Yellow Coated<br>F37200B<br>Black Coated | F37200DC<br>Yellow Double Coated<br>F37200BDC<br>Black Double Coated |
|----------------------------|--|---------------------|----------------|-------------|------------|--|--|--|
|                            |  |                     |                | Uncoated    | Wax Coated | Call   | Call   | Call   |
| Uncoated or Beeswax Coated | Wedge Top Bar or Grooved Top Bar   | 10                  | 3#/10          | 3#/10       | Call       | \$1.55   | \$1.70   |  |
|                            |  | 50                  | 12#/50         | 13#/50      | Call       | \$1.50   | \$1.65   |  |
|                            |  | 100                 | 23#/100        | 26#/100     | Call       | \$1.45   | \$1.60   |  |
|                            |  | 1000                | 230#/1000      | 260#/1000   | Call       | \$1.15   | \$1.30   |  |
|                            |  | 2000                | 460#/2000      | 520#/2000   | Call       | \$1.10   | \$1.25   |  |

For quantities of 3000+ Call for price



Black Plasticell



Yellow Plasticell

\*Sheets per lb. are approximate and may vary in the manufacturing process.

Special Supers, Frames, Foundation and Frame Parts Available CALL FOR QUOTE

While we hope to maintain prices at all locations, escalating freight costs may necessitate occasional adjustments.

1-888-922-1293



# 10-FRAME BEEKEEPING EQUIPMENT

## SUPERS, FRAMES AND FOUNDATION FOR "5<sup>11</sup>/<sub>16</sub>" SUPERS



| 5 <sup>11</sup> / <sub>16</sub> " Shallow Supers For quantities of 500+ Call for price |                                      |                                       |  |  |  |  |
|--|--------------------------------------|---------------------------------------|--|--|--|--|
| Wood Grade<br>(see page 4)   | Nails Included                       |                                       | Quantity<br>Nails Not Included (See page 20) |  |  |  |
|  | Carton of 1                          | Carton of 5                           | 1-10   | 11-49  | 50-249                                       | 250 - 499                                    |
| <b>Select</b>  | B32201<br>Ship wt. 5 lbs.<br>\$19.80 | B32205<br>Ship wt. 30 lbs.<br>\$81.65 | B32500<br>Ship wt. 5 lbs. ea.<br>\$17.45     | B32500<br>Ship wt. 5 lbs. ea.<br>\$16.35     | B32500<br>Ship wt. 5 lbs. ea.<br>\$15.15     | B32500<br>Ship wt. 5 lbs. ea.<br>\$12.80     |
| <b>Commercial</b>  |                                      |                                       | B34400<br>Ship wt. 5 lbs. ea.<br>\$16.25     | B34400<br>Ship wt. 5 lbs. ea.<br>\$15.75     | B34400<br>Ship wt. 5 lbs. ea.<br>\$14.90     | B34400<br>Ship wt. 5 lbs. ea.<br>\$14.65     |
| <b>Economy</b>   |                                      |                                       | B34601<br>Ship wt. 5 lbs. ea.<br><b>Call</b> | B34601<br>Ship wt. 5 lbs. ea.<br><b>Call</b> | B34601<br>Ship wt. 5 lbs. ea.<br><b>Call</b> | B34601<br>Ship wt. 5 lbs. ea.<br><b>Call</b> |



**Not Assembled**

| 5 <sup>3</sup> / <sub>8</sub> " Frames for above Shallow Supers  |   |  |   |   |   |  |
|--|---|--|---|---|---|--|
| Frame Style<br>(see page 4)                                      | Nails Included                            |  | Quantity (Please order in multiples of 100)<br>Nails Not Included (See page 20) |   |   |  |
|  | Carton of 10                              | Carton of 50                               | 100-400   | 500-4900  | 5000 and Up                                       |  |
| <b>5<sup>3</sup>/<sub>8</sub>" Wedge Top Bar Frames</b>          | B77110<br>Ship wt. 6 lbs.<br>\$15.85 each | B77150<br>Ship wt. 25 lbs.<br>\$69.95 each | B85004<br>Ship wt. 47 lbs./100<br>\$115.70/100                                  | B85004<br>Ship wt. 235 lbs./500<br>\$113.75/100 | B85004<br>Ship wt. 2350 lbs./5000<br>\$107.40/100 |  |
| <b>5<sup>3</sup>/<sub>8</sub>" Grooved Top Bar Frames</b>        |   |  | B85204<br>Ship wt. 47 lbs./100<br>\$108.45/100                                  | B85204<br>Ship wt. 235 lbs./500<br>\$100.35/100 | B85204<br>Ship wt. 2350 lbs./5000<br>\$98.00/100  |  |
| <b>5<sup>3</sup>/<sub>8</sub>" Economy Grade (Budget) Frames</b> | Wedge Top Bar                             | B850041                                    | <b>Call</b><br>Ship wt. 47 lbs./100   | <b>Call</b><br>Ship wt. 235 lbs./500            | <b>Call</b><br>Ship wt. 2350 lbs./5000            |  |
|  | Groove Top Bar                            | B852041                                    | <b>Call</b>   | <b>Call</b>                                     | <b>Call</b>                                       |  |

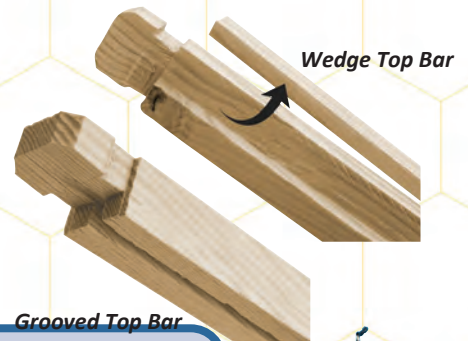

| 100% Wax Foundations for 5 <sup>3</sup> / <sub>8</sub> " Frames See Wax Working Rates — Page 14 |  |                          |             |                 |                  |             |                  |
|---|--|--------------------------|-------------|-----------------|------------------|-------------|------------------|
| Foundation Type<br>(see page 14)  | Size   | Frame Style Used In      | Item Number | Sheets Per Lb.* | Quan. Per Carton | Ship Weight | Price Per Carton |
| <b>Crimp Wired</b>  | fits 5 <sup>3</sup> / <sub>8</sub> " frame<br>4 <sup>3</sup> / <sub>4</sub> x 16 <sup>3</sup> / <sub>4</sub> | Wedge Top Bar Only       | F35210      | 12              | 10 sheets        | 2           | \$12.30          |
|   |  |                          | F35250      | 12              | 50 sheets        | 6           | \$54.80          |
|   | no hook  | Wedge or Grooved Top Bar | F35200      | 12              | 25 lbs.          | 31          | \$205.25         |
| <b>Medium Brood</b>   | fits 5 <sup>3</sup> / <sub>8</sub> " frame<br>4 <sup>3</sup> / <sub>4</sub> x 16 <sup>3</sup> / <sub>4</sub> | Wedge Top Bar            | F38310      | 13              | 10 sheets        | 2           | \$16.45          |
|   |  |                          | F38350      | 13              | 50 sheets        | 7           | \$57.65          |
|   |  |                          | F38300      | 13              | 25 lbs.          | 33          | \$205.95         |
| <b>**Cut Comb</b>   | fits 5 <sup>3</sup> / <sub>8</sub> " frame<br>4 <sup>3</sup> / <sub>4</sub> x 16 <sup>1</sup> / <sub>2</sub> | Wedge Top Bar            | F32201      | 18              | 1 lb.            | 2           | \$11.95          |
|   |  |                          | F32205      | 18              | 5 lbs.           | 7           | \$54.40          |
|   |  |                          | F32200      | 18              | 25 lbs.          | 33          | \$213.30         |
| <b>**Thin Surplus</b>   | fits 5 <sup>3</sup> / <sub>8</sub> " frame<br>4 <sup>3</sup> / <sub>4</sub> x 16 <sup>1</sup> / <sub>2</sub> | Wedge Top Bar            | F31401      | 22              | 1 lb.            | 2           | \$13.15          |
|   |  |                          | F31405      | 22              | 5 lbs.           | 7           | \$59.85          |
|   |  |                          | F31400      | 22              | 25 lbs.          | 33          | \$205.95         |

**BELOW 38 DEGREES SHIPS AT BUYER'S RISK.**

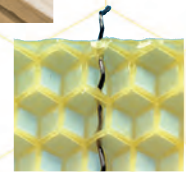

Crimp Wired

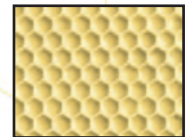

Medium Brood

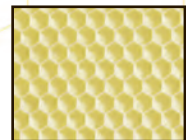

Cut Comb



Thin Surplus



Yellow Plasticell

| Plasticell—Plastic Foundation FOR 5 <sup>3</sup> / <sub>8</sub> " Frames |  |   |                |             |            |                    |                      |
|--|--|---|----------------|-------------|------------|--------------------|----------------------|
| Plasticell   | Fits 5 <sup>3</sup> / <sub>8</sub> " frame<br>4 <sup>3</sup> / <sub>4</sub> x 16 <sup>3</sup> / <sub>4</sub> | Frame Style Used In                     | Sheet Quantity | Ship Weight |            | F36300<br>Uncoated | F37300<br>Wax Coated |
|  |  |   |                | Uncoated    | Wax Coated |                    |                      |
| <b>Uncoated or Beeswax Coated</b>  |  | <b>Wedge Top Bar or Grooved Top Bar</b> | 10             | 3#/10       | 3#/10      | <b>Call</b>        | \$1.55               |
|  |  |   | 50             | 12#/50      | 13#/50     | <b>Call</b>        | \$1.50               |
|  |  |   | 100            | 23#/100     | 26#/100    | <b>Call</b>        | \$1.45               |
|  |  |   | 1000           | 230#/1000   | 260#/1000  | <b>Call</b>        | \$1.15               |
|  |  |   | 2000           | 460#/2000   | 520#/2000  | <b>Call</b>        | \$1.10               |

For quantities of 3000+ Call for price

While we hope to maintain prices at all locations, escalating freight costs may necessitate occasional adjustments.

\*Sheets per lb. are approximate and may vary in the manufacturing process.

\*\*Preferred for cut Comb Honey and Chunk Honey. 4 3/4" foundation is available—Call for Prices. Special Supers, Frames, Foundation and Frame Parts Available CALL FOR QUOTE 1-888-922-1293

[www.dadant.com](http://www.dadant.com)

# FOUNDATION FOR VARROA CONTROL

One piece drone frames come beeswax coated and are available in 9 $\frac{1}{8}$ " and 6 $\frac{1}{4}$ " depths. Comes in neon green color to help you easily identify drone combs. Ship wt. 1 lb. ea



The **Varroa Mite** is, without a doubt, the most serious parasite of honey bees in North America. Ignoring treatment of colonies infested with Varroa mites will result in colony death in 1 to 2 years. Most honey bee colonies in North America are infested with Varroa mites.



Varroa Mite on Honey Bee



M58725D

## 6 $\frac{1}{4}$ " Drone Comb

**M58725D** 6 $\frac{1}{4}$ " coated drone comb  
1-10..... **\$3.85**

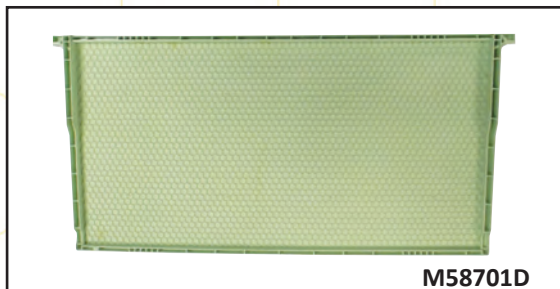

M58701D

## 9 $\frac{1}{8}$ " Drone Comb

**M58701D** 9 $\frac{1}{8}$ " coated drone comb  
1-10..... **\$4.25**

## Drone Cell Foundation

By using a few frames of drone comb, you can lure Varroa mites to the developing drone brood, and the mites become trapped within the drone cell when the bees cap the cells. Remove the frame of capped drone cells. Put it in a plastic bag in your freezer overnight to kill the mites. Remove from the freezer and let warm. With the cappings scratcher (page 79), break open the drone cells. Then, put the frame back into the colony and allow the worker bees to clean out the cells, getting rid of the dead varroa mites and drones. After the queen lays drone eggs in these cells again, this Varroa trapping cycle is repeated.

Varroa Mite



Actual Size

- F45010** 8 $\frac{1}{2}$  x 16 $\frac{1}{2}$ " Medium Brood Drone Comb Foundation  
10 Sheets Per Package, Ship wt. 2 lbs. ea. .... **\$18.05**
- F45050** 50 sheet Medium Brood Drone Comb Foundation  
Ship wt. 9 lbs. ea. .... **\$77.20**
- F45000** 20 lb. Medium Brood Drone Comb Foundation  
Ship wt. 28 lbs. (Approx. 7 sheets per lb.) ea. .... **\$212.15**

## Dadant Small Cell Beeswax Foundation 4.9 & 5.1

It is a fact that varroa mites have a difficult time reproducing on worker brood raised in small cell comb. So, if you are an experienced beekeeper who has an experimental nature, this may be an opportunity for you to move ahead of the chemical control crowd with your honey bee management.

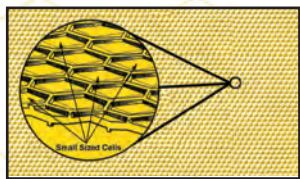

### WHY A 5.1?

Many recommend a transition from the standard 5.4 to the 4.9 cell foundation allowing the bees to adjust more readily and help avoid the erratic comb drawing that can occur with a direct downsizing from the 5.4 to the 4.9—thus a middle step with the 5.1

### AVAILABLE IN PLAIN AND WIRED

**8 $\frac{1}{2}$  x 16 $\frac{1}{2}$ " Plain Small Cell 4.9mm Beeswax Foundation**

**F46010SC** 10 Sheets Per Package  
Ship wt. 3 lbs. ea..... **\$18.05**

**F46050SC** 50 sheets  
Ship wt. 9 lbs. ea..... **\$77.20**

**F46000SC** 25 lbs.  
Ship wt. 33 lbs. ea..... **\$212.15**  
(Approx. 7 sheets per lb.)

**5 $\frac{1}{2}$  x 16 $\frac{1}{2}$ " LH Wired Small Cell 4.9mm Beeswax Foundation**

**F353103SC** 10 Sheets Per Package  
Ship wt. 3 lbs. ea..... **\$14.90**

**F353503SC** 50 sheets  
Ship wt. 9 lbs. ea..... **\$81.70**

**F353003SC** 25 lbs.  
Ship wt. 33 lbs. ea..... **\$212.15**  
(Approx. 7 sheets per lb.)

**8 $\frac{1}{2}$  x 16 $\frac{1}{2}$ " LH Wired Small Cell 5.1mm Beeswax Foundation**

**F350103SC5** 10 Sheets Per Package  
Ship wt. 3 lbs. ea..... **\$18.05**

**F350503SC5** 50 sheets  
Ship wt. 9 lbs. ea..... **\$87.50**

**F350003SC5** 25 lbs.  
Ship wt. 33 lbs. ea..... **\$212.15**  
(Approx. 7 sheets per lb.)

# FRAME/FOUNDATION HARDWARE

Cross wiring is necessary to firmly hold some foundations in place. For example, we recommend 4 cross wires when using 8½" medium brood foundation, but only 2 for holding 8½" crimp wire foundation. Beekeepers even find it advantageous to put one cross-wire in bulk comb foundation — then pulling out the cross-wire from the end of the frame prior to cutting the bulk comb. To prevent the wire from cutting into the frame end bars, we recommend using eyelets to protect the frames.

## Grooved Spur Embedder

This is another style of spur embedder. It has a groove between the wheels that will help make the job easier. *Cannot be used with crimped frame wire.*

**M00721** Grooved Spur Embedder,  
Ship wt. 2 ozs. .... **\$11.85**

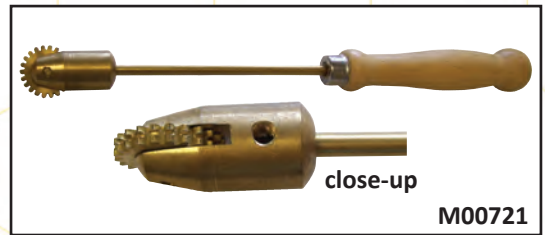

## Spur Embedder

Uses hand pressure to fasten wire in any foundation needing horizontal wires for added support. Roll the wide-tooth spur points along each wire. May be used warm (preferable) or cold. Many beekeepers purchase two — keep one heating while the other is in use.

**M00703** Spur Embedder, Ship wt. 8 oz. ea. .... **\$12.20**

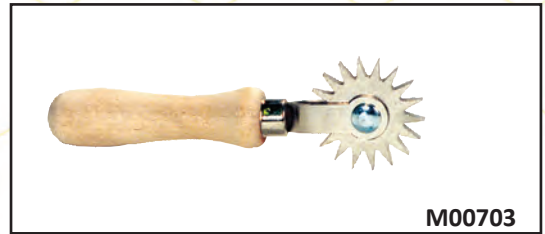

## Wire Crimper

Support your wax foundation by tightening and crimping your frame wire with our wire crimper. Helps give wax foundation the extra support it needs.

**M01943** Wire Crimper,  
Ship wt. 2 ozs. .... **\$9.00**

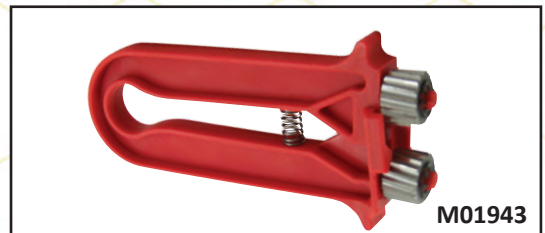

## Brass Eyelets

Small brass eyelets are punched into the wiring holes in end bars of brood and super frames. Prevents wire from cutting into the wood. Keeps horizontal wires tight. Special punch makes insertion simple and easy. Sold separately.

**M00709** 1000 Eyelets, Ship wt. 4 ozs. .... **\$9.05**  
**M00710** 5000 Eyelets, Ship wt. 1 lb. .... **\$40.80**  
**M00711** Punch, Ship wt. 6 oz. .... **\$4.55**

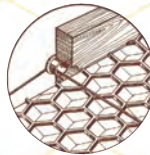

## Frame Wire

Top grade tinned wire made especially for the bee industry with great tensile strength. Should always be used for horizontal wiring brood or extracting frames in which plain or unwired foundation is to be used. May also be used with crimp-wired foundation to gain even greater strength. This wire is 26 gauge.

**M00705** ½ lb. Spool, Ship wt. 1 lb. .... **\$6.75**  
**M00706** 1 lb. Spool, Ship wt. 2 lbs. .... **\$11.30**  
**M00707** 5 lb. Spool, Ship wt. 7 lbs. .... **\$36.20**



## Frame/Form Board

For use with 9½", 6¼" and 5¾" frames. This is a useful tool for nailing frame wedges and inserting foundation in frames. It is a good companion for the spur embedder **M00721** or **M00703** (shown above). It supports the frame with foundation while embedding. May also be used for hand-wiring frames.

**B10301** Form Board, Ship wt. 5 lbs. .... **\$13.90**



## Electric Embedder and Transformer

— Sold Separately —

This embedder, used with the 12 volt transformer shown below, heats horizontal frame wire so it is well-attached, but does not mar the foundation. Embeds one wire at a time.

**M00701** Embedder Only, Ship wt. 2 lbs. .... **\$73.60**  
**M00702** 12 Volt Transformer Only, Ship wt. 2 lbs. .... **\$79.25**



# NAILS, RABBETS AND SUPPORT PINS

## Plastic Support Pins

Slip the pin in the holes on the end bar and slide the sheet of foundation in to securely hold it in place. Minimum of two per end bar. C/100

**M01755** c/100 pins, Ship wt. 1 lb. . . . . **\$11.60**

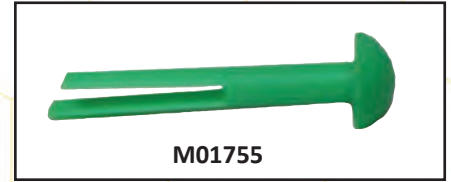

## Plastic Rods

Support Rods – Sick of cross wiring frames? These support rods slide through the holes in the end bars and are locked in place. Wire your frames in seconds. Ship wt. 1 lb.

**M0175410** c/10 rods . . . . . **\$5.25**

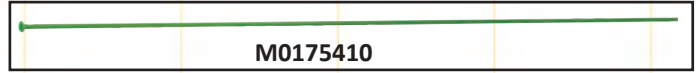

## Support Pins

Support pins are small metal pins similar to clothespins. Simply press these pins through the holes in the frame end bars so foundation is held in pin slot. For many, especially beginning beekeepers using crimp wired foundation in brood chambers, support pins are much easier to use than the sometimes tedious cross wiring to prevent foundation sagging. Cannot be used with Plasticell foundation.

**M00819** 200 pins, Ship wt. 1 lb. . . . . **\$19.25**

**M00820** 1000 pins, Ship wt. 4 lbs. . . . . **\$82.70**

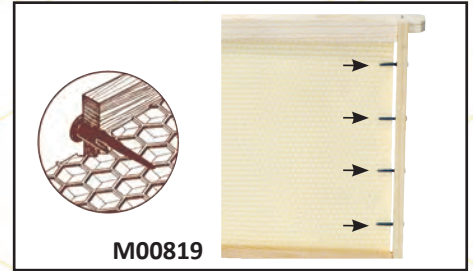

Showing correct placement of staples

## Nails for Frame and Super Assembly

For nailing frame top bars to end bars and for bottom bars to end bars use **M00727** (1 1/4"). For nailing wedges use **M00726** (3/4"). For nailing hive bodies and supers, we recommend **M00731**, 7d (2 1/4") galvanized nails. For nailing bottom boards we recommend **M00730**, 4d (1 1/2") galvanized nails.

| Item Number   | Size and Description | Approx. Qty./lb. | Quantity Price/lb.* |
|---------------|----------------------|------------------|---------------------|
| <b>M00726</b> | 3/4" x 18 gauge      | 2600             | \$9.65              |
| <b>M00727</b> | 1 1/4" x 17 gauge    | 1150             | \$9.65              |
| <b>M00730</b> | 4d galvanized        | 460              | \$7.35              |
| <b>M00731</b> | 7d galvanized        | 180              | \$5.10              |

\*For shipping weight add 2 lbs. to quantity ordered up to 100 lbs. and add 5 lbs. over 100 lbs.

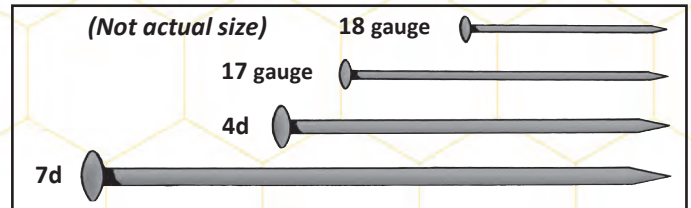

| 9 5/8" Hive Bodies/Deep Supers |  |                       | 6 5/8" Supers |                               |                       | Frames           |                        |                       |
|--------------------------------|--|-----------------------|---------------|-------------------------------|-----------------------|------------------|------------------------|-----------------------|
| Nail Size                      | Nails needed per hive body/ deep super | 1# of nails will make | Nail Size:    | Nails needed per 6 5/8" super | 1# of nails will make | Nail Size:       | Nails needed per frame | 1# of nails will make |
| 7D<br>M00731                   | 36                                     | 5 Hive Bodies         | 7D<br>M00731  | 24                            | 7 Supers              | 3/4"<br>M00726   | 4 nails for wedge only | 650 Frames            |
| 4D<br>M00730                   | 4                                      | 115 Hive Bodies       | 4D<br>M00730  | 4                             | 115 Supers            | 1 1/4"<br>M00727 | 10                     | 115 Frames            |

## Metal Rabbets

Metal Rabbets protect frame rests in your supers. Light gauge pre-punched and pre-bent metal parts fit over frame rests and nail into place. These metal parts increase the life of your supers and ease super cleaning by protecting the wooden frame rests during cleaning.

**M00722** Ship. wt. 25 per lb.

**M00722** L-Shaped Rabbet 1-99 ea. . . . . **\$31**

L-Shaped Rabbet 100-999 ea. . . . . **\$.26**

L-Shaped Rabbet 1000 & over ea. . . . . **\$.21**

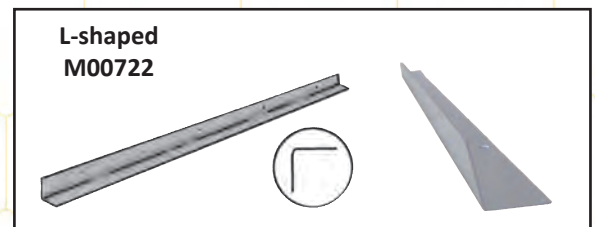

# 10-FRAME HIVE STANDS AND LANDING BOARDS



## Cypress Bottom Board with West Trap, Landing Board and IPM Board

This ultimate bottom board does it all. Made of Cypress this all-in-one bottom board will trap and kill SHB, allow you to check for mites with the IPM board, and give your bees a landing board to land on when coming back from foraging. Comes complete with west beetle trap and IPM board. Fully Assembled.

**M60040** 10-Frame Cypress Bottom Board, Ship wt. 6.5 lbs. . . . . \$41.15

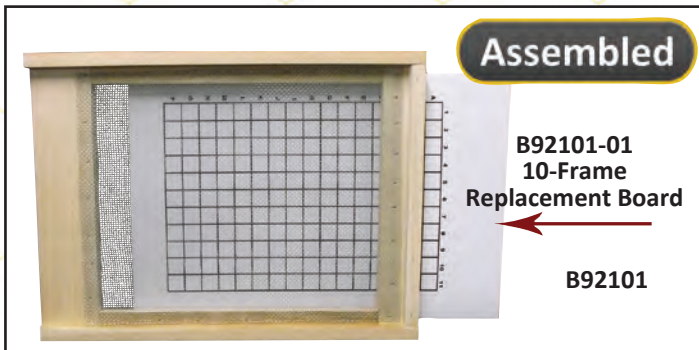

## Screen IPM Board

This integrated pest management bottom board comes complete with Varroa monitoring board. Access the screen from front of the hive below the bottom board. Leave the monitoring board out when not monitoring Varroa levels to provide extra ventilation and allow mites to fall through to the ground.

**B92101** 10-Frame, Ship wt. 3 lbs. ea. . . . . \$25.65  
5+ . . . . . \$23.30

## 10-Frame Replacement Boards

**B92101-01** Ship wt. 1 lb. ea . . . . . \$6.95  
5+ . . . . . \$6.65

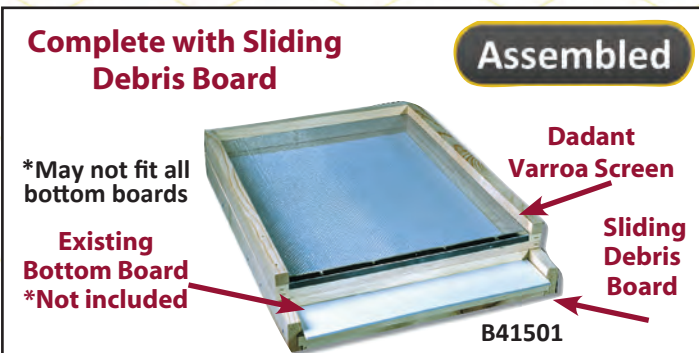

## Complete with Sliding Debris Board

\*May not fit all bottom boards

Existing Bottom Board  
\*Not included

## Dadant Wood Bound Varroa Screen

- Mites fall through the screen onto bottom board or debris tray to die if they fail to crawl up and find a honey bee.
- Monitor effectiveness of chemical treatments
- Bees can't get through the screen

**B41501** Dadant Wood Bound Varroa Screen, Ship wt. 4 lbs. ea. . . . . \$21.50

**M00934** Sticky Board (not included with Varroa Screen), Ship wt. 4 ozs. ea. . . . . \$4.05

- If more than 100 mites are caught naturally within a 48 hour period, a chemical treatment may be needed. Contact your state apiarist for guidelines.



## Ponderosa Pine Bottom Board

The standard 10-frame bottom board is the floor of the hive and is an essential part of the hive. It provides the hive entrance and proper spacing for the bees to work. Reversible feature allows full 3/4" summer entrance or 3/8" entrance when reversed for winter. Unassembled. (\*Nails included - standard only).

**B91101** Standard, c/1, Ship wt. 8 lbs . . . . . \$18.60\*

**B91105** Standard, c/5, Ship wt. 35 lbs. . . . . \$87.45\*

**B91201** Commercial, 50-249, Ship wt. 7lbs. . . . . \$12.25  
Commercial, 250+, Ship wt. 7 lbs . . . . . \$11.90

# 10-FRAME HIVE STANDS AND LANDING BOARDS



**Stainless steel**  
M00698

## Dadant Stainless Hive Stand

Dadant-made Stainless Steel Hive Stands sleek design is perfect for all types of apiaries. From a single hive operation to a 20 colony out yard, these stands are made to last. Ships knocked down. Easy to assemble. Ship wt. 8 lbs. ea.

**M00698** Dadant Stainless Hive Stand, ..... \$54.35

## AntCant

The AntCant™, ant barrier coating (patent pending) was scientifically developed to be a non-toxic, low maintenance deterrent from ant infestation. The coating works by preventing the ants from attaching to an inclined coated surface. Since they can't get a grip, they fall off and do not make it to the attractant (food, garbage, etc.) After being discouraged the ants give up and leave! Once the ants know the barrier is in place they don't seem to even re-challenge it! Includes 3.5 oz. bottle and a roll of 2" aluminum tape. Ship wt. 1 lb. ea.

**M001440** AntCant 3.5 oz. bottle ..... \$29.80



M01693

**Hive and frames not included**



Bee Max  
Hive Stand

M01696

## Ultimate Hive Stand Deluxe Model

The Ultimate Hive Stand Deluxe Model is the only hive stand you will ever need. It has a classic design that is fully functional and looks great in any apiary or garden. It has swing out frame holders to make working the hive easier and when not in use will fold up out of the way. The stand raises the hive 12 inches off the ground for easier access and better ventilation. It works with any bottom board and no wooden hive stand is needed. It is fast and easy to assemble, usually taking less than 2 minutes with a screwdriver. It is made from recycled materials.

**M01693** 10-frame Ultimate Hive Stand Deluxe Model, Ship wt. 10 lbs. ea. .... \$90.60

**M01696** 10-frame Beemax Deluxe Hive Stand, Ship wt. 10 lbs. ea. .... \$101.90



M00695

## Unassembled Hive Stand 10-Frame

To eliminate moisture problems and provide insulation, it is important to keep the hive from making contact with the ground. This durable wood hive stand protects the hive bottom board and gives bees an angled landing area. **Unassembled.**

**M00695** Ship wt. 5 lbs. ea. .... \$19.20  
**M00696** c/5, Ship wt. 18 lbs. .... \$83.80

## Slatted Rack

You asked for it and here it is. The slatted rack sits in between your bottom board and brood box, providing ventilation and extra space for the bees. The additional room provided when using the slatted rack is thought to help reduce swarming. Frames line up with the slats so varroa will fall through the screens in your bottom boards. Ship wt. 4 lbs. ea.

**B91401** 10-frame ..... \$22.10  
5+ ..... \$20.75



B91401

**Assembled**

# 10-FRAME TOP COVERS

## Telescoping Cover w/ Inner Cover

A strong, rigid cover with full thickness interlocking side rims. Interlocking ends are pre-drilled for easy handling. A heavy galvanized metal top has all four edges turned down to protect the edges of the wood. Metal top has pre-punched holes for nailing. This entire cover “telescopes” down over the inner cover and a portion of the top super. An inner cover is included. Unassembled. 10-Frame

- B11101** Ship wt. 13 lbs. ea. . . . . **\$40.25**
- B11105** C/5, Ship wt. 55 lbs. ea. . . . . **\$172.70**  
10+ C/5, Ship wt. 55 lbs. ea. . . . . **CALL**
- B10002** Metal Tops, 1-99, Ship wt. 3 lbs. ea. . . . . **\$11.85**  
Metal Tops, 100+, Ship wt. 3 lbs. ea. . . . . **\$10.65**
- C11001P** Assembled/Painted Tele Cover (only)  
Ship wt. 13 lbs. each . . . . . **\$36.10**

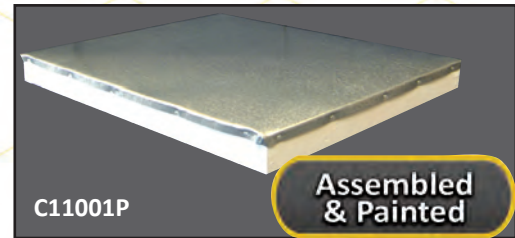

## BeeMax Style Insulated Telescoping Cover

(For wooden hives only)

The same style insulating cover used on our BeeMax Hive. For standard 10-frame Langstroth Hive. Upgrade your current wooden hive. Made of polystyrene, it is cooler in summer, warmer in the winter. Helps your honey bees in raising brood and collecting nectar instead of heating or cooling the hive. Ship wt. 5 lbs. ea

- M59301** 10-Frame 1-4 . . . . . **\$25.65 ea.**
- 5-49. . . . . **\$24.45 ea.**
- 50+. . . . . **\$22.10 ea.**



## Assembled Plywood Migratory Cover

Our plywood Migratory cover fits standard 10-frame boxes. No inner cover needed. Rim underneath provides the correct bee space and a place to feed pollen sub patties. Ship wt. 3 lbs.

- M60033** 10-Frame . . . . . **\$14.35**



## Unassembled Flat Wood Cover

The most economical commercial grade cover made from Ponderosa pine. Tongue and groove construction for a tight fit and a strong cover. *May not always be available at all locations.* Ship wt. 7 lbs.

- B14201** 10-Frame 1-49. . . . . **\$15.40 ea.**
- 50-249 . . . . . **\$14.35 ea.**
- 250+ . . . . . **\$13.00 ea.**

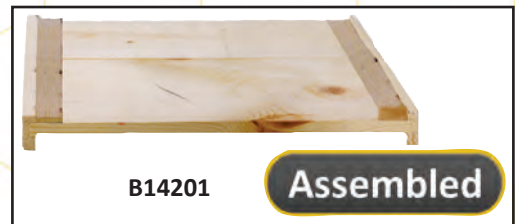

## Ultimate Hive Cover

The Ultimate Hive Cover is a self-ventilating, insulated, telescoping 10-frame cover. Made from recycled material, no assembly or painting required. Technopolymer construction will not rot. Double wall construction with dead air zone insulates the hive, cooler in summer and warmer in winter. Ship wt. 10 lbs. ea.

- M01605** 10-Frame . . . . . **\$39.60 ea.**
- M01605-08** Adaptor for 8-Frame. . . . . **\$2.99 ea.**



HIVE ACCESSORIES

# 10-FRAME INNER COVERS

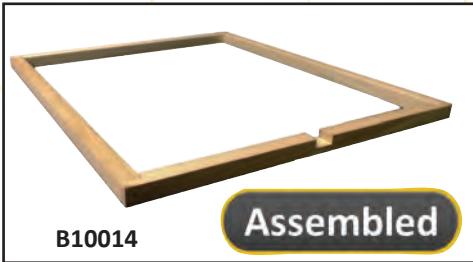

## Super Shim

The super shim is to be used only when your honey supers have been completely drawn out. Place shim above your queen excluder and below your honey super to give the bees an upper entrance / exit from the honey supers. *Note:* bees will burr comb the space from bottom of shim to bottom of super should you leave it on too long.

**B10014** 10-Frame Ship wt. 2 lbs. ea. .... \$4.90  
 5+ ..... \$4.60



## Assembled Inner Cover Only

Masonite Inner Cover - Mortise and tenon wood frame construction with sturdy masonite inner liner set in grooves. Will not shrink out of shape. Strong and durable. Designed to last a long time and work properly by providing correct bee working space and good hive ventilation. Use with bee escape to remove bees from supers. Ship wt. 4 lbs. ea

**B15201** 10-Frame ..... \$12.75  
**B15205** 10-Frame Ctn/5 1-9..... \$63.35  
 Ctn/5 10+ ..... CALL



## Assembled Ventilated Inner Cover

Use our vented inner cover to up honey production and increase ventilation throughout the hive. Ship wt. 1 lb. ea.

**B15501** 10-Frame ..... \$16.05 ea.



## Plywood Inner Cover w/ Feeder Hole

These inner covers work great to feed your colonies while keeping pesky critters including robbing bees away. Place an empty hive body on top to act as a shell and then your telescoping cover. Use a standard Boardman feeder cap in hole with a quart or 5 lb jar of syrup. Ship wt. 1 lb. ea.

**M60055** 10-Frame ..... \$14.20 ea.



## Clear Dome Cover 10-Frame

Clear Dome Cover for your beehive. This cover allows you to see the activity in the hive without having to open the hive. Perfect for visitors to see the active honey bees moving on the frames or feeding on a feeder in your hive. The people who are curious about the beehive but are nervous about the honey bees can see the action without disturbing the honey bees.

**M01610** 10-Frame ..... \$17.45



# 10-FRAME EXCLUDERS

## Wood Bound Excluder

The wood bound 10-frame excluder fits a standard hive. Electrically welded, precisely spaced metal wires make the grid system that is edged (bound) on all sides with quality fitted wood. Easy to use and remove. Provides proper bee spaces.

- B41101** 1 Wood Bound Excluder,  
Ship wt. 4 lbs. .... **\$18.60**
- B41110** 10 Wood Bound Excluders,  
Ship wt. 26 lbs. per 10 ..... **\$167.35**



**Assembled**



## Metal Bound Excluder

The metal bound excluder has the same precisely spaced welded wires as the wood bound excluder. This wire grid is edged (bound) with metal on all edges.

- M00823** 10-Frame  
1-9, Ship wt. 3 lbs. .... **\$8.60 ea.**  
10-499, Ship wt. 25 lbs./10 ..... **\$7.30ea.**  
500+, Ship wt. 25 lbs./10 ..... **\$6.70 ea.**

**For 8-Frames see page 32.**

Closeup of metal bound excluder construction. Heavy duty rivets to hold frame.

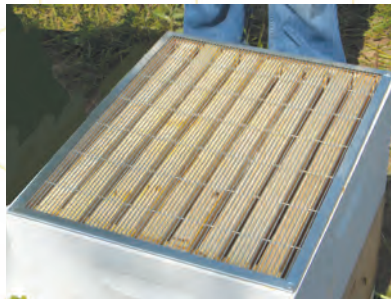

**Metal Bound Excluder shown on hive**



## Improved Plastic Excluder

This excluder is all plastic with properly sized openings for the worker bees to travel through. Flexible and durable. Easy to clean, corrosion proof.

- M00865** 10-Frame Ship wt. 8 ozs. ea,  
1-9 ..... **\$4.15**  
10-49 ..... **\$4.00**  
50-499 ..... **\$3.75**  
500+ ..... **\$2.95**

**For 8-Frames see page 32.**

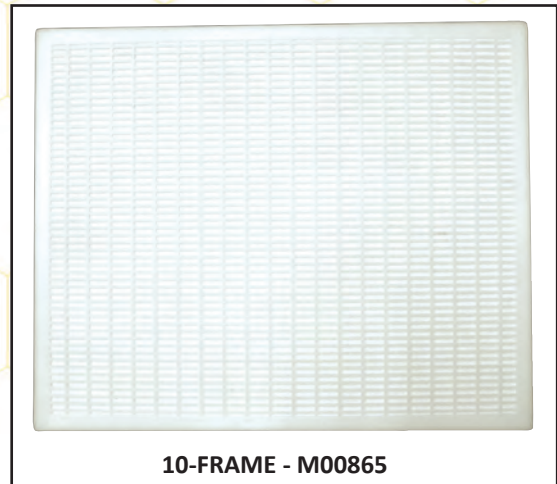

## Entrance Excluder

The entrance excluder will keep your queen and drone bees inside the hive. Useful tool when seeing hives preparing to swarm in the spring. Place entrance excluder on front of hive with nails (not included) to pin it in place. Use while installing new packages and during the winter as your mouse guard. Ship wt. 1 lb., ea.

- M60065** ..... **\$8.10**

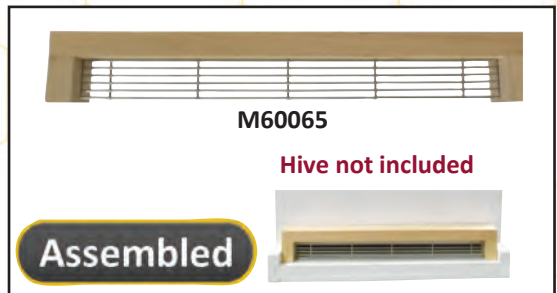

# 8- & 10-FRAME POLLEN AND PROPOLIS TRAPS

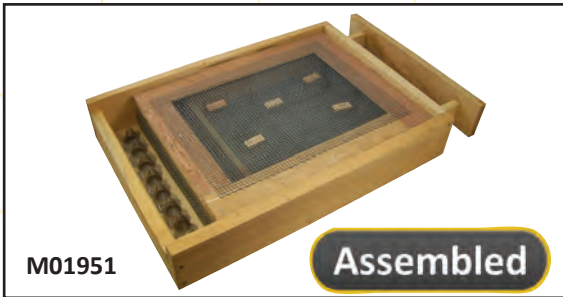

M01951

**Assembled**

## Pollen Trap 8-Frame

This top pollen trap is the finest top mount pollen trap being offered today. When ready to use, just place the trap directly over the top of your hive. A convenient sliding drawer at the rear of the hive makes ease out of removing pollen from the trap. All entrances must be closed for the bees to enter through the top of the pollen trap. Simple to set up, simple to use. Ship wt. 10 lbs. ea.

**\*CANNOT BE USED WITH EXCLUDERS\***

M01951 ..... \$72.05



M00690

**Assembled**

Side rails not shown on trap.

Rails

## Pollen Trap 10-Frame

Hive not included



Trap shown on hive

**Exterior Pollen Trap**—Our most popular trap. Four-sided frame fits between hive bodies. Trap fits on outside of hive. Colony is redirected into pollen trap. Simple and effective. Easy to use. Ship wt. 10 lbs. ea.

M00690 ..... \$46.30

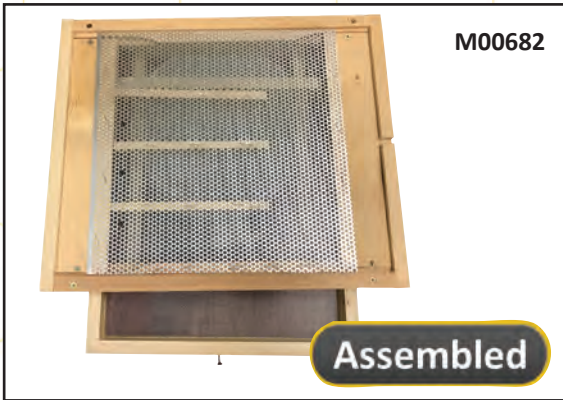

M00682

**Assembled**

## Bottom Pollen Trap 10-Frame

Hive not included



Trap shown on hive

**Bottom Pollen Trap** — A great bottom pollen trap. Long lasting with built-in drone escapes and a convenient side sliding pollen collection drawer. Easy to set up and easy to use. Ship wt. 10 lbs. ea.

M00682 1-4 ..... \$90.60  
5-19..... \$84.90  
20+ ..... \$83.80

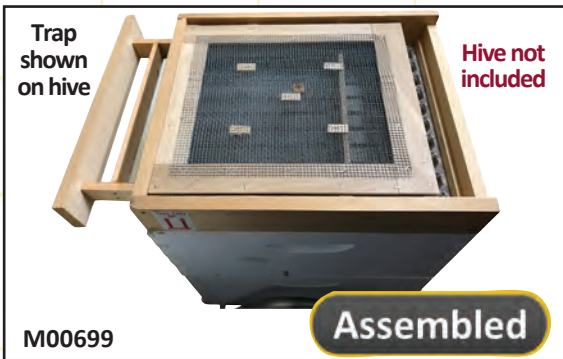

Trap shown on hive

Hive not included

**Assembled**

## Sundance II Pollen Trap 10-Frame

**Sundance II Pollen Trap**—We are pleased to offer a new approach to collecting pollen. The Sundance II top pollen trap is the finest top mount pollen trap being offered today. When ready to use, just place the trap directly over the top of your hive. A convenient sliding drawer at the rear of the hive makes it easy to remove pollen from the trap. All entrances must be closed for the bees to enter through the top of the pollen trap. Simple to set up, simple to use. Ship wt. 10 lbs. ea.

**\*CANNOT BE USED WITH EXCLUDERS\***

M00699 ..... \$87.50

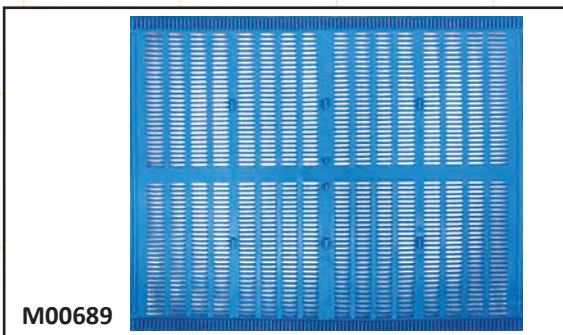

M00689

## Propolis Trap 10-Frame

**Propolis Trap**—Earn extra money collecting and selling propolis. Trap installs in place of inner cover. Once finished collecting propolis place trap in garbage bag and into deep freeze. Once frozen propolis will easily come off screen for you to collect and clean.

M00689 1-9, Ship wt. 1 lb. ea. .... \$9.00  
10-99, Ship wt. 10 lbs./10 ..... \$8.15  
100+, Ship wt. 93 lbs./100 ..... \$8.00

# 8-FRAME HIVE KITS

## Assembled Garden Hive with 9 $\frac{5}{8}$ " Brood Boxes

For those wishing to use larger brood chambers we have the 9 $\frac{5}{8}$ " depth 8-frame Dadant Garden Hive. Select grade wood is hand picked for these kits and assembled with ultimate care. Comes completely assembled with 8-frame copper garden cover, inner cover, two 9 $\frac{5}{8}$ " depth 8-frame brood boxes, 16 grooved top bar frames with plasticell foundation, solid bottom board and cedar hive stand.

**C52901**

9 $\frac{5}{8}$ " Assembled Garden Hive

**\$237.90**

*May not be available at all branch locations.*



## Assembled Garden Hive with 6 $\frac{5}{8}$ " Supers

We are pleased to offer the Dadant Garden Hive. Select grade wood is hand picked and assembled for your beekeeping adventure. This 8-frame garden hive will look wonderful in your flower garden or backyard. Comes completely assembled with copper garden top cover, inner cover, two 6 $\frac{5}{8}$ " supers, assembled frames with plasticell foundation, solid bottom board and cedar hive stand.

**C52801**

6 $\frac{5}{8}$ " Assembled Garden Hive

**\$233.15**

*May not be available at all branch locations.*



C52901

**PONDEROSA PINE LASTS LONGER**



C52801

# 8-FRAME BEGINNER'S KITS

## Unassembled 8-Frame Beginner's Kit

- 1 - 8-frame 9 $\frac{5}{8}$ " beehive
- 8 - 9 $\frac{1}{8}$ " grooved top bar frames
- 8 - Sheets plastic based foundation
- 1 - Bottom board
- 1 - Telescoping metal cover
- 1 - Inner cover
- 1 - Reversible entrance reducer
- 1 - Entrance feeder
- 1 - All purpose hive tool
- 1 - Hat Veil Pullover Combo
- 1 - Sting resistant gloves
- 1 - Bee smoker to calm bees
- 1 - Smoker fuel 1 lb.
- 1 - Book *First Lessons in Beekeeping*
- 1 - Assembly instructions



**8-Frame Beginner Kit** This 8-frame hive kit comes with everything you will need to start your first colony of bees except for the bees themselves. This kit comes knocked down for your assembly. As your colony grows you will need to add an additional brood box and honey supers.

**M59701** 8-Frame Beginner Kit, Ship wt. 35 lbs..... **\$226.00**



**PONDEROSA PINE LASTS LONGER**

## Unassembled 8-Frame Starter Kit

- 2 - 8-frame 6 $\frac{5}{8}$ " supers
- 16 - 6 $\frac{1}{4}$ " grooved top bar frames
- 16 - Sheets plastic based foundation
- 1 - Bottom board
- 1 - Telescoping metal cover
- 1 - Inner cover
- 1 - Reversible entrance reducer
- 1 - Entrance feeder
- 1 - All purpose hive tool
- 1 - Hat Veil Pullover Combo
- 1 - Sting resistant gloves
- 1 - Bee smoker to calm bees
- 1 - Smoker fuel 1 lb.
- 1 - Book *First Lessons in Beekeeping*
- 1 - Assembly instructions



**8-Frame Starter Kit** For ease of lifting we recommend the starter kit with 6 $\frac{5}{8}$ " depth 8-frame supers. Includes all you will need to get going in beekeeping except for the bees. Additional supers will be needed as your hive grows. Comes knocked down.

**M59801** 8-frame Starter Kit, Ship wt. 44 lbs. .... **\$237.90**

-- NO SUBSTITUTIONS OR PARTIAL RETURNS ON KITS --

# 8-FRAME BEEKEEPING EQUIPMENT



B52601

**Not Assembled**

## 8-Frame Complete Hive *without foundation*

- Superbly constructed 9 $\frac{5}{8}$ " Select Grade Ponderosa Pine Hive Body
- Bottom Board with Reversible Reducer for summer and winter bee entrance
- 8 - 9 $\frac{5}{8}$ " Wedged Top Bar Frames
- Wood Entrance Reducer
- Inner Cover

**PONDEROSA PINE LASTS LONGER**

**Nails included for all components.**

**Notice:** Select Wood may not be available in all branch locations.

B52601 Carton of 1, Ship wt. 30 lbs. . \$94.00 ea.

## UNASSEMBLED 8-FRAME SUPERS

### 8-Frame 9 $\frac{5}{8}$ " DEEP SUPERS

| Wood Grade<br>(see page 4) | Quantity (Nails Not Included - See page 20) |  |  |  |   |
|----------------------------|---|--|--|--|---|
|                            | 1-4   | 5-10                                       | 11-49                                      | 50-249                                     | 250 - 499                               |
| <b>Select</b>              | B50231<br>Ship wt. 8.5 lbs. ea.<br>\$23.30  | B50231<br>Ship wt. 8.5 lbs. ea.<br>\$22.80 | B50231<br>Ship wt. 8.5 lbs. ea.<br>CALL    | B50231<br>Ship wt. 8.5 lbs. ea.<br>CALL    | B50231<br>Ship wt. 8.5 lbs. ea.<br>CALL |
| <b>Commercial</b>          | B50271<br>Ship wt. 8.5 lbs. ea.<br>\$19.80  | B50271<br>Ship wt. 8.5 lbs. ea.<br>\$18.65 | B50271<br>Ship wt. 8.5 lbs. ea.<br>\$17.45 | B50271<br>Ship wt. 8.5 lbs. ea.<br>\$16.35 | B50271<br>Ship wt. 8.5 lbs. ea.<br>CALL |

For quantities of 500+ Call for price



**Not Assembled**



### 8-Frame 6 $\frac{5}{8}$ " HONEY SUPERS

| Wood Grade<br>(see page 4) | Quantity (Nails Not Included - See page 20) |  |  |  |                                       |
|----------------------------|---|--|--|--|---------------------------------------|
|                            | 1-4   | 5-10                                     | 11-49                                    | 50-249                                   | 250 - 499                             |
| <b>Select</b>              | B31501<br>Ship wt. 6 lbs. ea.<br>\$20.35    | B31501<br>Ship wt. 6 lbs. ea.<br>\$18.05 | B31501<br>Ship wt. 6 lbs. ea.<br>CALL    | B31501<br>Ship wt. 6 lbs. ea.<br>CALL    | B31501<br>Ship wt. 6 lbs. ea.<br>CALL |
| <b>Commercial</b>          | B34000<br>Ship wt. 6 lbs. ea.<br>\$16.25    | B34000<br>Ship wt. 6 lbs. ea.<br>\$15.05 | B34000<br>Ship wt. 6 lbs. ea.<br>\$12.75 | B34000<br>Ship wt. 6 lbs. ea.<br>\$11.65 | B34000<br>Ship wt. 6 lbs. ea.<br>CALL |

For quantities of 500+ Call for price



**Not Assembled**



### 8-Frame 5 $\frac{1}{16}$ " SHALLOW SUPERS

| Wood Grade<br>(see page 4) | Quantity (Nails Not Included - See page 20) |  |  |  |                                       |
|----------------------------|---|--|--|--|---------------------------------------|
|                            | 1-4   | 5-10                                     | 11-49                                    | 50-249                                   | 250 - 499                             |
| <b>Select</b>              | B32501<br>Ship wt. 5 lbs. ea.<br>\$19.80    | B32501<br>Ship wt. 5 lbs. ea.<br>\$18.10 | B32501<br>Ship wt. 5 lbs. ea.<br>CALL    | B32501<br>Ship wt. 5 lbs. ea.<br>CALL    | B32501<br>Ship wt. 5 lbs. ea.<br>CALL |
| <b>Commercial</b>          | B34300<br>Ship wt. 5 lbs. ea.<br>\$16.25    | B34300<br>Ship wt. 5 lbs. ea.<br>\$15.05 | B34300<br>Ship wt. 5 lbs. ea.<br>\$12.75 | B34300<br>Ship wt. 5 lbs. ea.<br>\$11.65 | B34300<br>Ship wt. 5 lbs. ea.<br>CALL |

For quantities of 500+ Call for price



**Not Assembled**



**Assembled  
Hive Body Only**

We are offering three sizes of 8-frame boxes, assembled without frames and foundation. Made of NW Ponderosa pine, all wooden supers have tapered cut handholds for easy gripping, uniform interlocking joints to prevent cracks, and interlocking construction for superior strength.

**5 $\frac{1}{16}$ "  
Shallow  
Super**

Assembled  
without frames  
& foundation



C32501 Select 5 $\frac{1}{16}$ " Shallow Super  
Ship wt. 5 lbs. ea.  
Carton of 1 . . . . . \$23.30 ea.  
Carton of 5+ . . . . . \$21.90 ea.

**6 $\frac{5}{8}$ "  
Honey Super**

Assembled  
without frames  
& foundation



C315018 Select 6 $\frac{5}{8}$ " Honey Super  
Ship wt. 6 lbs. ea.  
Carton of 1 . . . . . \$25.60 ea.  
Carton of 5+ . . . . . \$24.45 ea.

**9 $\frac{5}{8}$ "  
Deep Super**

Assembled  
without frames  
& foundation



C50231 Select 9 $\frac{5}{8}$ " Deep Super  
Ship wt. 9 lbs. ea.  
Carton of 1 . . . . . \$27.95 ea.  
Carton of 5+ . . . . . \$25.10 ea.

# 8-FRAME BOTTOM BOARDS AND TOP COVERS



## Cypress Bottom Board with West Trap, Landing Board and IPM Board

This ultimate bottom board does it all. Made of Cypress this all in one bottom board will trap and kill SHB, allows you to check for mites with the IPM board, and gives your bees a landing board to land on when coming back from foraging. Fully Assembled. 8-frame bottom board is a modified 10-frame bottom board. It will have larger outer dimensions than your 8-frame equipment.

**M60045** 8-Frame Cypress Bottom Board, Ship wt. 4.5 lbs. .... \$41.90

### Screen IPM Board

This integrated pest management bottom board comes complete with varroa monitoring screen. Access the screen from front of the hive below the bottom board. Leave the screen out when not monitoring varroa levels to provide extra ventilation and allow mites to fall through to the ground. Ship wt. 3 lbs. ea.,

**B921018** 8-Frame Screen IPM Board ..... \$25.60

5+ ..... \$23.30

**B921018-01** 8-Frame Replacement Boards

Ship wt. 1 lb. ea ..... \$6.95

5+ ..... \$6.65



### Assembled 8-Frame Solid Bottom Board

Our 8-frame assembled solid bottom board will give you years of service. Made of the finest North Western Ponderosa Pine. 1 Wood Entrance Reducer (B93201) is included. Ship wt. 8 lbs. ea.

**C91301** 8-Frame Solid Bottom Board ..... \$22.20



### Assembled 8-Frame Telescoping Cover

Fully assembled 8-frame telescoping cover with heavy galvanized metal top. This entire cover "telescopes" over the inner cover and a portion of the top super. Inner cover sold separately. Ship wt. 7 lbs. ea.

**C11501** 8-Frame Telescoping Cover ..... \$30.35

5+ ..... \$27.95

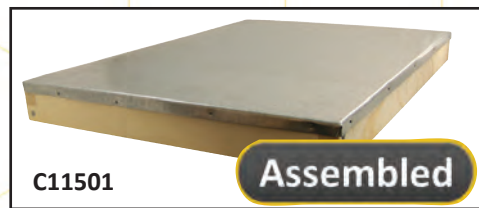

### Garden Copper Top Cover

We are pleased to offer the Dadant 8-frame Garden Copper Top. It is made of the finest materials available. *Please note that we will not accept returns of the copper tops due to scratches or spots caused by touching the copper. May not be available at all branch locations.*

Ship wt. 17 lbs. ea

**C12601** Garden Copper Top Cover ..... \$89.45

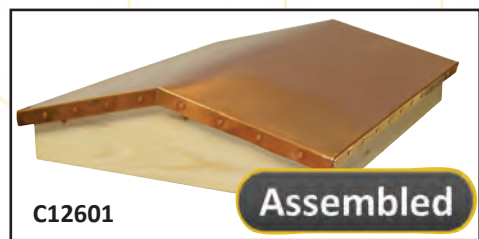

### Clear Dome Cover 8-Frame

Clear Dome Cover for your beehive. This cover allows you to see the activity in the hive without having to open the hive. Perfect for visitors to see the active honey bees moving on the frames or feeding on a feeder in your hive. The people who are curious about the beehive but are nervous about the honey bees can see the action without disturbing the honey bees.

**M016108** 8-Frame Clear Dome Cover ..... \$17.45



# 8-FRAME INNER COVERS



## Assembled 8-Frame Inner Cover

Masonite inner cover is strong and durable. Use with bee escape to clear bees from honey supers. Ship wt. 3 lbs. ea.

**B15601** 8-Frame Inner Cover ..... \$15.15



## Assembled 8-Frame Ventilated Inner Cover

Use our fully assembled 8-frame ventilated cover to help with ventilation and increase honey production. Ship wt. 1 lb. ea.

**B17501** 8-Frame Ventilated Inner Cover ..... \$16.05

**PONDEROSA PINE LASTS LONGER**



## Plywood Inner Cover with Feeder Hole

These inner covers work great to feed your colonies while keeping pesky critters including robbing bees away. Place an empty hive body on top to act as a shell and then your telescoping cover. Use a standard Boardman feeder cap in hole with a quart or 5 lb. round container of syrup. Ship wt. 1 lb.

**M60050** 8-Frame Plywood Inner Cover ..... \$14.20



## Super Shim

The super shim is to be used only when your honey supers have been completely drawn out. Place shim above your queen excluder and below your honey super to give the bees an upper entrance/exit from the honey supers. *Note:* bees will burr comb the space from bottom of shim to bottom of super should you leave it on too long. Ship wt. 2 lbs. ea

**B100148** 8-Frame Super Shim ..... \$4.90  
5+ ..... \$4.60

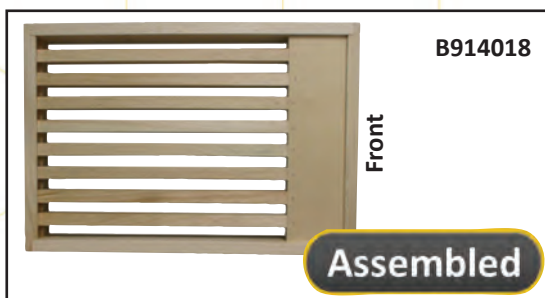

## Slatted Rack

You asked for it and here it is. The slatted rack sits in between your bottom board and brood box, providing ventilation and extra space for the bees. The additional room provided when using the slatted rack is thought to help reduce swarming. Frames line up with the slats so varroa will fall through the screens in your bottom boards. Ship wt. 4 lbs. ea.

**B914018** 8-Frame Slatted Rack ..... \$22.10  
5+ ..... \$20.75

# 8-FRAME EXCLUDERS AND STANDS

## Metal Bound Excluder

The metal bound excluder has the same precisely spaced welded wires as the wood bound excluder. This wire grid is edged (bound) with metal on all edges.

**M00893** 8-Frame Metal Bound Excluder, Ship wt. 3 lbs. . . . . \$8.60 ea.

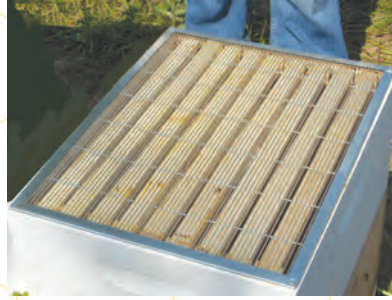
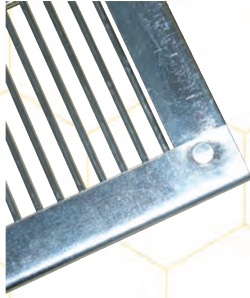

## Improved Plastic Excluder

This excluder is all plastic with properly sized openings for the worker bees to travel through. Flexible and durable. Easy to clean, corrosion proof. Ship wt. 8 ozs. ea.

**M008658** 8-Frame Plastic Excluder

|                  |        |
|------------------|--------|
| 1-9 . . . . .    | \$4.15 |
| 10-49 . . . . .  | \$3.80 |
| 50-499 . . . . . | \$3.40 |
| 500+ . . . . .   | \$2.95 |



## Dadant Stainless Hive Stand

Dadant-made Stainless Steel Hive Stands sleek design is perfect for all types of apiaries. From a single hive operation to a 20 colony out yard, these stands are made to last. Ships knocked down. Easy to assemble.

**M00698** 8-Frame Stainless Steel Hive Stand, Ship wt. 8 lbs. . . . . \$54.35

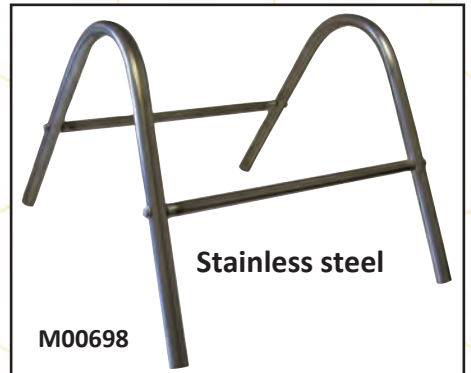

## Ultimate Hive Stand Deluxe Model *NEW STYLE!*

The Ultimate Hive Stand Deluxe Model is the only hive stand you will ever need. It has a classic design that is fully functional and looks great in any apiary or garden. It has swing out frame holders to make working the hive easier and when not in use will fold up out of the way. The stand raises the hive 12 inches off the ground for easier access and better ventilation. It works with any bottom board and no wooden hive stand is needed. It is fast and easy to assemble, usually taking less than 2 minutes with a screwdriver. It is made from recycled materials.

**M01694** 8-Frame Ultimate Hive Stand, Ship wt. 10 lbs. . . . . \$90.60



## AntCant

The AntCant™, ant barrier coating (patent pending) was scientifically developed to be a non-toxic, low maintenance deterrent from ant infestation. The coating works by preventing the ants from attaching to an inclined coated surface. Since they can't get a grip, they fall off and do not make it to the attractant. Includes 3.5 oz. bottle and a roll of 2" aluminum tape.



**M001440** AntCant  
Ship wt. 1 lb. ea. . . . . \$29.80

## Assembled 8-Frame Cedar Hive Stand

Our 8-frame Cedar hive stand will keep your bottom boards up and off the ground and give you years of service. Both solid and screened bottom boards will work with these. Ship wt. 5 lbs. ea.

**C02305** 8-Frame Cedar Hive Stand . . . . . \$18.60





# BEE MAX HIVE

A BeeMax Hive lets your bees spend more time raising brood and collecting nectar instead of heating or cooling the hive.

## The Best Bee Insulation Your Money Can Buy!

A complete Assembled Unit Contains:

- 1 - Hive Cover
- 1 - BeeMax Inner Cover
- 1 - Standard Hive Body
- 10 - Standard Wood Assembled Frames w/Plasticell Foundation
- 1 - Ventilated Bottom Board

or you can purchase the components separately!

### ~ Features ~

- ✓ Durable
- ✓ Proven Design and Testing
- ✓ Expert North American Construction
- ✓ Well-Ventilated
- ✓ Cooler in Summer
- ✓ Warmer in Winter



M01696

Hive and frames not included

We recommend painting your hive and super on the outside only and with latex paint.



M58851

### BeeMax Deluxe Hive Stand

M01696 10-Frame for BeeMax Hive  
Ship wt. 10 lbs. ea. . . . . \$101.90

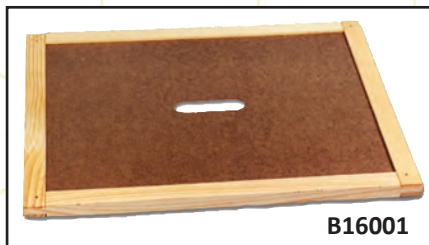

B16001



M59501

- M58851 Complete Assembled Unit, Ship wt. 37 lbs., ea. . . . . \$113.25
- M58901 Bottom, Ship wt. 4 lbs. ea.
  - 1-4 . . . . . \$25.70
  - 5-49 . . . . . \$21.60
  - 50+ . . . . . \$19.50
- M58801 Hive Body (Empty), Ship wt. 6 lbs. ea.
  - 1-4 . . . . . \$30.85
  - 5-49 . . . . . \$27.75
  - 50+ . . . . . \$23.50
- M59101 6 3/8 Super (Empty), Ship wt. 4 lbs. ea.
  - 1-4 . . . . . \$24.65
  - 5-49 . . . . . \$22.60
  - 50+ . . . . . \$20.70

- M59001 BeeMax Hive Cover, Ship wt. 5 lbs. ea.
  - 1-4 . . . . . \$25.30
  - 5-49 . . . . . \$24.65
  - 50+ . . . . . \$23.65
- B16001 BeeMax Inner Cover, Ship wt. 4 lbs. ea.
  - 1-4 . . . . . \$14.95
  - 5-24 . . . . . \$13.50
  - 25+ . . . . . \$11.95
- M59501 Entrance Feeder Complete, Ship wt. 2 lbs. ea. (use with BeeMax Hive only)
  - 1-49 . . . . . \$8.20
  - 50+ . . . . . \$7.85
- M01696 10-frame Beemax Deluxe Hive Stand, Ship wt. 10 lbs. ea. . . . . \$101.90

### BeeMax Hive Kit

BeeMax Hive Kit contains everything necessary for the beginner to start that first colony of bees, except the bees themselves.

#### Kit includes:

- 1 - Insulated BeeMax Hive
- 1 - Ventilated, Screened Bottom Board
- 10 - Standard Wood Assembled Frames w/Plasticell Foundation
- 1 - Alexander Veil
- 1 - Telescoping BeeMax Hive Cover
- 1 - BeeMax Inner Cover
- 1 - BeeMax Entrance Feeder
- 1 - All Purpose Hive Tool
- 1 - Bee Smoker to calm bees
- 1 - Smoker Fuel 1 lb.
- 1 - Sting Resistant Gloves
- 1 - Book *First Lessons in Beekeeping*
- 1 - Assembly Instructions

M58800 BeeMax Hive Kit, Ship wt. 60 lbs. . . . . \$226.55



Prolonged contact with Paradichlorobenzene (moth crystals) may damage BeeMax products

— NO SUBSTITUTIONS OR PARTIAL RETURNS ON KITS —

# WORLD'S BEST BEE SMOKERS

**COPIED BY MANY - BUT MATCHED BY NONE**

**Premium Smokers • Excellent Smoke Output • Superior Bellows Design**



**M00926**

**M00926** 4x7 Stainless Steel Smoker,  
Ship wt. 3 lbs. ea. . . . . \$37.05



**M00927 *\*\*Best Value\*\****

**M00927** 4x7 Stainless Steel Smoker with Shield,  
Ship wt. 3 lbs. ea. . . . . \$45.25

## “The Design That Works”

Dadant bee smokers are still *Made in the U.S.A. by us.*  
Don't settle for less than the best, in the original  
fashion of the Bingham smoker.

These smokers are of the original Bingham design that is of time proven quality. Dadant has been manufacturing these smokers since they acquired the A.G. Woodman company in the 1970's, and are proud to produce the smoker that everyone tries to duplicate.



**4 Models**

### Smoker Bellows Replacements



**M008041**

Reverse side

- *Flexible, tough Naughehyde fabric*
- *New face boards hold staples firmly*
- *Aluminum easy-grip edging*
- *Air valve for best operation*

**M008041** 4-Bolt Replacement Bellows,  
Ship wt. 1 lb. ea. . . . . \$16.45



**M00928**

**M00928** 4x10 Stainless Steel Smoker with Shield,  
Ship wt. 4 lbs. ea. . . . . \$47.35



**M009281**

**M009281** 4x10 Stainless Steel Smoker with Shield  
(Finger Heat Guard),  
Ship wt. 4 lbs. ea. . . . . \$49.40



M01944

**Domed Smoker**

Don't be fooled by the other guys' high priced imported smokers. If you are looking for a decent smoker at a discount price, this is the smoker for you.

M01944 4 x 7 Domed Smoker,  
Ship wt. 3 lbs. ea. .... \$28.25



M019441

**Replacement Bellows  
for M01944 Domed Smoker**  
Imported domed smoker bellows

M019441 Domed Smoker Bellows,  
Ship wt. 1 lb. ea. .... \$13.55



M02210

**Jute Burlap Roll - Smoker Fuel**

The Jute Burlap Roll makes a great smoker fuel. Easy to ignite and produces a light cool smoke. Unrolls for easy use and storage. Roll weighs 3.9 lbs.

M02210 Ship wt. 5 lbs. .... \$25.70



M00808

M008085

**-Fast Lighting-  
-Easy Use-**

**Wood Pellet Smoker Fuel**

**Wood Smoker Pellets**

- \* Long lasting smoke \*
- \* Makes your trip to the bee yard better \*
- \* Your smoker is always ready...  
when Smoker Pellets are used \*

**Recommended for Commercial Use**

M008085 5 lb. bag ..... \$5.75  
✕ M00808 40 lb. bag ..... \$13.90



**BEST  
VALUE**

M00810

**Smoker Fuel**

All cotton fibers make this the smoker fuel of choice. Can be easily lit with a match or lighter for a long continuous burn. Much easier to light than the plugs of the past. A simple solution to the never ending search for smoker fuel.

M00810 1 lb. package ..... \$4.50  
 5-39 lbs. .... \$4.05/lb

# ESSENTIAL HIVE TOOLS

## for working with Honey Bees



**9.5" Painted** M00757   
**9.5" Economy** M007571   
**9.5" Yellow** M00760   
**7.5" Small Yellow** M00761   
**J Hook** M00856   
**Italian** M01948   
**Turbo** M01953   
**6" Hive Tool** M01978

|                |   |                |
|----------------|---|----------------|
| <b>M00757</b>  | Painted Hive Tool, Ship wt. 6 ozs. ea.....            | <b>\$12.40</b> |
| <b>M007571</b> | Economy Hive Tool, Ship wt. 6 ozs. ea.                |                |
|                | 1-9 .....   | <b>\$5.60</b>  |
|                | 10+.....  | <b>\$5.40</b>  |
| <b>M00760</b>  | 9.5" Yellow Hive Tool, Ship wt. 5 ozs. ea. ....       | <b>\$15.40</b> |
| <b>M00761</b>  | 7.5" Small Yellow Hive Tool, Ship wt. 4 ozs. ea. .... | <b>\$13.35</b> |
| <b>M00856</b>  | J Hook Hive Tool, Ship wt. 5 ozs. ea. ....            | <b>\$11.30</b> |
| <b>M01948</b>  | Italian Hive Tool, Ship wt. 3 ozs. ea. ....           | <b>\$7.10</b>  |
| <b>M01953</b>  | Turbo Hive Tool, Ship wt. 7 ozs. ea. ....             | <b>\$20.10</b> |
| <b>M01978</b>  | 6" Hive Tool, Ship wt. 3 ozs. ea. ....                | <b>\$8.10</b>  |



**M01972**

### Multi-Purpose Tool

- Made of Hard Stainless Steel material and wooden handle.
- Hive Tool Functions include, J-Hook framer puller, scraper, frame cleaner, nail puller, queen bee excluder cleaner, pry bar, detachable hammer & more. Color may vary.

**M01972** Multi-Purpose Tool  
Ship wt. 4 ozs. ea. .... **\$16.45**

# HAND TOOLS AND FRAME SPACING TOOLS



M00889

## Mule Frame Grip

Little Mule frame grips are the top of the line. Holding both wooden or plastic frames these frame grips have a locking 1" arm that helps reduce hand strain. Get a grip on your frame with this durable stainless steel frame gripping device. Made in USA. Ship wt. 1 lb. ea

M00889 ..... \$28.80



M00754

## Frame Grip

Grips top bar of frame for loosening and removing frames from supers. Single spring allows one hand operation. Ship wt. 1 lb. ea

M00754 ..... \$25.10



M00748

## Round Handled Frame Grip

This frame grip is as tough as all the others, but at a portion of the cost. Rounded handles make for an easy grip. Ship wt. 1 lb. ea.

M00748 ..... \$11.65

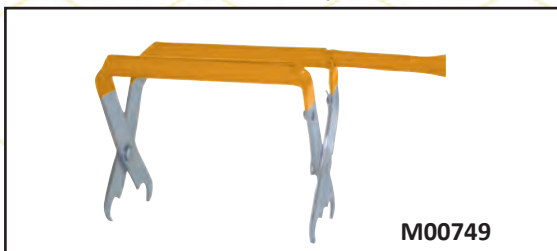

M00749

## Frame Grip

This handy tool, imported from Portugal, features a combination frame manipulation tool and frame grip all in one. Loosen the frame with the tool end then grip. Ship wt. 8 oz. ea.

M00749 ..... \$16.25



M00751

Soft, Flexible Bristles  
—Won't Injure Bees

## Bee Brush

The bee brush has long, soft, flexible yellow bristles that are gentle enough for brushing bees off queen cells yet firm enough to remove bees from frames, supers, or clothes. Will not crush or injure bees. A sturdy all purpose wooden handle brush. Can be washed. Ship wt. 8 ozs. ea

M00751 1-5 ..... \$6.75  
6+ ..... \$5.60

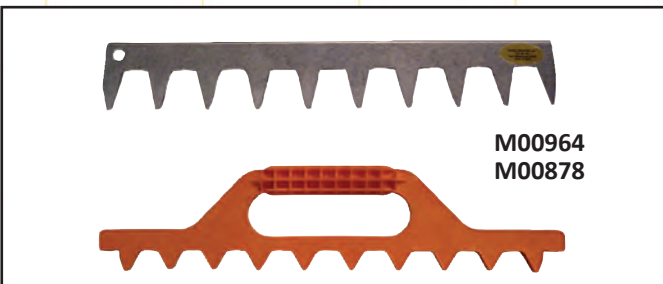

M00964  
M00878

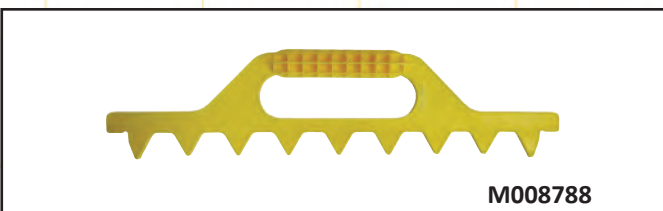

M008788

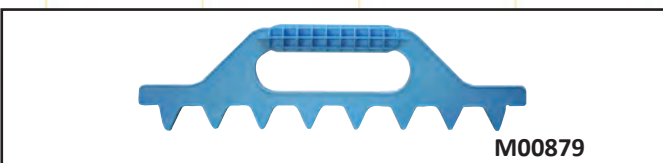

M00879

## 9-Frame Spacing Tools

9-frame spacing tools. These tools will easily space 9-frames in a 10-frame honey super. The bees will extend the comb beyond the edge of the frame making uncapping easier and quicker. Available in stainless steel or plastic.

M00964 Stainless Steel 9-Frame Spacing Tool  
Ship wt. 4 ozs., ea. .... \$20.55

M00878 Plastic 9-Frame Spacing Tool  
Ship wt. 4 ozs., ea. .... \$14.35

## Plastic 8-Frame Spacing Tool

This tool will easily space 8-frames in a 10-frame honey super. The bees will extend the comb beyond the edge of the frame making uncapping easier and quicker.

M008788 Plastic 8-Frame Spacing Tool  
Ship wt. 4 ozs., ea. .... \$14.35

## Plastic 7-Frame Spacing Tool

This tool is used to space 7-frames in an 8-frame box.

M00879 Plastic 7-Frame Spacing Tool  
Ship wt. 4 ozs., ea. .... \$14.35

# BEEHIVE MOVING ACCESSORIES

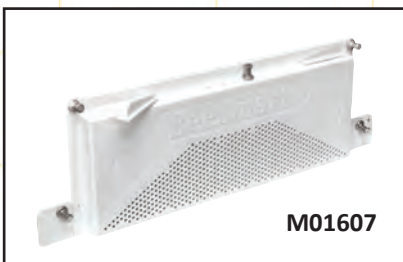

M01607

## Ultimate Universal IPM Robber Screen

Brought to you by Bee Smart this robbing screen works well on most 8- and 10-frame bottom boards. Cutting the screen down to fit correctly on some styles of bottom boards is needed. EZ installation with stainless push in pins. Great ventilation, UV protected. Ship wt. 1 lb. ea.

M01607 ..... \$9.95



Hive and stand not included

B93401

## Moving Robber Screen

A two-in-one tool. These screens can be left on all season long. Close the screen off to help cut down on weaker colonies being robbed and use the top exit, or close them off completely to move hives from one location to the next. Available in 8 and 10-frame. Ship wt. 1 lb. ea.

B93401 10-Frame ..... \$22.60

B934018 8-Frame ..... \$22.10



M00318

## Hive Carrier

Convenient tool to transport heavy hives or supers. Lets two people move a hive from the truck to the yard and move supers from the hive to the truck. Galvanized steel frame for durability. Designed for easy operation. **Hive sold separately.** Ship wt. 8 lbs. ea.

M00318 ..... \$90.60



M00735

Staples penetrate  $\frac{3}{4}$ ". Points 2" apart. Quick, easy way to fasten bottom board to hive body. Approx. 125 per lb.

M00735 per lb., Ship wt. 2 lbs. .... \$8.30

M00736 10 lbs., Ship wt. 13 lbs. .... \$71.35

M00737 50 lb., keg., Ship wt. 55 lbs. .... \$261.40

## Hive Staples

Call for Quantity Pricing

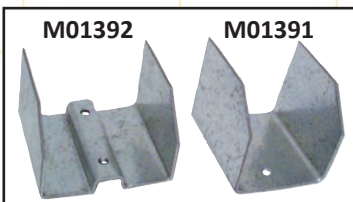

M01392

M01391

## Pallet Clips—2 Styles

Secure your hives to pallets with these clips. We offer both the W and U style.

Ship wt. 1 lb., ea

M01392 Pallet Clip - style W ..... \$ .93

M01391 Pallet Clip - style U ..... \$ .88



Close-up of closure

V02000

## Hive Net

For use when moving hives from yard to yard or to keep bees inside the colony due to herbicide spraying.

Ship wt. 2 lbs., ea.

V02000 ..... \$33.95

## Single Super/Hive Carrier



M00325

Convenient tool to transport heavy hives or supers. Lets one person move a super from the truck to the yard. Galvanized steel frame for durability. Designed for easy operation. **Hive sold separately.**

Ship wt. 8 lbs. ea.

M00325 ..... \$85.45



M01395

M01396

## Ratchet Straps

Unique shock absorbing tie down that incorporates three of the most versatile tie down principles into one superior system. Maintains constant tension and acts like shock absorbers keeping your load secure. Dependable, Durable, and Rust Resistant. Backed by manufacturer 2 Year warranty, this is the best tie down strapping on the market for your Bee Hives, Bobcats, or Hummer Bees.

M01395 10' Black Cam Strap, Ship wt. 1.45 lbs. .... \$29.15

M01396 18' Ratchet Strap, Ship wt. 4.5 lbs. .... \$51.45

## Black/Red Tie Down Strap

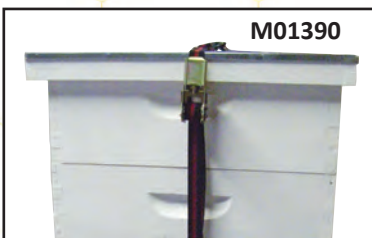

M01390

No nails, staples or ropes ever again! Easy-to-use tie down straps with tensioning buckle secures your beehive every time. No slipping — No worries!

Ship wt. 9 ozs. ea.

M01390 ..... \$10.25

# ENTRANCE REDUCERS, FRAME SPACERS, HOLDERS AND FIXERS

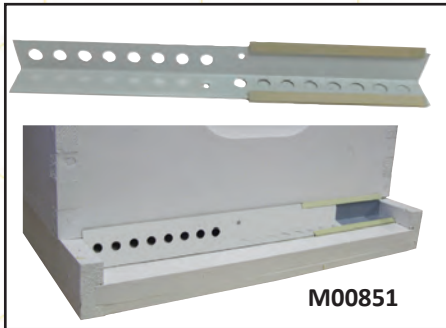

## Metal Entrance Reducer Original Galvanized

Quickly and easily installed on 10-frame hive. Fasten metal clips at both sides, slip reducer behind clips. Opening is 6" wide. Provides winter entrance. Keeps mice out. Screws included. Priced per set. Ship. wt. 4 ozs., ea.



**M00855** 1-11 sets, Ship wt. 12 ozs. ea. .... \$1.50  
 12-99 sets each ..... \$1.40  
 100+ sets each ..... \$1.25

## Universal Entrance Reducer

- Eight 3/8" entrance holes
- Made with durable 24 gauge baked-on metal
- Screw holes provided if you want to fasten to hive
- Mouse-proof

**M00851** Ship wt. 13 ozs. ea.  
 1-9 ..... \$3.75  
 10-49 ..... \$3.20  
 50-99 ..... \$3.10  
 100-499 ..... CALL  
 500+ ..... CALL

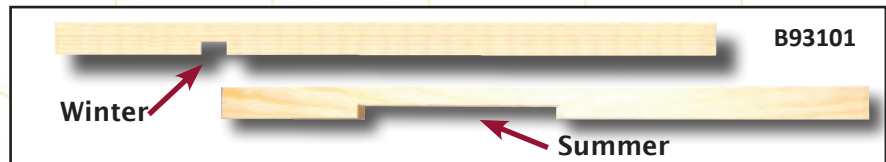

## Wood Entrance Reducer

The standard of the industry for 100 years. Two entrance/exit sizes. Small for winter and large for summer. *Hint:* Reduce the entrance size until your valuable package bees are established. For use with standard pine bottom boards.

**B93101** 10-Frame - Wood Entrance Reducer, Ship wt. 2 ozs., ea. .... \$1.85  
**B93201** 8-Frame - Wood Entrance Reducer, Ship wt. 2 ozs., ea. .... \$1.85



## Frame Fixer

Don't throw those valuable frame-comb combinations away because of a broken top bar end. Repair frame top bar ends with these 20 ga. galvanized frame fixers. Nails included.

**M00718** 1-99 ..... \$36  
 100-999 ..... \$31  
 1000+ ..... \$26  
 Ship wt. 1 oz., ea

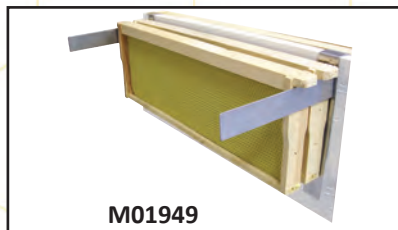

## Economy Frame Holder

This economy frame holder will do the trick at the right price. Place up to 3 frames at a time on our economy frame holder.

**M01949** Economy Frame Holder  
 Ship wt. 2 lbs. .... \$15.15

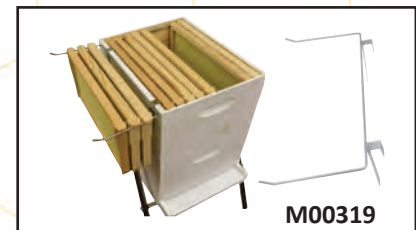

## Frame Holder

Why bend over and set frames on the grass, or try to balance them against the hive? With the Frame Holder, now your brood or honey filled frames are at your fingertips. Frame Holder, the most efficient and convenient way to hold valuable comb filled frames removed from the colony during inspection.

**M00319** Frame Holder  
 Ship wt. 3 lbs. .... \$25.70



## Metal Frame Spacer

Metal Frame Spacers are metal devices which have cutouts to receive the frames and space them evenly. They fit over the frame support area of hive bodies and supers of the 10 frame size. They are great time savers. They allow even spaces for the bees to fully draw combs and they protect frame rests. Ship wt. 2 ozs., ea

**M00874** 9-Frame Spacers  
 1-99, ea. .... \$82  
 100-499, ea. .... \$72  
 500+, ea. .... CALL

**M00875** 8-Frame Spacers  
 1-99, ea. .... \$82  
 100-499, ea. .... \$72  
 500+, ea. .... CALL

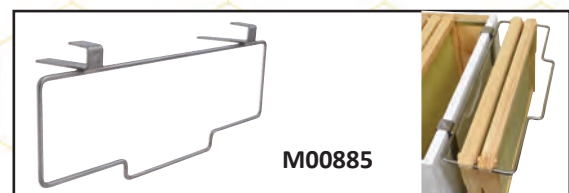

## Mule Grip Frame Holder

The little mule frame holder will accommodate 3 frames. Its all stainless design and tight fit makes sure your frames do not fall to the ground. Made in USA.  
 Ship wt. 1 lb. ea

**M00885** ..... \$30.55

# COMB HONEY PRODUCTION

## Honey In The Comb

### Learn How To Produce Comb Honey

By Eugene E. Killion. Twelve comprehensive chapters cover every aspect of comb honey production in both round and square sections. 165 brand new photographs and equipment drawings, completely cross-indexed. 148 pages, soft-bound in honey gold. Also, don't miss the DVD by Gene Killion complementing his book of the same title. An excellent guide and aid for the novice and experienced beekeeper alike.

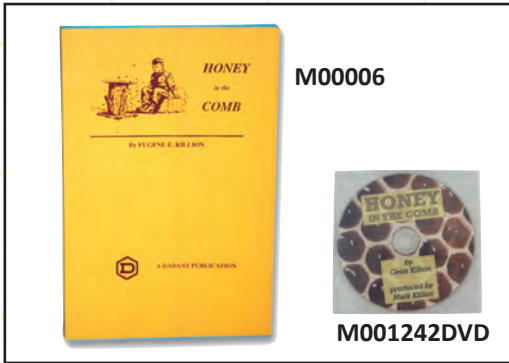

M00006



M001242DVD

- M00006 Honey in the Comb Book, Ship wt. 3 lbs. ea. .... \$10.80
- M001242DVD Honey in the Comb DVD, Ship wt. 4 ozs. ea. .... \$20.55
- M00006SET Honey in the Comb Book & DVD Set, Ship wt. 4 lbs. ea. .... \$30.40

## Wax Tube Fastener

**Wax Tube Fastener** is ideal for securing foundation into grooved top bar (cut comb and chunk honey) frames. Metal cylinder is filled with lowering into container of hot, liquid beeswax. When cylinder is filled, wax is retained in cylinder by placing finger over air hole. With foundation in place, the wax tube fastener is run along the top bar groove. By removing finger from the air hole, a small amount of wax flows out to cement the foundation to the top bar.



M00778

- M00778 Wax Tube Fastener, Ship wt. 5 ozs. ea. .... \$8.15

## Frame Cleaner

A handy tool to clean top or bottom groove of any style frame. Quickly removes wax and propolis from grooves. Especially useful for comb honey production.



M00753

- M00753 Frame Cleaner. Ship wt. 1 oz. ea. .... \$7.30



M00770

## Section Scraping Knife

This knife is specially designed and constructed for cleaning wax and propolis from finished sections. The notch in the top is ideal for edges — it prevents cutting into the honey.

- M00770 Section Knife, Ship wt. 3 ozs. ea. .... \$17.45



M00336

## Serrated Comb Honey Knife

The best comb cutting knife we have found. This extremely sharp and serrated knife makes slicing through comb a breeze. Total knife length 8.5" (blade length 4")

- M00336 Serrated Comb Honey Knife, Ship wt. 2 ozs. ea. .... \$14.70



M00937

## Comb Cutter

**Comb Cutter** —Cut 4 $\frac{1}{8}$ " x 4 $\frac{1}{8}$ " sections of comb honey to fit standard cut comb boxes, M00250, (see page 108). All food grade stainless steel. Sharpened cutting blade. Sturdy stainless steel handle. Made in the USA.

- M00937 Stainless Steel Comb Cutter, Ship wt. 6 ozs. ea. .... \$14.35



M00938

## Small Comb Cutter

**Small Comb Cutter** —Cut 3 $\frac{3}{4}$ " x 3 $\frac{3}{4}$ " sections of comb honey to fit, M00251, Economy Cut Comb Boxes (see page 110). All food grade stainless steel. Sharpened cutting blade. Sturdy stainless steel handle. Made in the USA.

- M00938 Stainless Steel Comb Cutter, Ship wt. 6 ozs. ea. .... \$14.35



# ROUND SECTION COMB HONEY

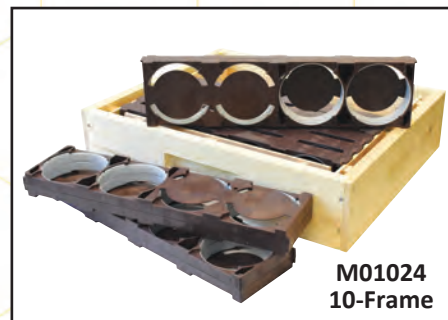

**M01024**  
10-Frame

## Component Parts for Round Section Comb Honey

- M01010** Half frames, carton of 36,  
(makes 72 round sections)  
Ship wt. 12 lbs. . . . . **\$101.90**
- M01013** 200 Section Rings,  
(2 per section required)  
Ship wt. 3 lbs. . . . . **\$63.40**
- M01014** 400 Section Rings,  
(2 per section required)  
Ship wt. 5 lbs. . . . . **\$102.70**
- M01015** 200 Clear Covers,  
(2 per section required)  
Ship wt. 8 lbs. . . . . **\$113.50**
- M01016** 400 Clear Covers,  
(2 per section required)  
Ship wt. 15 lbs. . . . . **\$213.95**
- M01022** 200 Opaque Covers,  
(2 per section required)  
Ship wt. 8 lbs. . . . . **\$113.50**
- M01017** 400 Opaque Covers,  
(2 per section required)  
Ship wt. 15 lbs. . . . . **\$210.85**
- M00953** 100 Round Section Labels  
Ship wt. 12 oz. . . . . **\$19.20**

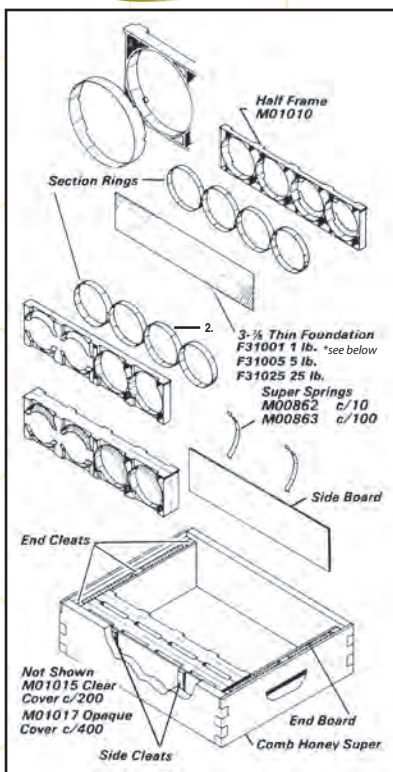

## Complete Round Section Super Ready to Use Except for Installing Foundation

Round Section Super is shipped assembled. Purchase foundation below, (item number **F31001**). Insert it between section half frames, and place super on the hive. Ship wt. 15 lbs. (Covers sold separately—See left hand column—Clear or opaque.)

- M01024** 10-frame ea. . . . . **\$128.70**
- M010248** 8-frame ea. . . . . **\$128.70**

Each portion of the foundation becomes a part of the comb honey for sale. We use the utmost care in selecting only the very finest of virgin capping wax for the manufacturing of our thin surplus foundation. The raw wax is then washed, cleaned and filtered so only **pure 100% beeswax** is present in the finished sheet of foundation. Strong sidewalls on each cell help your bees to finish beautiful sections of sparkling white comb honey.

## FOR CUT COMB & CHUNK HONEY PRODUCTION

We also recommend 4 $\frac{3}{4}$ " Thin Surplus and 4 $\frac{3}{4}$ " Cut Comb foundation. All of these products are listed on page 14.

| 5 $\frac{1}{16}$ " Comb Honey Supers — empty   | 5 $\frac{3}{8}$ " Frames   | 4 $\frac{3}{4}$ " Cut Comb Foundation   |
|--|--|---|
| <b>B32201</b> Carton of 1<br>Ship wt. 5 lbs. . . . . <b>\$19.80</b>  | <b>B77110</b> 10 Frames per Carton<br>Ship wt. 6 lbs. . . . . <b>\$15.85</b>                                       | <b>F32201</b> 1 lb. of Foundation<br>Ship wt. 2 lbs. . . . . <b>\$11.95</b>     |
| <b>B32205</b> Carton of 5<br>Ship wt. 30 lbs. . . . . <b>\$81.65</b>   | <b>B77150</b> 50 Frames per Carton<br>Ship wt. 25 lbs. . . . . <b>\$69.95</b>                                      | <b>F32205</b> 5 lbs. of Foundation<br>Ship wt. 7 lbs. . . . . <b>\$54.40</b>    |
| <b>B34400*</b> Commercial, Carton of 1<br>11-49 . . . . . <b>\$16.25</b><br>Ship wt. 5 lbs. ea.<br>(for larger quantities see page 17)<br>* Nails not included | <b>B85004*</b> 100 Bulk Frames, Commercial<br>Ship wt. 47 lbs./100 . . . . <b>\$115.70</b><br>* Nails not included | <b>F32200</b> 25 lbs. of Foundation<br>Ship wt. 31 lbs. . . . . <b>\$213.30</b> |
|  |  | Approximately 18 sheets per pound   |

## 100% Beeswax "Thin Surplus" Foundations for Round Comb Honey

Fits Round Section 3 $\frac{7}{8}$ " x 16 $\frac{1}{2}$ "

**F31001** Thin Surplus Foundation, 1 lb.  
(28 Sheets) Ship wt. 2 lbs. . . . . **\$13.15**

**F31005** Thin Surplus Foundation, 5 lbs.  
(140 Sheets) Ship wt. 7 lbs. . . . . **\$59.85**

**F31000** Thin Surplus Foundation, 25 lbs.  
(700 Sheets) Ship wt. 31 lbs. . . . . **\$213.30**

\*Sheets per carton are approximate and may vary in the manufacturing process.

# FEED CHART

| FEED ADDITIVES & SUPPLEMENTS    | METHOD OF APPLICATION  | TIME OF YEAR TO APPLY  |
|---------------------------------|--|--|
| <b>AP23 &amp; Brood Builder</b> | These pollen subs may be fed either dry or in patty form. If feeding patties and running double brood boxes, place patties between boxes. If running singles feed on top of frames.  | Feed in spring to boost colonies populations and in the fall after miticide treatments. May also be fed any time a pollen dearth occurs. |
| <b>Honey - B - Healthy</b>      | Mix 1-2 teaspoons per quart when fed in sugar syrup. Use up to four teaspoons when used as a spray with 1:1 syrup in place of a smoker to calm bees.   | Feed during late winter, early spring, fall or dearths of nectar and may also be used to build up nucs, weak colonies and swarms.        |
| <b>HBH Super Plus</b>           | Mix 1 tsp. per quart of various sugar water mixes which can be increased to 3 tsp per quart. For patties test effect of 1 tsp. per lb and adjust as needed.  | Best in Spring and Fall but can be used any time of year. Feed with Honey Supers removed.  |
| <b>HBH Vitamin B</b>            | Add ½ tsp. to each quart or liter of sugar water when feeding. If used in protein patties, add ½ tsp. per 3 lbs dry  | Best in Spring and Fall but can be used any time of year. Feed with Honey Supers removed.  |
| <b>Complete</b>                 | Feed Complete anytime you are feeding sugar syrup. Can be fed in syrup, by drench method and in nutritional supplement protein patties.  | Apply Complete whenever feeding is needed.   |
| <b>Nozevit Plus</b>             | 15-20 drops per colony mixed in ¼ quart sugar syrup or sprayed on frames. May be fed in pollen patties 20 drops per 1 pound.   | Use as a feed supplement two times in the spring and fall at 10 day intervals  |
| <b>Optima</b>                   | It is advised to mix 1 - 2 teaspoons of Optima per gallon of syrup when fed through preferred hive feeder. A 100 ml bottle will make 20 gallons of syrup. When feeding by drench method it is advised to mix 4 teaspoons per quart of syrup and drench at rate of ¼ quart or 10 - 12 ounces solution per colony 4 times at 4 days apart. When feeding in pollen patties ½ teaspoon of optima per lb of patty is recommended. | Whenever feeding is needed or bees are overstressed.   |
| <b>Sugar Syrup</b>              | For spring feeding mix 1 part sugar to 1 part water to stimulate foraging. For fall feeding mix 2 part sugar to 1 part water if not enough honey has been stored for winter.   | Apply when needed.   |

**Buy 1/2 or full truckloads Call 1-888-922-1293.**

**Minimum 48 Hour Notice Required**

Liquid feeds available for pick-up at Chico, Fresno, High Springs, Paris, Chatham, Frankfort, and Hamilton or for delivery to your location throughout the U.S.A.

|                  |                |
|------------------|----------------|
| Chatham, VA      | 1-800-220-8325 |
| Frankfort, KY    | 1-888-932-3268 |
| Hamilton, IL     | 1-888-922-1293 |
| Chico, CA        | 1-877-332-3268 |
| Fresno, CA       | 1-877-432-3268 |
| High Springs, FL | 1-877-832-3268 |
| Paris, TX        | 1-877-632-3268 |

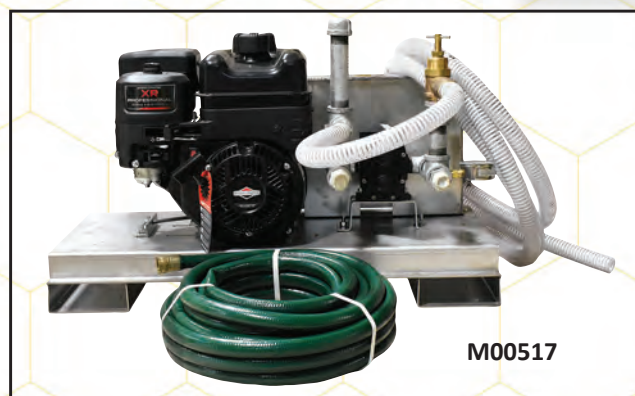

**Don't Carry It! Pump It with Dadant's Fructose Pump**

**Stainless Steel Fructose Pump**  
**Make Feeding Fructose Easy— Pump Directly From Storage Into Feeders**

- Pump 1 gallon 70° fructose in 15 seconds
- 5.5 hp 4 cycle B & S OHV gasoline engine
- Ball bearing output shaft
- 1" gear pump with pressure bypass system
- 14' crushproof suction hose
- 50' discharge hose and discharge nozzle

**M00517** Fructose Pump, Ship wt. 150 lbs. ea. . . . . **\$1,699.45**  
**Ships Freight Only**

# TOP FEEDERS

## Wooden Hive Top Feeder w/ Plastic Trough

Feeding your bees has never been easier. Our newly designed 8- and 10-frame top feeders are the ticket to get your bees up to weight. The 8 frame feeder will hold 2 gallons of syrup and our 10-frame model will accommodate 2.5 gallons of syrup. Sloped bottom ends of the feeder will feed syrup to the trough area when placed on level hives. Easy to read fill lines at the one and two gallon mark help you measure the right amount of syrup needed.

- M01436** 10-Frame, Ship wt. 9 lbs. ea. . . . . \$33.95
- M01435** 8-Frame, Ship wt. 9 lbs. ea. . . . . \$32.80

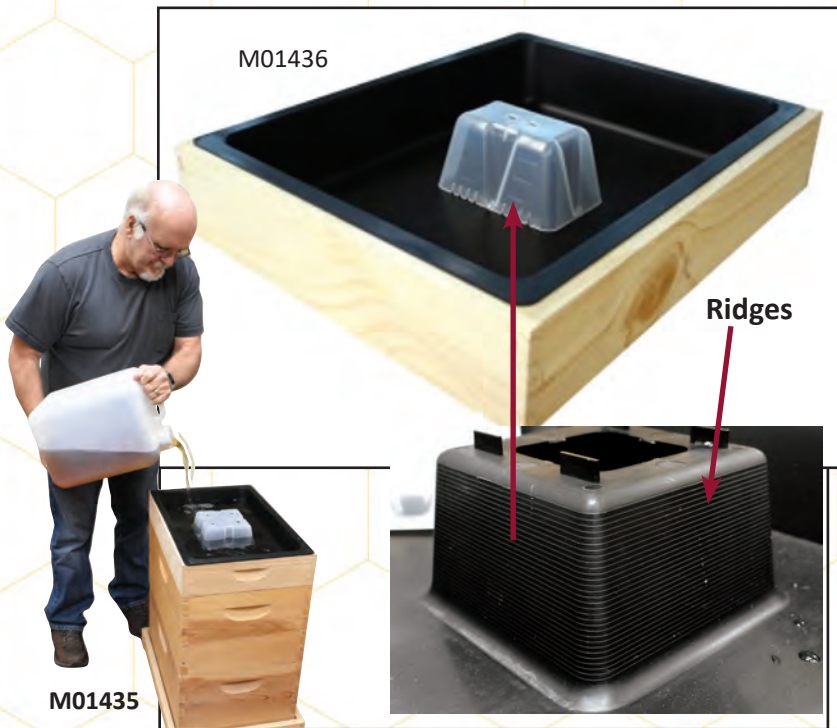

M01435



M01453

## Wooden Hive Top Feeder

This 8-frame wooden pine feeder is the best we have seen on the market. All joints are caulked with 100% silicone to ensure proper sealing and the bottom is made out of urethane coated maple plywood for durability against moisture. Wooden floats help keep drowned bees to a minimum. Ship wt. 9 lbs. ea.

- M01454** 10-Frame, Ship wt. 9 lbs. ea. . . . . \$29.80
- M01453** 8-Frame, Ship wt. 9 lbs. ea. . . . . \$30.85



M01452

## Easy Grip One Gallon Feed Can

The Easy Grip One Gallon feed can is made of high density polyethylene and molded here in the U.S.A. Replaces the older metal cans used by many commercial beekeepers. Come w/pre-punched lids. No need for paint as these won't rust.

- M01438** Ship wt. 1 lb. ea. . . . . \$10.15



M01438

## Wooden Nuc Top Feeder

This 5-frame pine nuc feeder is the best we have seen. All joints are caulked with 100% silicone to ensure proper sealing and the bottom is made out of urethane coated maple plywood for durability against moisture. Wooden floats help keep drowned bees to a minimum.

- M01452** Ship. wt. 7 lbs. ea. . . . . \$29.80

# BEE FEEDERS

## 4 Jar Feeder

This 4 jar feeder will keep you from having to refill jars every other day when introducing package bees or nucleus colonies. This will also come in handy when trying to get hives up to weight before winter. Place above inner cover hole and use a brood box as a shell. **Jars and lids not included.**

- M00825 Ship wt. 1 lb. ea. .... \$8.40
- M00887 Feeder Lid Only, Ship wt. lbs. ea. .... \$0.98



## Plywood Inner Cover w/ Feed Hole

These inner covers work great to feed your colonies while keeping pesky critters including robbing bees away. Place an empty hive body on top to act as a shell and then your telescoping cover. Use a standard Boardman feeder cap in hole with a quart or 5 lb jar of syrup. **Jar and lid not included.**

- M60055 10-Frame, Ship wt. 1 lb. ea. .... \$14.20
- M60050 8-Frame, Ship wt. 1 lb. ea. .... \$14.20

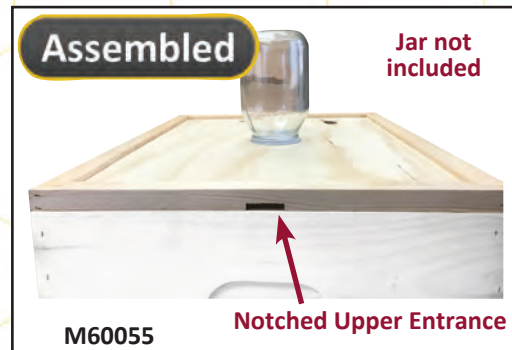

## Plywood 4 & 5 Frame Inner Cover w/ Feeder Hole

Our nuc inner cover is the same one that comes with our support hive. It works well with both 4- and 5-frame nuc boxes. Place empty nuc box on top of inner cover to act as a feed shell. Invert feed jar in hole. Standard G70 Boardman Feeder lid fits hole. **Jar and lid not included.**

- M60035-D Nuc Inner Cover w/Feeder Hole, Ship wt. 1.5 lbs. ea. .... \$11.65
- M00887 Feeder Lid Only, Ship wt. lbs. ea. .... \$0.98

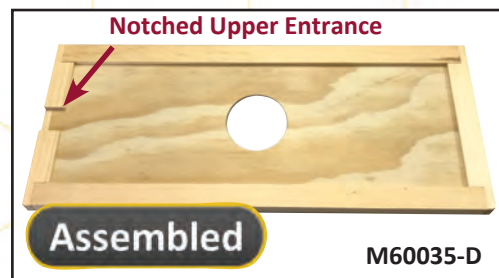

## Plywood Nuc Top Cover Only

This 5-frame nuc cover is fully assembled. G70 feeder cap fits the hole in the center and makes feeding your start up colonies a breeze. **PAINTING IS REQUIRED.**

- M60030 Plywood Top Cover only, Ship wt. 3 lbs. ea. .... \$11.60



## Feeder Jars - Glass 3 LB Quart Jar and 5 LB Round Jar

We have been using these 3 lb. quart and 5 lb. round jars as feed jars for many years. Easy to clean and refill, these can be used with our 4-jar feeder, our new plywood inner covers with feed hole and for your honey storage needs. Each jar makes a great container for honey and some use them exclusively for their payments to the landowner of the property the beekeepers hives are sitting on. It is also known as a yard rent jar. Both take a standard G70 closure.

- M001931 3 LB Jar Ship wt. ea. Carton/12 .... \$17.55
- M001921 5 LB Jar Ship wt. ea. Carton/6 ..... \$21.90
- M00887 Feeder Lid Only, Ship wt. lbs. ea. .... \$0.98



## Feeder Pail - 2 Gallon White Plastic Pail

These 2 gallon pails work well as feeder pails. When using as a feeder put 6-7 pin prick size holes in the center of the lid. Invert over the hole in the inner cover. This will give your bees easy access to the feed. Use an empty brood box as a shell to protect the hive from the elements. If punched holes are too large the syrup will not stay suspended. Lids come unpunched.

- M00238 Ship wt. 1 1/2 lbs. ea. 1-99 Pails ..... \$5.60
- 100+ Pails ..... \$5.40 ea.



# BEE FEEDERS

Frames/Hive/Nuc not included



Division Board Feeder placed in hive.

M00859

## Division Board Feeder

Finally a division board feeder that virtually eliminates drowned bees. **Heavily ribbed** interior gives bees a perfect foothold while climbing in or out. Extra thick sidewall construction puts more material where it's needed for years of use. Holds approx. 1 gallon. *Exclusive new condensation points—channels moisture away from feeder.* Fits 9 5/8" deep body hive Ship wt. 1 lb. ea.

M00859 Division Board Feeder

|                               |        |
|-------------------------------|--------|
| 1-4 .....                     | \$8.80 |
| 5-9 .....                     | \$6.65 |
| 10-49 .....                   | \$5.80 |
| 50-249 .....                  | \$5.00 |
| 250-499 .....                 | \$4.20 |
| 500+ Price— Call Local Branch |        |

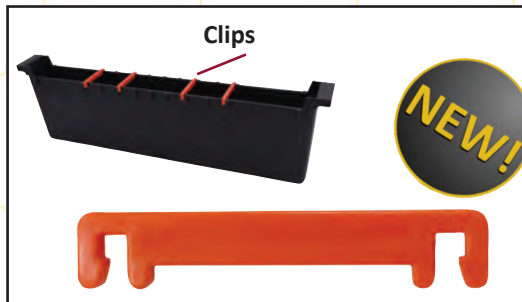

## Division Board Feeder Clips

M008591 ..... \$0.25



M01508

## Ultimate In-Hive Feeder

We are pleased to offer the "Ultimate In-Hive Feeder." Place feeder on top of brood box and use another empty super or brood box as a shell.

- Unique feeding tray prevents drowning
- Fits both 8- and 10-frame equipment
- Can be used with both medium and deep hive bodies
- Easy to clean, virtually maintenance free
- Made in USA

M01508 Ship wt. 1.5 lbs. ea. .... \$27.75



Fits 5 Gallon

Fits 2 Gallon

## Bucket Bee Raft (2 and 5 Gallon)

This is the easiest and fastest way we have found to feed sugar water to thriving colonies. Simply put sugar water into a prepared bucket and set the Bucket Bee Raft in place with the grooves up. This is not only a great way to feed bees but it's also great for watering bees as well. This is available in a two gallon and five gallon bucket size. A bucket prepared by scuffing with the included sandpaper, filled with sugar water, with the Bucket Bee Raft in place is considered a feeding station.

M014552 For 2 gallon bucket, Ship wt. 1 lbs. ea. .... \$12.95  
 M014555 For 5 gallon bucket, Ship wt. 1 lbs. ea. .... \$14.95



M01457

## EZ Nuc Feeder

The EZ Nuc feeder is just that EZ. The EZ feeder snaps into place on top of the Jester EZ nuc. Holds 2 quarts of sugar syrup. Ship wt. 1 lb. ea.

M01457 ..... \$9.25

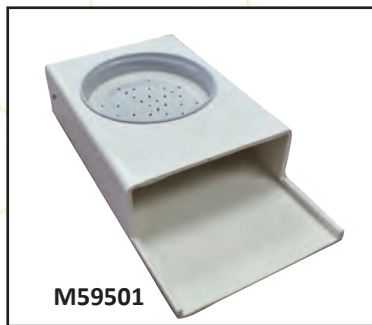

M59501

## BeeMax Entrance Feeder

All-weather PVC entrance feeder is custom designed for use with your BeeMax insulated hive. Perforated metal cap is included with each feeder. Cap fits standard mason jar. Ship wt. 2 lbs. ea.

M59501 ..... \$8.20

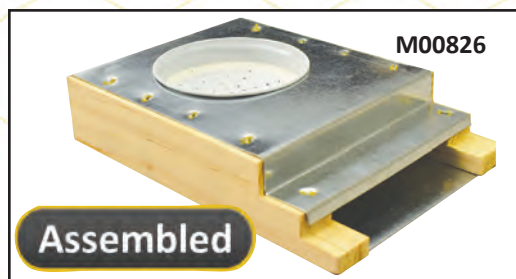

M00826

Assembled

## Entrance Feeder — for wood hives

Our Entrance Feeder fits snugly into the entrance of the colony. Works best in warm weather (late spring, summer, early fall). Perforated metal cap is included with each feeder. Cap fits standard mason jar. Feed level visible at all times. Refill jar without opening hive.

M00826 1-49 Ship wt. 9 ozs. ea. .... \$5.10  
 c/50 ea., Ship wt. 28 lbs. ... \$4.60  
 M00887 Replacement Cap Only (size G70), ea. .... \$ .98

# FEED ADDITIVES

## Nozevit plus

Nozevit Plus incorporates the original highly popular Nozevit product and adds additional whole plant polyphenols aimed at the longer term health of the honey bee while maintaining the same application rate and methodology. It is an all-natural product helping to promote and maintain the intestinal integrity of the honey bee along with the long-term health and vitality of your bees.

- M01955** - 50 ml, Ship wt. 1 lb..... \$25.70
- M01956** - 250 ml, Ship wt. 1 lb..... \$113.25
- M01958** - 1 liter, Ship wt. 3 lbs..... \$308.95

## Recommended feeding for Nozevit

- 1/4 quart or approximately 10 ounces of light syrup with 1 ml of nozevit or 20 drops
- Apply by either drenching or spraying syrup directly on top of frames in hive
- For preventive care we recommend feeding your bees two times, 10 days apart in spring, fall and during summer nectar dearths.
- For bees under extreme stress feed four times at 4 days apart
- Add to your pollen patties. 20 drops per pound or for the larger beekeeper 500 ml to 310 lbs. of dry product.
- Always store unused Nozevit in a cool dark location



- ◊ 50 ml bottle of Nozevit will feed 50 hives one time when mixed into 4 gallons or 15 liters of syrup
- ◊ 250 ml bottle of Nozevit will feed 250 hives one time when mixed into 22 gallons or 83 liters of syrup
- ◊ 500 ml bottle of Nozevit will feed 500 hives one time when mixed into 44 gallons or 167 liters of syrup
- ◊ 1000 ml bottle of Nozevit will feed 1000 hives one time when mixed into 88 gallons or 333 liters of syrup



## Complete

“Complete” contains full strength Nozevit, Optima and Bee Cleanse. The most “complete” food additive on the market containing more than 14 essential oils, amino acids, vitamins and minerals. One liter will feed up to 200 colonies by drenching or 400 colonies in sugar syrup.

**M01923** - 1 liter  
Ship wt. 2 lbs. ea. .... \$102.95

**M01935** - 5 gallon pail  
Ship wt. 57 lbs. ea.\* . . CALL  
**May not be available at all branch locations.**



Use as spray to work bees all season.  
**No Smoke!**  
Best quality we have found!

**M01922**

## Plastic Pump Sprayer

This is the best top quality pressurized pump sprayer we have ever run across. With a 1 liter capacity, it requires fewer fillings. Ideal for spraying a calming dose of **Honey-B-Healthy**. Add **Nozevit plus** to your spray and make the most of your colonies. See *Recipe*.

**M01922** Plastic Pump Sprayer, Ship wt. 2 lbs. ea. .... \$32.40

## Recipe

2 Heaping Tbs. Sugar  
2 Tbs. Honey-B-Healthy  
2 Tbs. Nozevit plus  
Mix with 1/2 sugar to 1 part water or 1:1 if a thicker spray is preferred. Makes 1-1/2 liters.



## Optima

Optima is a new all natural honey bee food supplement and feeding stimulant that is to be mixed into sugar syrup and pollen patties. It contains whole plant polyphenols known for their intestinal cleaning properties along with a complex essential oil package to help promote a healthy intestinal tract in the honey bee as well as overall hive health, vigor, productivity and cleanliness.

**Benefits:** Feeding stimulant, antibacterial for bees and hive components, calms bees when sprayed on them, queen acceptance, combining weak hives and swarms, encourages hygienic behavior.

**M01925** - 100 ml, Ship wt. 1 lb. .... \$15.40  
**M01926** - 500 ml, Ship wt. 2 lbs. .... \$51.45  
**M01927** - 1 liter, Ship wt. 3 lbs. .... \$92.65

## Honey-B-Healthy

Honey-B-Healthy® was developed in 1995 by a commercial beekeeper. Rich in specially processed essential oils, many large commercial beekeepers use it to fortify colony health and build resistance to the problems prevalent in today's apiaries. Easy to administer by either feeding or the dousing method. Honey-B-Healthy® can be added to a spray and used in place of smoke. Skilled beekeepers find it useful to build up weak colonies and when combining colonies.



**M01909** - 16 oz., Ship wt. 2 lbs. . . . . \$33.95  
*Makes up to 25 gallons of feeding mix*

**M01910** - 1 gallon, Ship wt. 12 lbs. . . . . \$144.15  
*Makes up to to 220 gallons of feeding mix*

**M01911** - 5 gallon, Ship wt. 57 lbs.\* . . . . . **CALL**  
*Makes up to 1,100 gallons of feeding mix*  
**Ships Freight Only \*See page 144**

**USED BY MANY OF  
 THE WORLD'S LARGEST  
 COMMERCIAL  
 BEEKEEPERS.**

## Vitamin-B-Healthy™

VITAMIN B HEALTHY™: used as a feeding supplement. Can be used alone in syrups, protein patties and along with Honey-B-Healthy® and Amino-B-Booster® to help strengthen colonies weakened from disease, pesticides and pollen stress. Helps provide needed nutrients vital for bee health and helps build strong healthy colonies for maximum honey production and pollination. Can also be used to help build up weak, over-winterized colonies, packages, nucs and swarms. Especially beneficial when bees are producing brood and available pollen sources are limited in quantity and/or the pollen is lacking essential vital nutrients causing dying yellowing (snot) brood and dwindling colonies.



**16 oz. Vitamin-B-Healthy**  
 Ship wt. 2 lbs.  
**M01939** . . . . . \$33.95

## Honey-B-Healthy® Super Plus

HONEY-B-HEALTHY® Super Plus: is a special essential oil emulsion and when used with Honey-B-Healthy®, Amino-B Healthy® and/or Vitamin-B Healthy™, produces a synergistic (amplified) effect. When used alone, Super Plus has been shown to help keep hives cleaner while improving overall colony health. We have observed that, when combined with any combination of other Honey-B-Healthy® products, Super Plus will accelerate consumption of the feeding mix. While any of our products can be used by themselves, we do advise that Amino-B Booster® be combined with Original Honey-B-Healthy or Honey-B-Healthy® Super Plus to help keep this liquid protein stable. (Amino-B Booster® provides the protein amino acids the bees need). Vitamin B Healthy™ provides the bees with needed vitamins and minerals. All of our products are made of food grade ingredients in an FDA registered food manufacturing facility. However, they are not intended for human consumption.



**16 oz. Honey-B-Healthy Super Plus**  
 Ship wt. 2 lbs.  
**M01937** . . . . . \$36.00  
**1 Gallon Honey-B-Healthy Super Plus**  
 Ship wt. 12 lbs.  
**M01938** . . . . . \$154.45

## Amino-B Booster

### Protein Benefits:

- Stimulates brood rearing when there is no natural pollen or nectar
- Simulates a nectar flow and pollen bloom when using 1:1 sugar syrup with HBH plus protein
- Provides all vital amino acids, plus 9 more
- Adds many health benefits especially with the HBH; larger, more robust and hardy bees
- Reinforces worn out stored pollen for late winter brood rearing
- When fed in sugar water with HBH, stimulates rapid build-up of nucs, swarms, package bees and weak colonies
- Can be used to help produce high quality queens by providing protein for royal jelly
- Can be used as a "Protein drench" when bees take pollen substitutes very slowly; just spray or drizzle the HBH-Protein into the cluster area; bees will clean it up, store it and use it

**Directions:** Use 1 tbsp. (15 ml) to 3 tbsp. (45 ml) in a quart or liter of sugar water along with 1 tsp. (5 ml) Honey-B-Healthy® Feeding Stimulant with essential oils as a preservative. Best fed in inverted jars on top of the colony.

**16 oz. Amino-B Booster**  
 Ship wt. 2 lbs.  
**M01914** . . . . . \$31.80  
**1 Gallon Amino-B Booster**  
 Ship wt. 12 lbs.  
**M01915** . . . . . \$149.95



# BROOD BUILDER

## AVAILABLE IN PATTY OR DRY FORMULA

### DRY FORMULATED FOR OUTDOOR DRY FEEDING



25 lb. bag - Dry  
M0014625

5 lb. bag - Dry  
M001465

If you live in some parts of California, the southwest or southern tier of the U.S., Brood Builder may be your answer to late winter or early spring outdoor dry feeding stimulation. If your bees can fly early in the year and collect Brood Builder, you can increase colony production.

Brood Builder must be protected from direct moisture such as rain, dew, fog and other inclement weather. Can be fed on platforms or trays directly in the bee yard. Honey bees collect Brood Builder because it is so close to pollen in nutritional value. Honey bees collect Brood Builder naturally, just as they would "real pollen."

**Directions for Use:** Feed as is from the package on platforms or trays directly in the bee yard. Must be protected from direct moisture, such as rain, dew, fog and other inclement weather. Fill feeders often.

### DRY

M001465 5 lb. Dry Quantity,  
Ship wt. 8 lbs. . . . \$14.70

M0014625 25 lb. Dry Quantity,  
Ship wt. 29 lbs. ea.

- 1-5 25# Bags . . . . . \$45.25
- 6-10 25# Bags . . . . . \$43.20
- 11+ 25# Bags . . . . . \$38.05

### WET MOIST PATTY FORMULA

Brood builder is a great feed to give your hive the boost it needs to increase the brood population. Mix with sugar syrup or fructose until you reach a cookie dough consistency then sandwich between two sheets of wax paper. Feed in-between brood boxes if running doubles and on top of top bars if running singles. Additional sugar can be added for faster consumption. If small hive beetles are a problem feed 1/4 to 1/2 lb patties and reapply as needed. Store extra patties in your deep freeze.

### PATTIES

#### Brood Builder Patties with Honey B Healthy

M0014610H 10 pack . . . . . \$27.75

M0014640H 40 lb. carton

- 1-20 Boxes . . . . . \$73.10 per box
- 21-39 Boxes . . . . . \$64.05 per box
- 40-159 Boxes . . . . . \$62.05 per box
- 160+ Boxes . . . . . CALL

#### Brood Builder Patties with Honey B Healthy & Nozevit

M0014640HHN 40 lb. carton

- 1-20 Boxes . . . . . \$99.85 per box
- 21-39 Boxes . . . . . \$89.20 per box
- 40-159 Boxes . . . . . \$86.80 per box
- 160+ Boxes . . . . . CALL

Minimum quantity of 40 pounds.  
May not be available at all branch locations.

**PERFORATED  
FOR QUICK BEE  
ACCESS**



**READILY BEE  
ACCEPTED**



# AP23 WINTER PATTIES / WINTER ITEMS



# AP23®

Artificial Pollen 23

## WINTER PATTIES

Dadant was the first to bring you the winter patty and continues to manufacture the best feeds available for winter and spring build up. Our winter patties are available in 10 lb and 40 lb. boxes. When Gabe first started playing around with the idea for a winter feed he knew the bees still needed a small amount of protein. At 4% protein and 96% carbohydrates this became the perfect complete winter honey bee feed and after two successful years overwintering hives running light on food stores, Dadant thought he had to share this with the rest of the beekeeping community. From the very start they have been a very popular item and we have been told time and time again that without them many hives would have succumbed to the harshness of winter.

**Get your freshly made winter patties today to have strong healthy hives come spring!**

### AP23 Winter Patties

|                    |             |                |
|--------------------|-------------|----------------|
| <b>M0016010PHW</b> |             |                |
| Ctn/ 10 patties    | .....       | <b>\$25.70</b> |
| <b>M0016040PHW</b> |             |                |
| Ctn/ 40            | 1-9 .....   | <b>\$66.90</b> |
|                    | 10-35 ..... | <b>\$60.70</b> |
|                    | 36+ .....   | <b>CALL</b>    |



### Moisture Box

The 8 and 10-frame moisture box was brought back by two new beekeepers trying to keep their hives alive during the winter. Place wood chips on hardware cloth to wick away condensation. Front door can be removed to feed winter patties without disturbing the colony. Four ventilation ports on the box help regulate air flow.

- M60060** Moisture Box 10-Frame Ship wt. 7 lbs..... **\$50.95**
- M600608** Moisture Box 8-Frame Ship wt. 7 lbs..... **\$51.45**



### Winter Wraps

Wrapping your hives for winter is one extra precaution we recommend. Our winter wraps are available in both 8 and 10 frame sizes and cover two deep boxes. With an R value of 4 these wraps are sure to keep your bees warm all winter long. Velcro strip for easy on/off.

- M610010** Winter Wrap 10-Frame Ship wt. 4 lbs. .... **\$36.00**
- M61008** Winter Wrap 8-Frame Ship wt. 4 lbs. .... **\$36.00**



### 10-Frame Bee Cozy Insulated Winter Wrap

Brought to you from our Canadian friends at NOD apiaries this two story bee cozy is sure to keep your bees warm all winter long. Slips over two double deep 10 frame boxes. R8 value.

- M61005** Bee Cozy Winter Wrap 10-Frame Ship wt. 3 lbs..... **\$36.00**



# AP23<sup>®</sup>

PATTIES WITH  
HONEY-B-HEALTHY



## BEST BEE NUTRITION ON THE MARKET

At Dadant & Sons we strive to bring you the best pollen substitutes available. After 4 years of working with two of the best nutritionists in the world, we are excited to bring you AP23<sup>®</sup>. AP23<sup>®</sup> stands for artificial pollen and is the 23rd formulation to be developed and tested to date. It is formulated to deliver all of the currently known nutritional needs of the honey bee, with optimal balance of nutrient levels, in a highly palatable blend of specifically selected ingredients. If you have tried the other pollen substitutes on the market you owe it to yourself to try the best. Available in both dry and patty form.

AP23<sup>®</sup> is a high protein feed developed for all levels of beekeepers. It helps maintain colony strength by boosting populations, which result in better crop pollination and honey crops.



AVAILABLE IN BOTH  
DRY AND PATTY FORM

CHECK YOUR LOCAL  
BRANCH FOR PRICING

### AP23 VS Competition:

1. Consumption rates are 2-3 times greater than all other pollen subs in our trials.
2. Optimal particle size for better digestibility. Digestibility estimated at 98+%.
3. All ingredients are from single manufacturing sources with known production parameters for improved consumption and digestibility.
4. Specific proteins used are isolated for purity – this means reduced indigestible sugars and other naturally occurring compounds that the bees cannot utilize.
5. Developed using computerized formulation program and based on specific nutrient needs of honey bees.
6. Formulated with bees preferred nutritional ingredients – based on 4 years of research with a wide variety of test diets.
7. Feed is consumed and stored by the bees. No signs of wasted feed on bottom boards or being drug out of hives as seen in other commercially available pollen subs in our trials.
8. Increase in certain amino acids help increase consumption.
9. Natural antioxidants and natural flavors.
10. Certain ingredients are added that may help optimum gut / bee health.
11. Repeat purchases by commercial beekeepers who report improved brood production and health.

| Guaranteed Analysis                 |      |
|-------------------------------------|------|
| Crude Protein, min.                 | 47%  |
| Crude Fat, min.                     | 3.5% |
| Crude Fiber, max.                   | 3%   |
| Moisture, max.                      | 12%  |
| Guaranteed analysis is for dry AP23 |      |

### AP23 Patties

|                         |         |
|-------------------------|---------|
| M001602PH - 2 pack      | \$11.30 |
| M0016010PH - 10 pack    |         |
| 1-3                     | \$38.05 |
| 4-10                    | \$37.05 |
| 11+                     | \$34.95 |
| M0016040PH 40#/ Patties |         |
| 1-20                    | \$89.55 |
| 21-39                   | \$77.20 |
| 40-159                  | \$73.15 |
| 160+                    | CALL    |

### AP23 Dry

|                      |         |
|----------------------|---------|
| M0016005 Dry 5# bag  |         |
| 1-10                 | \$23.75 |
| 11-up                | \$23.25 |
| M0016040 Dry 40# bag |         |
| 1-3                  | \$88.55 |
| 4-10                 | \$87.50 |
| 11-39                | \$81.30 |
| 40-159               | \$77.20 |
| 160+                 | \$74.10 |

**M001601500\***  
1 tote.. \$2,240.25  
Totes may not be available at all branch locations.  
*\*See page 144*

### AP23 with Complete (please see note below)

**M0016040PC\***  
72-120 cases ea.. \$102.25  
121+ ea. .... CALL

**AP23 WITH COMPLETE IS A SPECIAL RUN ITEM.** Minimum quantity of 3200# or 72–40 lb. cases must be purchased for us to run them. This item is not stocked at any Dadant Branch location and will be ran upon receipt of the order. We recommend placing orders in advance of the Spring and Winter rush when able. Available FOB Hamilton, IL. Ships by LTL. *\*See page 144*

# DISEASES, PARASITIC BEE MITES AND PREVENTIVE MANAGEMENT

The number of Parasitic Bee Mites and diseases affecting honey bees is not large. Of these, only a few are commonly serious enough to cause severe colony and financial losses to beekeepers.

However, in any consideration of bee disease, adopt a preventive attitude toward the treatment and management of bees. Accept the fact that disease can be costly in causing some degree in loss of honey crop, in diminished service as pollinating agents, in the cost of medications and labor expended for treatment and loss incurred in replacement of equipment and bees.

The Parasitic Bee Mites that have the most economic impact on beekeepers

are the Honey Bee Tracheal Mite (*Acarapis woodi*) which lives within the breathing tubes of the honey bee and the large Varroa (*Varroa destructor*) which is an external parasite which feeds on the hemolymph or blood of older larvae and pupae and adult honey bees.

Most diseases affect the honey bee in the larval stage of its development. American and European foulbrood are the two most common. AFB is the most virulent and destructive of the

two. Chalkbrood and sacbrood less frequently cause extensive losses.

Occurring nationwide, nosema is the major adult bee disease and is probably responsible for a greater loss of honey crops than any other disease. Its intensity fluctuates from place to place, year to year, and from season to season within a year. The peak level of infection shortens lives of the workers and reduces their ability to feed larvae during brood rearing.

Bee diseases have no physiological effect on people handling bees and equipment; eating honey, pollen, or comb from an infected colony; or using beeswax or beeswax products.

## SUGGESTIONS FOR PREVENTIVE MANAGEMENT

Apiary locations, large or small, should be carefully selected. If possible, avoid a low, damp spot where puddles of water will stand. Diseases can be spread by bees getting water from such pools, which may contain feces from infected bees or pieces of dead larvae and bits of comb from sick colonies. A source of running water nearby is preferred. Low spots may also be comparatively stagnant as far as air movement is concerned. The humidity of the area builds up during the cool periods of spring and fall. Too much humidity also contributes to poor wintering.

Light shade (or no shade) is generally preferable to a heavy dense shaded location which remains damp long after a sunny spot has dried out. The bees will not fly as early in the morning, as late in the evening, nor as well on cool days if they are setting in a dense shade.

Hives should be arranged within the apiary to keep drifting of bees from one colony to another at a minimum. Keep hives as far apart as practical. Placing them in a random manner is preferable, even though they may not look as neat as when in a straight line, where each one is exactly so far from the next.

Placing hives beside small bushes or such will help bees mark the location of

their hive. Natural markers will also make it easier for any supersedure virgins to locate their respective hives when returning from mating flights, lessening the number of queenless colonies.

A hive stand raises the hive off the ground and serves two main purposes. First, the bottom of the hive is less likely to rot or be eaten by termites. Even painted bottoms will need replacing more frequently when allowed to rest directly on the ground. Secondly, from the disease viewpoint, a wet bottom board is likely to be an "incubator" for the development of causative organisms. Keeping the bottom clear of wax scales and other debris, also helps reduce the buildup of disease.

A  $\frac{3}{4}$ " or 1" auger hole bored near the hand hold on the front of the hive will make a top entrance for the bees which will facilitate air circulation within the hive, reducing the buildup of humidity throughout the brood area.

Since honey is a bee disease-carrying medium for spores, etc., it should not be fed to any colonies unless you are absolutely certain the hive from which it came was free of disease. Honey purchased on the open market should never be fed to bees. There is no way of knowing what diseases you are buying in it.

Prolific queens, with a high percentage of egg hatchability so that every comb is filled solid with brood, are essential to maintaining strong colonies. Such colonies are less likely to become weak, rundown, and in turn, susceptible to diseases.

Transferring combs between colonies should be kept to a minimum. The same is true of shaking bees from one colony for boosting the weak or starting new ones. Be careful not to let honey from broken burr-combs drip on the ground when moving supers, etc. Not only is it possible to spread disease in this way, but it is a good way to get robbing started at times.

When you know the colonies are free of disease, moving combs of bees and brood is a good method of reducing the population of a crowded hive and building up a weaker one. Doing this with combs from newly purchased colonies is risky.

Wintering only healthy, strong colonies increases the probability of survival in good shape. Should a disease-weakened colony die before spring, whatever honey is remaining often will be robbed by other colonies—usually the strongest ones. They, in turn, will probably become infected.



VARROA DESTRUCTOR

# MEDICATION GENERAL USAGE

The following is offered as a guideline for medication usage. Be sure to follow label directions in your treatment program.

For the beginning beekeeper, choosing the right medications and knowing when to use them can be tricky. Following is a chart we have devised to simplify and explain these treatments. If you ever have any questions in regards to what type of

medication to use, call your nearest Dadant branch and they will point you in the right direction. We also suggest ordering your medications early so you will be prepared when it comes time to apply.

| MEDICATIONS/USAGE   | LENGTH OF TREATMENT   | METHOD OF APPLICATION   | TIME OF YEAR TO APPLY   |
|---|---|---|---|
| <b>Apivar</b><br>Varroa<br><i>see pg. 71</i>  | 42 days   | 1 strip for every 4-5 frames. Works by contact only. Place in high bee activity areas.  | Normally used as fall treatment. Cannot be used with honey supers on.   |
| <b>Apiguard</b><br>Varroa<br><i>(Also benefits in the control of Tracheal mites) see pg. 72</i> | Two treatments:<br>1st: 12-14 days<br>2nd: 2-4 weeks  | Place delivery tray on top of top bar frames. A ¼" space is needed. Close off screened bottoms and vent holes.  | Should be applied during the fall, unless infestation is severe. Temperatures 60°F-105°F. Don't apply when honey supers are on.   |
| <b>Apistan</b><br>Varroa<br><i>see pg. 73</i>   | 42-56 days  | 1 strip per 5 frames of bees.   | When temperatures are above 50°F, generally Spring and Fall.  |
| <b>Formic Pro</b><br>Varroa<br><i>see pg. 73</i>  | 14 days   | Apply two strips near the edges of the brood box.   | 14 days. Daytime temperatures must be 50-85°F.  |
| <b>Mite Away Quick Strips</b><br>Varroa<br><i>see pg. 73</i>                                    | 7 days  | Apply two strips near the edges of the brood box.   | 7 days. Daytime temperatures must be 50-85°F.   |
| <b>Tetra-B Mix/ Oxytetracycline</b><br>Foulbrood<br><i>see pg. 78</i>                           | Three treatments<br>4-5 day intervals   | Sprinkle recommended dosage around edges of brood box on top bars of frames. Once a week for 3 weeks.   | Treat Spring and Fall.  |
| <b>Oxalic Acid</b><br>Varroa<br><i>see pg. 74</i>   | 1 Treatment -<br>1 minute per hive  | Use drenching or vaporizer methods.   | Most effective early Spring or late Fall when there is little to no brood in the hive   |
| <b>Paramoth</b><br>Wax Moth<br><i>see pg. 79</i>  | 3-4 weeks   | 6 Tbsp. for 15 supers, duct tape all openings making as air tight as possible. Reapply crystals as needed. Air out supers prior to placing on hive 1-2 weeks. | Apply as needed, particularly in warm weather.  |
| <b>B402 Certan</b><br>Wax Moth<br><i>see pg. 79</i>   | Mix one part of B402 to 19 parts water (5% solution). Apply after frames have been extracted. Apply to both sides of frame (1 oz. fluid for deep frames) (2/3 oz. fluid for medium) (1/2 oz. fluid for shallow) Allow to dry before putting into storage. |   | Apply once after extraction. Needs to be used before any wax moth infestation and will give protection through and until the next season. It will kill young wax moth larvae. |



M01940

## Hive Inspection Sheet Notepad

Hive Inspection Sheets help to record hive activity, requeening, treatments, feeding, honey storage, honey extraction, and the condition of the hive. The notepad is made up of 25 sheets with pre-drilled holes to fit into a 3-ring binder. Ship wt. 1 lb. ea.

M01940 Hive Inspection Sheet Notepad . . . . . \$3.35

# VETERINARY FEED DIRECTIVE (VFD) LAWS

On Jan. 1st 2017 the Veterinary Feed Directive went into effect. All customers must have a VFD from their veterinarian to be able to purchase Tetra Bee Mix for the treatment or prevention of American and European Foulbrood. A copy of the VFD must be filled out and signed by your veterinarian for the number of colonies you are wishing to treat. You will then send a copy of the VFD to your local Dadant Branch. Once Dadant is in receipt of the VFD, they can send the antibiotic to you. The VFD form can be sent via fax, mail, or email to your local Dadant office.

To make things go as smoothly as possible we suggest building a relationship with your local veterinarian. If they themselves are not beekeepers, you should invite them to your apiary and show them the ins and outs of the beehive. You will want to teach them that beekeepers can use Oxytetracycline in two ways. One of them is being proactive. This beekeeper uses oxytetracycline before a sign of disease is present. It is also used reactively or by treating when disease is found within the hive. You will want to teach them about the times of the year that it is applied and how many applications it takes when treating. Most who treat proactively will treat in the spring and the fall. Others will treat only when the disease is present. Treatment time frames are 3 – 200MG doses at 4-5 day intervals. A VFD can be written for a period of up to 6 months by your local veterinarian.

If you have any questions regarding VFD laws that we didn't answer above, contact your local Dadant office and our sales staff will do the best they can to answer your questions or put you in contact with those who can. There is a chance that this will be appealed and done away with for small animals which would include honey bees. Should that happen, we will make an announcement via email and on our website at [www.dadant.com](http://www.dadant.com).

## Veterinary Feed Directive

All parties must retain a copy of this VFD for 2 years after the date of issuance.

Veterinarian: Dr John Doe Client: Dadant Apiaries  
Address: \_\_\_\_\_ Address: \_\_\_\_\_  
\_\_\_\_\_  
(business or home)  
Phone: \_\_\_\_\_ Phone: \_\_\_\_\_  
Fax or email (optional): \_\_\_\_\_ Fax or email (optional): \_\_\_\_\_

Drug(s) Name: Oxytetracycline Drug(s) Level: 200mg/colony g/ton Duration of use: 3 times 4-5 day intervals  
Species and Production Class: Honey Bees No reorders (refills) authorized: N/A  
Indication for use (as approved): Foulbrood  
Caution (related to this medicated feed, if any): Not to be used during main honey flow

### USE OF FEED CONTAINING THIS VETERINARY FEED DIRECTIVE (VFD) DRUG IN A MANNER OTHER THAN AS DIRECTED ON THE LABELING (EXTRA LABEL USE) IS NOT PERMITTED.

Approximate Number of **Bees/Hives**: \_\_\_\_\_  
Premises: (Address of where bees are located) \_\_\_\_\_  
Other Identification (e.g., age, weight) (optional): \_\_\_\_\_  
Special Instructions (if any): \_\_\_\_\_

Affirmation of intent (for combination VFD Drugs) (check box):

- This VFD only authorizes the use of the VFD drug(s) cited in this order and is not intended to authorize the use of such drug(s) in combination with any other animal drugs.
- This VFD authorizes the use of the VFD drug(s) cited in this order in the following FDA-approved, conditionally approved or indexed combinations(s) in medicated feed that contains the VFD drug(s) as a component.

| Drug(s)         | Drug Level(s) and any Special Instructions                 |
|-----------------|--|
| Oxytetracycline | 200 mg per colony 3-4 treatments each at 4-5 day intervals |
|                 |  |

- This VFD only authorizes the use of the VFD drug(s) cited in this order any FDA-approved, conditionally approved or indexed combinations(s) in medicated feed that contains the VFD drug(s) as a component.

Withdrawal Time (if any): This VFD Feed must be withdrawn <sup>48</sup> days prior to **honey flow**.

VFD Date of Issuance: \_\_\_\_\_ (Month/Day/Year)

VFD Expiration Date: \_\_\_\_\_ (Month/Day/Year)

Veterinarian's Signature: \_\_\_\_\_ (As specified in the approval; cannot exceed 6 months after issuance.)

# FOULBROOD

## DISEASE PREVENTION FOR HEALTHY BEES

### Tetra-B Mix\*

**Tetra-B Mix** is a ready-to-feed mixture containing the antibiotic oxytetracycline. Recommended as an aid in the control of American and European foulbrood. May be used for fall treatment of colonies prior to winter or for the spring treatment of overwintered colonies. Spread over the top bars of the frames in each section of the brood nest. All use should stop at least 6 weeks prior to a surplus honeyflow.

— Active Ingredient - Oxytetracycline —

- M00161** 10 lb. bags, 160 treatments, Ship wt. 11 lbs. ea.  
1-4 bags ..... \$30.85
- 5-49 bags ..... \$28.80
- 50+ bags ..... CALL

⊗ **M00163** 50 lb. bag, Ship wt. 52 lbs. ea. .... \$119.45

\*cannot be shipped outside of the U.S.

- **READY TO USE**
- **NO MIXING**
- **CONVENIENT**
- **EFFECTIVE**



**VFD  
REQUIRED**

Bulk 10 lb. or 50 lb. bags.

### Terramycin™\* — Concentrate —

**Terramycin** antibiotic is a proven treatment for American and European foulbrood. Blend with powdered sugar to make your own medication. Early spring treatment is recommended with three one tablespoon applications at 5 day intervals. Spread over top bars of frames in brood nest area. Treatment must be stopped 6 weeks prior to main nectar flow. TM-100MR.

#### Terramycin 100MR

A bulk pack used by commercial beekeepers for treating large numbers of colonies. A 50 lb. bag when properly mixed with sugar feeds 4000+ colonies. 50 lb. bag

⊗ **M00176** Terramycin, Ship wt. 53 lbs. ea. .... \$566.45

\*cannot be shipped outside of the U.S.

**VFD  
REQUIRED**



**M00176**

Early Detection of  
AFB or EFB  
Diagnostic kit  
**FINALLY!!!**  
NO MORE GUESSING!



Closeup of  
American Foulbrood Disease

### Foulbrood Diagnostic Kits

**AFB (American Foulbrood) Diagnostic Kit.**  
**M00133** 1 Kit, Ship wt. 1 lb.

- Qty. 1-4 ..... \$17.45
- Qty. 5-19 ..... \$16.35
- Qty. 20-49 ..... \$15.15
- Qty 50+ ..... CALL

**EFB (European Foulbrood) Diagnostic Kit.**  
**M00134** 1 Kit, Ship wt. 1 lb.

- Qty. 1-4 ..... \$17.45
- Qty. 5-19 ..... \$16.35
- Qty. 20-49 ..... \$15.15
- Qty 50+ ..... CALL



**M00133**

**98% +  
Accuracy**

**M00134**

# IPM MANAGEMENT



## Cypress Bottom Board with West Trap, Landing Board and IPM Board

This ultimate bottom board does it all. Made of Cypress this all-in-one bottom board will trap and kill SHB, allow you to check for mites with the IPM board, and give your bees a landing board to land on when coming back from foraging. Comes complete with West beetle trap and IPM board. Fully Assembled.

**M60040** 10-Frame Cypress Bottom Board, Ship wt. 6.5 lbs. . . . . \$41.15

## Assembled Varroa Screened Bottom Board

Provides a secure base, aids in the control of varroa mites and provides optimal ventilation for your colony.

### Ponderosa Pine Bottom Board & Varroa Screen all in ONE!

- B92101** Varroa Screened Bottom Board, Ship wt. 4 lbs. ea. . . . . \$25.65
- B92101-01** Replacement Board . . . . . \$6.95
- 5+ . . . . . \$6.65

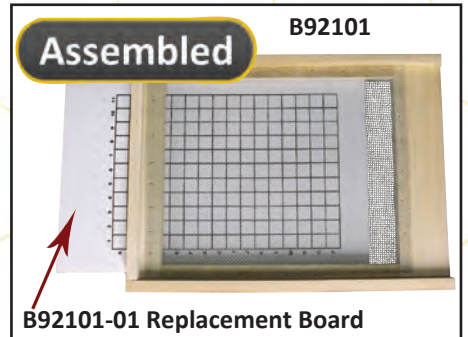

## Bee Gym

The Bee Gym is a patented device to assist and improve grooming behavior in honey bees to help them to control varroa mite populations.

**M01784** . . . . . \$20.55

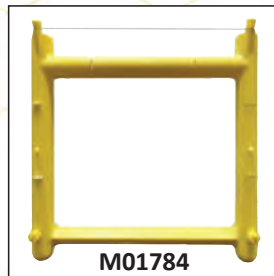

## Varroa EasyCheck

The Varroa EasyCheck is an essential tool for reliable Varroa monitoring. All beekeeping outfits big and small should have one on hand for quick diagnosis of Varroa infestation levels. Ship wt. 5.35 ozs

**M014908** . . . . . \$20.66

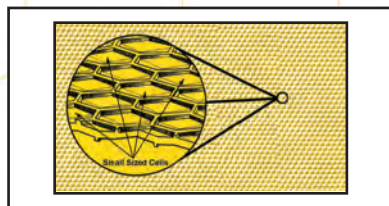

## Dadant Small Cell Beeswax Foundation 4.9 & 5.1

It is a fact that varroa mites have a difficult time reproducing on worker brood raised in small cell comb. So, if you are an experienced beekeeper who has an experimental nature, this may be an opportunity for you to move ahead of the chemical control crowd with your honey bee management.

**FOR PRICING SEE PAGE 18**

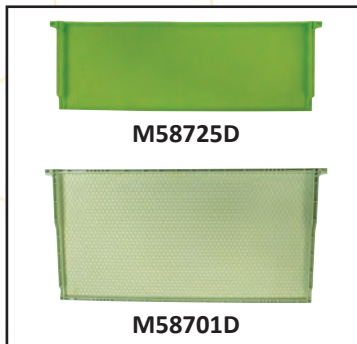

## Drone Comb 6 1/4" and 9"

- Ship wt. 1 lb. ea.
- M58725D** 6 1/4 coated drone comb 1-10 . . . . . \$3.85
- M58701D** 9 coated drone comb 1-10 . . . . . \$4.25

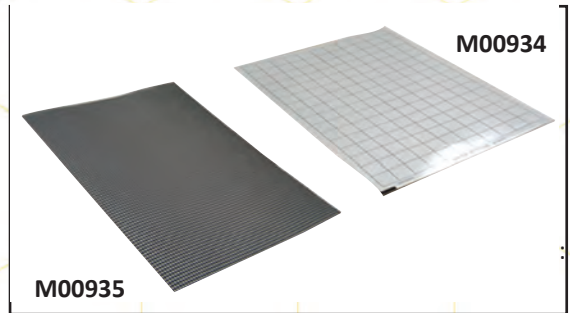

## Varroa Screen

- Peel cover paper from adhesive board
  - Place mesh screen over adhesive board
  - Slide unit through existing entrance on bottom board
- M00935** Varroa Screen Ship wt. 4 ozs. ea. . . . . \$4.05
  - M00934** Sticky Board Ship wt. 4 ozs. ea. . . . . \$4.05
  - M00936** Screen & Board — Complete, Ship wt. 8 ozs. ea. . . . . \$8.15

# IPM MANAGEMENT

## Cutts Beetle Blaster

Retired Florida State Apiary Inspector Laurence Cutts has come out with this disposable beetle blaster. Similar to the AJ's beetle eater at a portion of the cost. Fill with a small amount of vegetable oil and put in between top bar frames. We suggest two per box when infestations are severe. Discard after each use. Ship wt. 1 lb. ea.

|   |               |
|---|---------------|
| <b>M01945</b> Regular size Beetle Blaster |               |
| 1-49 .....                                | <b>\$2.15</b> |
| 50-99 .....                               | <b>\$2.00</b> |
| 100-999 .....                             | <b>\$1.90</b> |

|                                   |               |
|-----------------------------------|---------------|
| <b>M01952</b> Mini Beetle Blaster |               |
| 1-49 .....                        | <b>\$1.70</b> |
| 50-99 .....                       | <b>\$1.60</b> |
| 100-999 .....                     | <b>\$1.40</b> |

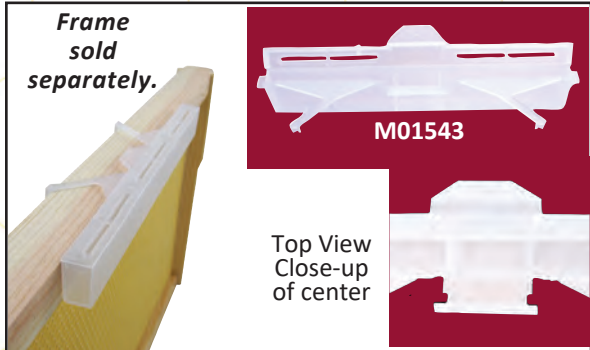

### Reusable Beetle Trap

This in-hive re-usable trap comes with 3 trays to hold your favorite beetle bait, vegetable oil, or diatomaceous earth. Has a hinged lid for easy access to clean for re-use.

|                                    |               |
|------------------------------------|---------------|
| <b>M01543</b> Reusable Beetle Trap |               |
| Ship wt. 7 ozs. ea. ....           | <b>\$3.60</b> |



### Beetle Bee-Gone

Beetle Bee Gone sheets are an all-natural, chemical free way to trap small hive beetles. Place one to two sheets per brood chamber where beetles congregate. Re-apply sheets the next time working these infested colonies and watch them disappear naturally. 48 sheets.

|  |                |
|--|----------------|
| <b>M01545</b> Beetle Bee-Gone, Ship wt. 1 lb. ea. .... | <b>\$10.15</b> |
|--|----------------|

## West Small Hive Beetle Trap

The 1<sup>st</sup> Small Hive Beetle Trap That Works!

The West SHB Trap was designed to sit on the bottom board just where SHB naturally like to hide. The trap consists of a tray that you partially fill with a small amount of vegetable oil and a specially designed lid that is covered with almost 300 small slots. The SHB, in looking for a place to hide from the honey bees trying to catch them, head for the slots as an escape route, which is a dead end that leads directly to the tray filled with thick non-toxic vegetable oil. The SHB falls into the vegetable oil, are coated with it, suffocate, and die. It's just that simple!

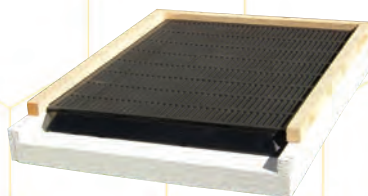

**Bottom Board Not Included**  
**Fits 10-Frame only**

### COMPONENT DIAGRAM

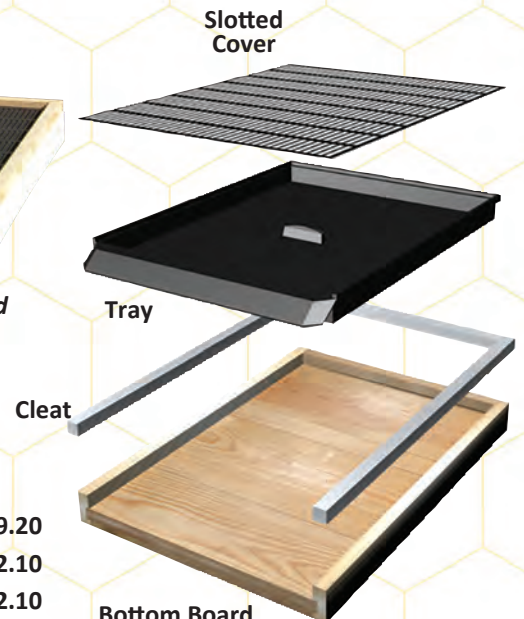

|   |                |
|---|----------------|
| <b>M01540</b> Beetle Trap Complete, Ship wt. 5 lbs. ea. ....                  | <b>\$19.20</b> |
| <b>M015401</b> Side Cleat for Beetle Trap, Each, Ship wt. 2 lbs. ea. ....     | <b>\$2.10</b>  |
| <b>M015402</b> End Cleat for Beetle Trap, Ship wt. 2 lbs. ea. ....            | <b>\$2.10</b>  |
| <b>M015403</b> Cleat Set for Beetle Trap, Ship wt. 2 lbs. ea. ....            | <b>\$4.20</b>  |
| <b>M015404</b> Beetle Trap Tray w/ Cover, No Cleats, Ship wt. 3 lbs. ea. .... | <b>\$16.45</b> |



# VARROA MITE MEDICATION

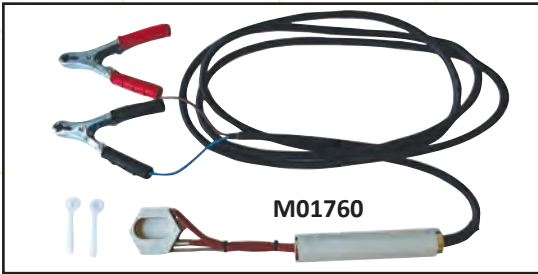

## Oxalika Vaporizer

From our friends in Italy come the The Oxalika Vaporizer. It runs on a 12 volt battery and comes complete with two dosing spoons. This sublimator is the only one of its kind with a device to control the temperature of the heating cup which will increase efficacy that is lost by many other vaporizers on the market that run at higher temperatures. Treatment time is 1 minute 30 seconds. No need for cooldown between treatments. Made in Italy.

**M01760 Oxalika Vaporizer . . . . . \$164.75**

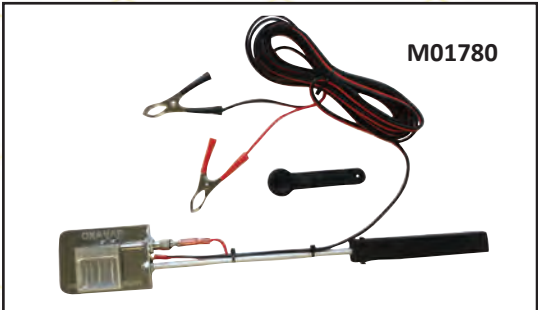

## VarroVap Vaporizer

We are pleased to offer the VarroVap vaporizer. The VarroVap cannot be dunked in water. Wash with a wet rag or sponge in-between each application. Runs on a 12 volt battery. Ship wt. 2 lbs. ea.

**M01780 VarroVap . . . . . \$144.15**



## Half Mask Respirator Kit

The 8000 Series Respirator conforms to the contours of your face. It seals comfortably and remains sealed, even while talking. Plus, the seal is extra-wide, so it fits more facial types. No inhalation valves to stock. No installation. Less maintenance, less parts. Cartridges snap-in, which eliminates mistreading. Plus, the weight is distributed evenly, without pressure points. The low profile provides a larger field of vision than any other respirator and makes it easier to wear safety eyewear. Be sure to review all fitting instructions and safety guidelines in the user manual prior to using this product. 2 cartridge filters included.

**M01769S** - Small  
**M01769M** - Medium  
**M01769L** - Large  
 Ship wt. 1 lb.  
**\$46.30**



Replacement filters  
 (2-pack)  
**M01771**

## Replacement Cartridge Filters for Half Mask Respirator

Organic Vapor/Acid Gases Replacement Cartridges for Half Mask Respirator. Easy to use Snap-In Replacement Cartridge Filters for Moldex 8000 Half Mask Respirator. Be sure to review fitting and safety guidelines prior to use. **2-pack.** Ship wt. 1 lb.

**M01771**  
**\$23.30**



## Oxalic Acid Safety Kit

Kit includes a pair plastic gloves, & plastic vent goggles for eye and hand safety. A syringe & metal scoop are also included to help in the application processes. It is also recommend to wear long clothing to avoid skin contact. Be sure to follow all safety guidelines and instructions on manufacturers label for oxalic acid. **Oxalic Acid sold separately.**

**M01774 Oxalic Acid Safety Kit,**  
 Ship wt. 1 lb. . . . . **\$16.40**

## Oxalic Acid\*

Oxalic acid is a newly registered chemical control for Varroa Mites. Can be used in both drench and vaporization methods. Best used during broodless periods late fall through early spring, in packages, and nucleous colonies. Can't be used on colonies during a honey flow with supers in place. Available in 3 sizes.

- M01758 Oxalic Acid - 35 grams, Ship wt. 3 ozs. . . . . \$8.20 each**
- M01763 Oxalic Acid - 175 grams, Ship wt. 8 ozs. . . . . \$22.65 each**
- M01764 Oxalic Acid - 350 grams, Ship wt. 1 lb.. . . . \$39.15 each**

**\*NOT AVAILABLE IN CA**



**M01758 M01763 M01764**

# VARROA MITE MEDICATION



**THERE MAY BE OTHER THYMOL PRODUCTS ON THE MARKET TODAY, BUT WE ARE PLEASED TO OFFER APIGUARD® FOR VARROA MITE CONTROL. WITH PROVEN EFFICACY, IT IS THE BEST THYMOL PRODUCT OFFERED IN THE U.S. TODAY.**

A Vita-Europe Ltd. product by Dadant & Sons, Inc.

**Foil pack contains 10 individual 50g treatments ready for application.**

**M01480 Apiguard® \***  
 c/10 Foil Pack, Ship wt. 2 lbs. ea.  
 1-9 ..... \$36.00  
 10 + ..... \$33.50

**\*cannot be shipped outside of the U.S.**



Foil tray shown on brood frames.

**Bulk tub comes complete with syringe and delivery pads.**

**M01481 Apiguard® Bulk Tub (6.6 lbs.)\***  
 Contains 60 50g treatments in bulk gel form.  
 Ship wt. 8 lbs. ea.  
 1-19 ..... \$102.95  
 20-99 ..... \$101.90  
 100-299 ..... \$96.80  
 300+ ..... \$93.20

**M01482 Apiguard® delivery pads only. c/250**  
 Ship wt. 3 lb. ea. .... \$16.45



M01481

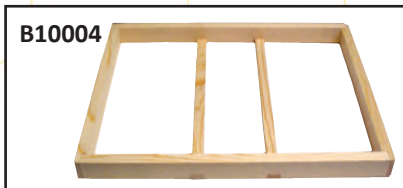

B10004

**Use Rim & Sticks to allow for correct spacing**

**NAILS NOT INCLUDED**

**B10004 Rim & sticks come unassembled.**  
 Ship wt. 3 lbs. ea. .... \$4.50

## VARROA: WAKE UP TO THE NATURAL EFFICACY OF APIGUARD®

*A slow release thymol gel, a new and effective treatment*

- A natural and non-toxic treatment
- Through thousands of treatments, efficacy rates ranged from 85% to 95%, with an overall average of 93%.
- It respects both the hive products and the consumer
- Encourages the hygienic behavior of the honey bee, preventing a number of related problems
- Resistance is controlled and unlikely to occur with Apiguard
- Ease of use: 2 x 50 gm treatment trays per hive, with an interval of 14 days, in summer just after the honey flow
- Best results occur when bees are active and maximum daily temperatures are between 60°F and 105°F.
- Though registered as a Varroa treatment, Apiguard has been proven to effectively treat Tracheal mites as well.

### To Use Apiguard

Place the dosing tray or pad centrally on the top of the brood frames gel side up. Be sure to allow at least ¼" of spacing between the top of the tray and the cover using spacer boards or empty supers as needed. Apply the second dose 14 days after the first. Screened bottom boards should be closed while Apiguard is being applied.

## Formic Pro\*

Formic Pro™ is the next generation in formic acid treatments for mites. Made of all natural materials, this product can be used during the honey flow. Unlike Mite Away Quick Strips, Formic Pro™ has a longer shelf life of 24 months and no temperature requirements for storage. Daytime temperatures still must be between 50°F - 84°F (10° C- 29° C) when used.

Strips are to be placed across the top bars between brood boxes or on top of a single deep hive. Be sure to wear the recommended safety equipment for acid.

Treatment Options:

- 14 day Treatment: 2 strips for 14 days.
- 20 day Treatment: 1st strip for 10 days remove and replace with 2nd strip for an additional 10 days.

**May not be available at all locations.**

**Please call for pallet pricing.**

**\*cannot be shipped outside of the U.S.**

|               |                             |                 |
|---------------|-----------------------------|-----------------|
| <b>M01464</b> | c/2, Ship wt. 2 lbs. ....   | <b>\$16.95</b>  |
| <b>M01465</b> | c/10, Ship wt. 7 lbs. ....  | <b>\$57.95</b>  |
| <b>M01467</b> | c/30, Ship wt. 20 lbs. .... | <b>\$144.95</b> |



## Mite Away Quick Strips\*

Mite Away Quick Strips are a Formic Acid polysaccharide gel strip which, when placed in the brood chamber of a honey bee hive, is an organic miticide that kills the Varroa mite where it reproduces under the brood cap. 2 strips per hive. Do not remove the white paper from the gel strips. Keep bottom entrances open the full width of the hive. Screened bottom boards can be left open if used along with top entrances. Treatment duration 7 days with daytime temperatures of 50-92°F.

**May not be available at all locations.**

**Please call for pallet pricing.**

**\*cannot be shipped outside of the U.S.**

|               |                             |                 |
|---------------|-----------------------------|-----------------|
| <b>M01460</b> | c/2, Ship wt. 2 lbs. ....   | <b>\$15.95</b>  |
| <b>M01461</b> | c/10, Ship wt. 7 lbs. ....  | <b>\$52.95</b>  |
| <b>M01463</b> | c/30, Ship wt. 18 lbs. .... | <b>\$132.95</b> |



## Apistan™ Strips\*

Apistan™ Strips are a product developed specifically to control Varroa mites in honey bee colonies. There is no more convenient chemical method for beekeepers to use to kill Varroa mites.

*For complete consistent control of Varroa mites use Apistan™ according to label directions.*

### Treatment For 5 Hives

|                |  |                |
|----------------|--|----------------|
| <b>M001261</b> | Apistan™ Strips, 10 per pkg.,<br>Ship wt. 1 lb per pkg. .... | <b>\$34.95</b> |
|                | 10+ packages-per pkg. ....                                   | <b>\$34.00</b> |

### Treatment For 50 Hives

|               |   |                 |
|---------------|---|-----------------|
| <b>M00126</b> | Apistan™ Strips, 100 per pkg.,<br>Ship wt. 2 lbs. per pkg. .... | <b>\$219.95</b> |
|               | 6+ packages-per pkg. ....                                       | <b>\$216.25</b> |



# VARROA MITE MEDICATION



## AMITRAZ CONTROLLED-RELEASE TECHNOLOGY

1. Amitraz is a sub-lethal miticide that paralyzes Varroa mites. Varroa cannot keep holding on to the bees and fall to the bottom of the hive, leading to their starvation.
2. Plastic polymer strip: specially designed to ensure a regular release of amitraz on the surface of the strip after its placement in the hive. The polymer strip was chosen for its rigidity and its ability to continuously release the active ingredient over a minimum six-week period.

## HOW IT WORKS IN THE COLONY

Apivar works by contact: the active ingredient is delivered continuously over time. As bees walk on the strip's surface they pick up molecules of the active ingredient and then distribute them throughout the colony.

Notch support between the frame headers



|               |                  |         |
|---------------|------------------|---------|
| <b>M01490</b> | 10 strips/pkg    |         |
|               | 1-9 pkgs. ....   | \$37.05 |
|               | 10-49 pkgs. .... | \$34.75 |
|               | 50+ pkgs. ....   | CALL    |

|                 |             |          |
|-----------------|-------------|----------|
| <b>M0149050</b> | c/50        |          |
|                 | 1-9 .....   | \$140.95 |
|                 | 10-49 ..... | \$133.90 |
|                 | 50+ .....   | CALL     |

Call for larger quantities

\*cannot be shipped outside of the U.S.

*"Apivar's polymer strip was chosen for its rigidity and its ability to continuously release the active ingredient over a minimum six-week period."*

AVAILABLE AT ALL DADANT BRANCHES

## Wax Moth\*

**Para-moth**—A dry crystal that does an excellent job of keeping wax moths and their larvae under control. Place on top of a stack of stored supered combs. For 1 and 5 lb. quantities, branch pickup only is available. If shipped, product will ship from Hamilton, IL, ground only. **Additional charges may apply.**

**No shipping for 35 lb. quantity ships LTL only or branch pickup only.**

**\*cannot be shipped outside of the U.S.**

**Not available at all Dadant branches  
(Not available in CA, HI, and MA)**

- ❌ **M00140** 1 lb., Ship wt. 2 lbs. ea. . . . . \$23.80
- ❌ **M00141** 5 lbs., Ship wt. 6 lbs. ea. . . . . \$54.95
- ❌ **M00142** 35 lbs., Ship wt. 38 lbs. ea. . . . . \$209.95



## Wax Moth Damage

### Para-Moth Drawer

**AVAILABLE IN 10-FRAME AND 8-FRAME**

These drawers are a convenient way to apply Para-Moth crystals as needed. Stack supers as you would normally store them for the season putting the Para-Moth drawer on top. Pull out the drawer to easily apply more Para-Moth. Ship wt. 3 lbs. ea.

- B93501** 10-Frame Para-Moth Drawer . . . . . \$29.40
- B935018** 8-Frame Para-Moth Drawer . . . . . \$29.40

## B402 Certan

B402 Certan is the most advanced effective and economical product for the protection of your combs from damage by wax moths. It is a safe environmentally friendly product. It is a concentrated solution of *Bacillus thuringiensis*. It leaves no residues in wax or honey. Only one application needed for complete protection. Efficacy of up to 100% against wax moth larvae. It is used after the honey harvest, when the frames are stored. It must be used before a wax moth infestation. It will kill young wax moth larvae. A single application will provide protection against wax moth right up through to the following season. Applicators and mixers should wear long sleeve shirt, long pants, socks, shoe, protective eye wear and a NIOSH approved particle filtering respirator. Mix one part of B402 to 19 parts water (5% solution). Apply after frames have been extracted. Apply to both sides of frame, 1 ounce of fluid for deep frame, 2/3 ounce of fluid for medium frame and 1/2 ounce of fluid for shallow frame. Allow to dry before placing in storage. In warm conditions, once dry, supers should be protected from re-infestation by being wrapped or stored in an enclosed space.

- M02140** B402 Certan 5 oz., Shipping wt. 7 oz. . . . . \$32.95
- M02141** B402 Certan 1 quart, Shipping wt. 3 lbs. . . . . \$179.95

## Fumidil-B

**Fumidil-B** —The only known registered treatment for nosema. Feed in sugar syrup during the spring and fall to keep your spore counts low.

- No residue in honey when used as directed.
- Cost effective. Reduces expensive colony replacement and results in more productive colonies.

Add 1 - 500 gram bottle to 1 gallon of water to dissolve. Makes 110 gallons of treatment when added to 110 gallons of syrup.

- M0017025** Fumidil-B 25g . . . . . \$34.95
- M00170** Fumidil-B 500g . . . . . \$214.95



**Assembled TOP VIEW**



**M02140 M02141**

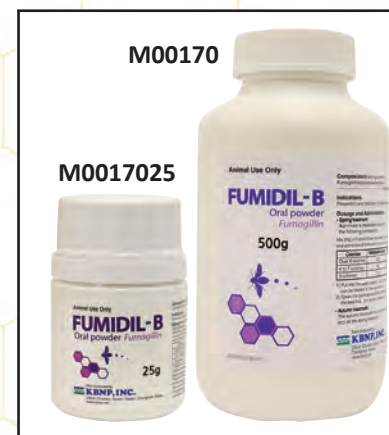

**M00170 M0017025**

# SWARM PHEROMONES AND CATCH BOX



M01998

## Swarm Commander Swarm Lure Crush Vials

A brand new product from Blythewood Bee Company. Swarm Commander Crush Vials are a new and easy way to bait your swarm traps. Simply remove the vial from the package. Crush the vial in the center until the internal glass vial breaks and the swarm commander fluid is released. Allow the fluid to absorb into the cotton plug. Swab the landing board of your hive as desired. After that, throw the lure into your box. Your hive will be baited for a minimum of 2 weeks (Tests Show 20 Days).

M01998 Ship wt. 0.7 ozs. . . . . \$13.95



M01982

## Swarm Commander - Spray

Swarm commander spray is the perfect attractant to use when trying to catch swarms of bees. Spray the inside of your bait box with swarm commander and watch the bees come in. 100 applications per bottle. Ship wt. 2 ozs.

M01982 . . . . . \$32.90



M01984

## Swarm Commander Super Lure

This Swarm Commander Super Lure is huge. Creator Scott Derrick did it again with this awesome 90 day swarm attractant. Just hang it in your bait box and wait for the swarms to come. Ship wt. 1 oz.

M01984 Swarm Commander Super Lure \$16.45

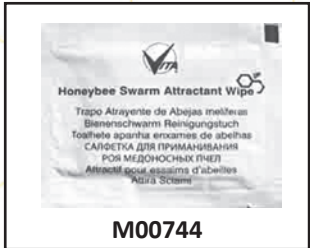

M00744

## Swarm Lure

Vita Europe has come out with another great product. These swarm lures can be hung on the inside of your swarm box. Once opened, it is effective for 2 weeks then needs to be replaced. Hang at 6-8' off the ground. 10/box. Ship wt. 2 ozs.

M00744 Swarm Lure c/10, . \$23.30



M00741

## Swarm Catch

**Swarm Catch** contains Nasonov: the orientation pheromone, sometimes called the "come hither" pheromone. On average, swarms will occupy 50-80% of catch boxes with Swarm Catch (provided there is a reasonable amount of swarming in the area). *Place Swarm Catch lure into an empty super with comb (comb should not contain honey). Store lures in the freezer until use.*

- Capture swarms from your own hives thus reducing loss of honey bees.
- Add to your hive count and honey yield by capturing stray swarms from other hives in the area.

M00741 2 Vial Pack,  
Ship wt. 8 ozs. ea. . . \$11.65

M00742 5 Vial Pack,  
Ship wt. 12 ozs. ea. . \$23.30

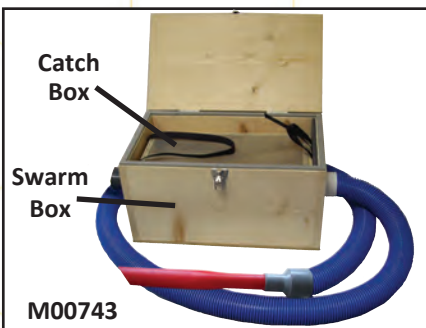

M00743

## Swarm Box

Texas beekeeper Dwain Cleveland brought his swarm box to our attention. After seeing it in action, we thought we'd bring it to yours. Outer box connects to most shop vacs. Additional adapters may be needed as hoses will vary. Inner capture box holds approx. 3 lbs. of bees. More catch boxes may be needed, depending upon the size of the swarm you're trying to catch. **DVD included.**

M00743 Swarm Box  
Ship wt. 32 lbs. . . . . \$226.55

## Catch Box

For the larger swarm, more catch boxes may be needed. These are made to fit our swarm box only.

M00743CB Catch Box  
Ship wt. 7 lbs. . . . . \$75.85



M00743CB

**Frames not included**



M01981

## Swarm Commander - Vials

Swarm commander vials are the perfect tool to use when trying to capture a swarm of bees. Hang inside your bait box or trap. Come in c/5. Ship wt. 8 ozs. ea

M01981. . . . . \$13.35



**Hive not included**

M60065

## Entrance Excluder

The entrance excluder will keep your queen and drone bees inside the hive. Useful tool when seeing hives preparing to swarm in the spring. Place entrance excluder on front of hive with nails to pin it in place. Use while installing new packages and during the winter as your mouse guard.

M60065 Ship wt. 1 lb. . . . . \$8.10

# NUC BOXES AND COMPONENT PARTS

## Pro Nuc Box

The Pro Nuc design is superior to any others we have seen. With locking lid, 2 feed ports, great ventilation and closable entrance this nuc box is needed in your bee mobile. Currently available in 9 5/8" depth size. Ship wt. 7 lbs. ea.

|                            |         |
|----------------------------|---------|
| <b>M01515</b> Pro Nuc Box, |         |
| 1-9 .....                  | \$18.50 |
| 10-99 .....                | \$17.45 |
| 100-299 .....              | \$15.40 |
| 300+ .....                 | \$13.35 |

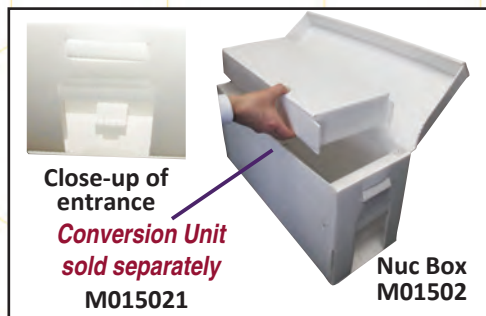

## Jester's EZ NUC

Jesters EZ Nuc is made of one piece corrugated plastic for durability and strength. Great all around Nuc box.

|                 |               |         |
|-----------------|---------------|---------|
| <b>M01502</b>   | 1-9 .....     | \$14.40 |
| Jester's EZ NUC | 10-99 .....   | \$12.10 |
| Ship wt. 2 lbs. | 100-299 ..... | \$10.40 |
|                 | 300+ .....    | \$9.65  |

## Jester's EZ NUC Conversion Unit

|   |        |
|---|--------|
| <b>M015021</b> Conversion Unit to 6 5/8", |        |
| Ship wt. 1 lb. ....                       | \$4.40 |

## Wooden Nuc Box

Multiple Uses! Swarm Trap, Nuc Box, Split, Divides, Queen Production, Queen Mating Box and more. This small 5-frame lightweight nuc box is an easily transportable Ponderosa Pine nuc box that fills all those special needs that a heavy full size hive can't!

*Frames sold separately.*

|                           |         |
|---------------------------|---------|
| <b>B53401</b> Nuc Box,    |         |
| Ship wt. 15 lbs. ea. .... | \$47.55 |



## Assembled Plywood Nuc 6 5/8" & 9 5/8"

Fully Assembled plywood nuc box is available in both 6 5/8" and 9 5/8" depth. These 5-frame boxes are perfect for making splits in the spring, summer and fall. Also works well as swarm boxes and for swarm removals. **PAINTING IS REQUIRED.**

|                               |         |
|-------------------------------|---------|
| <b>M60015</b> 6 5/8" Nuc Box, |         |
| Ship wt. 11 lbs. ea.          |         |
| 1-28 .....                    | \$25.65 |
| 29-58 .....                   | \$24.45 |
| 59+ .....                     | \$23.30 |

|                               |         |
|-------------------------------|---------|
| <b>M60020</b> 9 5/8" Nuc Box, |         |
| Ship wt. 11 lbs. ea.          |         |
| 1-28 .....                    | \$25.65 |
| 29-58 .....                   | \$24.45 |
| 59+ .....                     | \$23.30 |

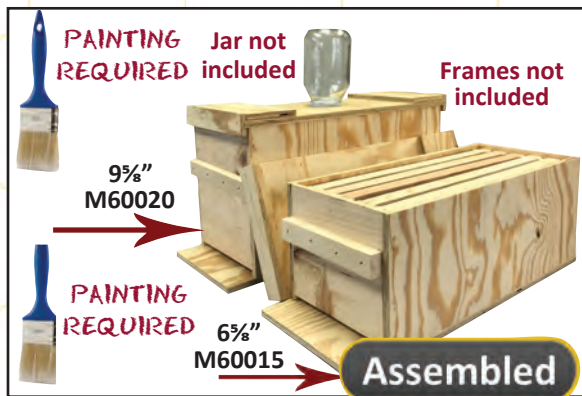

## Plywood Nuc Top Cover Only

This 5-frame nuc cover is fully assembled. G70 feeder cap fits the hole in the center and makes feeding your start up colonies a breeze. **PAINTING IS REQUIRED.**

|  |         |
|--|---------|
| <b>M60030</b> Plywood Top Cover only, Ship wt. 3 lbs. ea. .... | \$11.60 |
|--|---------|

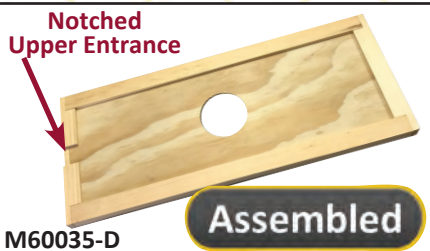

M60035-D

## Plywood 4- & 5-Frame Inner Cover w/ Feeder Hole

Our nuc inner cover is the same one that comes with our support hive. It works well with both 4 and 5-frame nuc boxes. Place empty nuc box on top of inner cover to act as a feed shell. Invert feed jar in hole. Standard G-70 Boardman Feeder lid fits hole. Feeder lid not included.

|   |                             |         |
|---|-----------------------------|---------|
| <b>M60035-D</b> Nuc Inner Cover w/ Feeder Hole, | Ship wt. 1.5 lbs. ea. ....  | \$11.65 |
| <b>M00887</b> Feeder Lid Only (not shown),      | Ship wt. 0.25 lbs. ea. .... | \$0.98  |

## Nuc Screened Bottom Board — Assembled

Aids in the control of varroa mites and provides optimal ventilation for your nucs. Ship wt. 3 lbs. ea. **B92901NA** Nuc Screened Bottom Board, . \$19.80

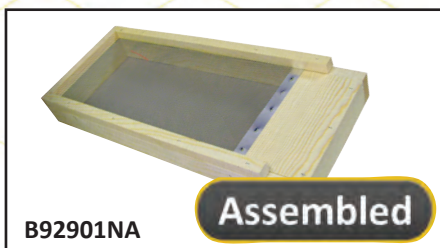

B92901NA

## 9 5/8 5-Frame Nuc Box



|                       |         |
|-----------------------|---------|
| <b>B53210</b> Nuc Box |         |
| Ship wt. 7 lbs. ea.   | \$14.95 |

# QUEEN REARING, SUPPORT HIVES AND QUEEN INTRODUCTION

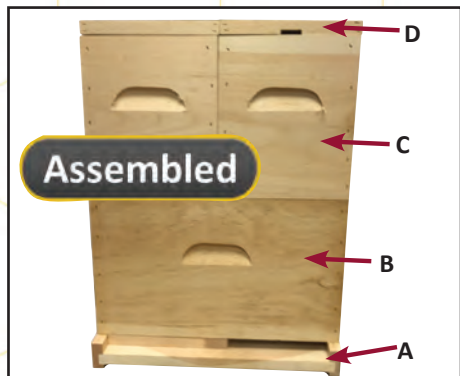

## Support Hive

Support hives are needed in every out yard you have. Two 4-frame hives make up the support colonies. Great for boosting a weak hive or for holding queens in case a replacement is needed. Entrances are on opposite ends to keep each colony from encroaching on the others territory. Comes with a special divided bottom board, single divided deep brood box, two 4-frame nucs and two inner covers w/feed hole. Fully assembled and ready for a coat of paint. **Top covers and frames sold separately.**

- M60035** Support Hive, Ship wt. 28 lbs. ea. .... \$127.65
- M60035-A** Bottom boards for Support Hive, Ship wt. 4.75 lbs. ea. .... \$26.65
- M60035-B** Deep box w/ divider, Ship wt. 10.5 lbs. ea. .... \$31.50
- M60035-C** 4-Frame Nuc boxes for Support Hive, Ship wt. 5 lbs. ea. .... \$24.45
- M60035-D** 4-Frame Inner covers for Support Hive, Ship wt. 1.5 lbs. ea. .... \$11.65



## Queen Rearing Hotel

Our queen hotel is exactly what you need to continuously raise your own queens. Split into 4 – 2-frame nucs or 2 – 5-frame nucs. When you find a frame with a queen cell, put it and another frame into our queen rearing hotel and come back in a few weeks to find your mated queen or queens ready for placement into a split or queenless colony. You must use a standard 10-frame telescoping lid with this unit which is sold separately.

- B55101** Queen Rearing Hotel, Ship wt. 20 lbs. ea. .... \$52.05



## Cloake Board

The Cloake board is a device invented by New Zealand beekeeper Harry Cloake to raise queens with a minimum amount of equipment. Consists of a wooden frame w/queen excluder and metal tray and involves a series of stages which divide a colony into a queen right lower colony and queenless upper colony which improves acceptance of grafted larvae. Requires knowledge in grafting larvae. Full set of instructions provided.

- B41301** 10-Frame Cloak Board, Ship wt. 6 lbs. ea. .... \$36.05
- B41301B** 8-Frame Cloak Board, Ship wt. 6 lbs. ea. .... \$36.00

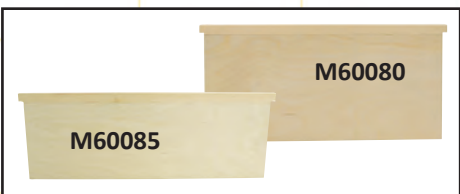

## 6<sup>5</sup>/<sub>8</sub>" and 9<sup>5</sup>/<sub>8</sub>" Follower Boards

Our 9<sup>5</sup>/<sub>8</sub>" and 6<sup>5</sup>/<sub>8</sub>" follower boards are just the ticket to help your small hive grow into its larger box. Use the follower board in place of a frame to condense a hive down and expand it as it grows. Great for small swarms and splits. Use your standard 10-frame hive and make it into two separate nuc boxes. Great for helping your apiary grow. Ship wt. 2 lbs. ea.

- M60080** 9<sup>5</sup>/<sub>8</sub>" Follower Board ..... \$5.60
- M60085** 6<sup>5</sup>/<sub>8</sub>" Follower Board ..... \$5.60



## Double Screen Board

The double screened board makes requeening easy and efficient. When dividing a colony, remove your top chamber and place your d/s on top of the bottom chamber and place your split on top of the d/s. The older foraging bees will return to the bottom chamber leaving the younger bees, which will accept the new queen with much less stress. You can also replace the d/s with a queen excluder and run a double queen colony.

- B91601** 10-Frame Double Screen Board, Ship wt. 3 lbs. ea. .... \$26.65
- 5+ ..... \$23.75
- B91601B** 8-Frame Double Screen Board, Ship wt. 3 lbs. ea. .... \$26.25
- 5+ ..... \$23.30



## Requeening Frame

Our re-queening frame will work with most wooden queen cages. This allows the queen to be readily accepted prior to being released. Be sure to remove the cork from the candy end and secure queen cage to frame.

- M01592** Requeening Frame, Ship wt. 2 lbs. ea. .... \$15.30



## Nuc Introduction Board

The nuc introduction board will help you unite your 5-frame nucs into a standard 8- or 10-frame colony. Place on top of your colony and cover with a sheet of newspaper. Spray the paper with sugar water and the bees will eat through the paper uniting the two colonies together. After a few days move the frames from the nuc into your standard box.

- B41401** 10-Frame Nuc Introduction Board, Ship wt. 2 lbs. ea. .... \$9.55
- B41401B** 8-Frame Nuc Introduction Board, Ship wt. 2 lbs. ea. .... \$9.55



# RAISE YOUR OWN QUEENS WITH THE EZI QUEEN SYSTEM

## EZI-QUEEN SYSTEMS

Queen rearing

The system assumes basic queen rearing knowledge, see below for book *Contemporary Queen Rearing* (M00065).



Shown on hive  
(hive not included)



M01320

### BENEFITS OF OUR QUEEN REARING SYSTEM

- 5 MINUTES to transfer eggs or larvae into 420 queen cells
- WITHOUT TOUCH! Our transfer of eggs or larvae makes this system unique to the industry
- No need for individual grafting
- Advanced technology utilizing easy-step lay cage design for high yield production of queen bees
- The EZI-Queen System comes ready to assemble for the hive

### WITH OUR EZI-QUEEN REARING SYSTEM

- ✓ eggs are layed out within 4 hours
- ✓ eggs hatch to larvae within 72 hours and in 12 days your queens are ready to emerge

#### Queen Bee Rearing System includes:

- 1-Lay Cage Unit
- 1-Front Cover
- 1-Front Cover Plug
- 1-Rear Cover
- 42-SNAP-OFF Plug Strips (10 plugs per strip)
- 21-Cell Bars
- 420-Individual Queen Cells
- Instruction Manual

#### EZI Complete System

Trap the queen with our push-in style cage and mark her as you normally would. No need to remove her from the frame. Less stress than other models.

**M01320** EZI Complete System Ship wt. 5 lbs. . . . . \$260.55

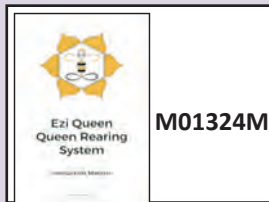

M01324M

#### EZI Queen Manual

Instructional manual on how to use the EZI Queen Systems.

**M01324M** EZI Queen Manual, Ship wt. 1 lb. . . . . \$16.45

#### Replacement Parts for EZI Queen System

- M01321** 42 SNAP-OFF Plug Strips Ship wt. 1 lb. . . . . \$22.60
- M01322** 420 Queen Cells Ship wt. 2 lbs. . . . . \$64.55
- M01323** Aluminum Bar (2 pc) Ship wt. 1 lb. . . . . \$5.25



#### Queen Paint Markers

Use the correct color for the year your queen was introduced.

White - 2021, Yellow - 2022, Red - 2023, Green - 2024, Blue - 2025

Ship wt. 3 ozs. ea

- M01315** Yellow (2022) . . . . . \$8.10
- M01316** Blue (2025) . . . . . \$8.10
- M01317** White (2021) . . . . . \$8.10
- M01317G** Green (2024) . . . . . \$8.10
- M01318** Red (2023) . . . . . \$8.10



M00661

#### Queen Cage with large opening

The queen cage features a tapered candy tube, large overall opening, and secure closing mechanism for ease in use.

Ship wt. 3 ozs.

- M00661** Queen Cage
- 1-99 . . . . . \$ .36 ea.
- 100+ . . . . . \$ .30 ea.

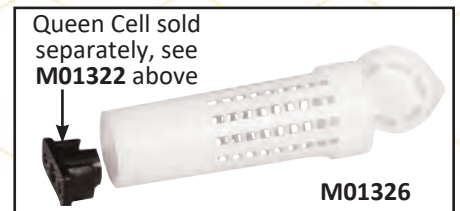

M01326

Queen Cell sold separately, see M01322 above

#### Queen Cell Protector

Queen cell protectors are to be used over the queen cells so emerging queens are confined. To be used with the EZI Queen System

- M01326** Queen Cell Protector C/10, Ship wt. 4 ozs. . . . . \$8.10

# QUEEN REARING TOOLS

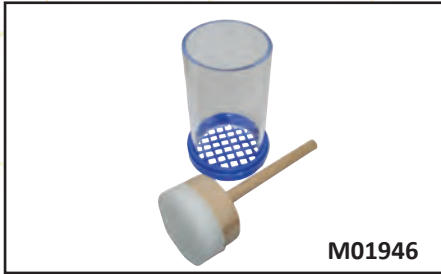

M01946

## Queen Marking Cage with Plunger

This queen marking cage will help you successfully mark your queens. Trap the queen in the cage and use the cushioned plunger to get her in place to mark. Use one of our queen marking pens to finish the job.

M01946 Queen Marking Cage w/Plunger  
Ship wt. 8 ozs. . . . . \$5.75

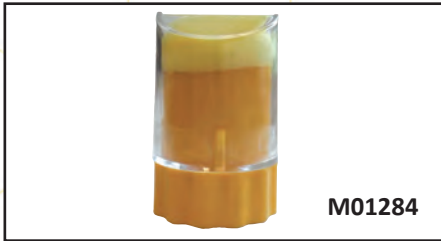

M01284

## German Plunger

Great tool for marking queens. Gently place queen inside plunger and push toward the top. When in place use a marking pen to correctly mark her.

M01284 German Plunger  
Ship wt. 8 ozs. . . . . \$5.75



M00653

## Queen Clipping Scissors

M00653 Queen Clipping Scissors  
Ship wt. 4 ozs. . . . . \$18.60

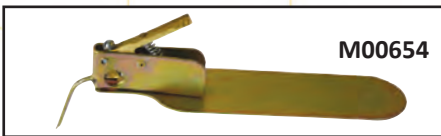

M00654

## Master Grafting Tool

M00654 Master Grafting Tool  
Ship wt. 3 ozs. ea. . . . . \$49.80

M00655 Extra Tongues,  
Ship wt. 1 oz. ea. . . . . \$5.65



M00605

## One-Handed Queen Catcher

This one-handed queen catcher makes picking up your queen by hand to mark a breeze. Safe and easy to operate.

M00605 One-Handed Queen Catcher  
Ship wt. 1 lb. . . . . \$17.45



M00658

M00659

## Queen Clip Catchers

Clips safely hold queen while working the hive. Designed so that worker bees can have full access to her.

Available in plastic or stainless steel.

M00658 Stainless Steel Queen Clip Catcher,  
Ship wt. 2 ozs. ea. . . . . \$6.95

M00659 Plastic Queen Clip Catcher,  
Ship wt. 8 ozs. ea. . . . . \$5.75

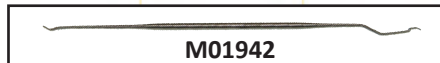

M01942

## Economy Stainless Steel Grafting Tool

M01942 Economy SS Grafting Tool  
Ship wt. 2 ozs. . . . . \$17.25

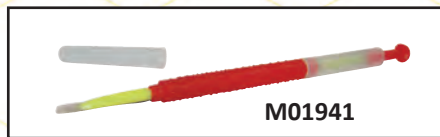

M01941

## Plastic Grafting Tool

After many requests, here it is. The Chinese grafting tool is one of the easiest to use. The thin plastic tip slides up and under larvae and releases them when the end is pushed.

M01941 Plastic Grafting Tool  
Ship wt. 8 ozs. . . . . \$3.95



M01947

## Push-In Queen Marking Cage

Trap the queen with our push-in style cage and mark her as you normally would. No need to remove her from the frame. Less stress than other models.

M01947 Push-In Queen Marking Cage  
Ship wt. 8 ozs. . . . . \$2.25



M01505

## Entrance Disc

Using our entrance disc in your nuc operation allows you to have 2 entrances: one with a queen excluder opening; the other is wide open so the bees can come and go as they please. A third option is vented for moving bees from one location to another. Screws not included.

M01505 Entrance Disc  
Ship wt. 1 lb. . . . . \$3.35

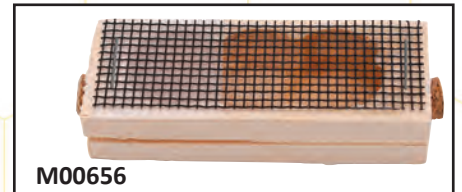

M00656

## Wood Mailing Cages

(Without Candy) Carton of 100.

M00656 Wood Mailing Cages  
Ship wt. 5 lbs. . . . . \$58.85



V01999

## Queen Muff

Are you tired of losing queens when releasing the attendants? If you are, our queen muff is for you!

V01999 Queen Muff  
Ship wt. 1 lb. . . . . \$19.50

# QUEEN REARING SUPPLIES

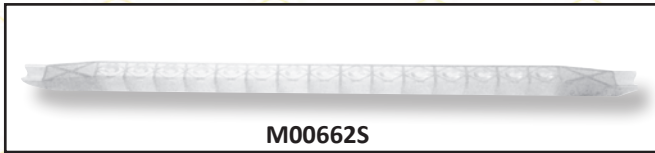

## Smokey Cell Bar

The smokey cell bar holds 15 wide based cell cups. Attach bar to standard frame and place in cell building colony.

**M00662S** Smokey Cell Bar  
Ship wt. 2 ozs. ea. . . . . \$2.30

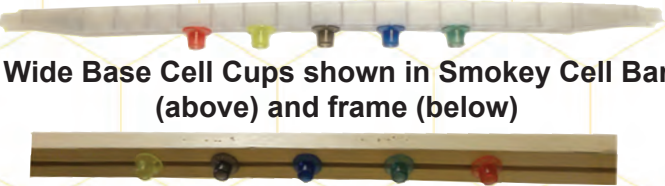

Wide Base Cell Cups shown in Smokey Cell Bar (above) and frame (below)

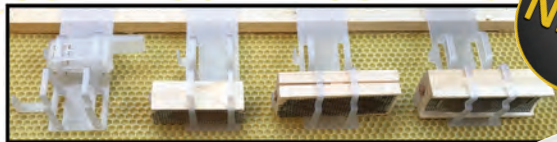

**NEW!**

## Queen Cage Holder

### Fast, Easy, Accurate Placement of a Queen Cage.

Made from durable, yet flexible plastic which will last years. Each cage comes with instructions on how to use.  
Ship wt. 2 ozs. ea.

**M00679** Queen Cage Holder,  
1-4 . . . . . \$5.35  
5-24 . . . . . \$5.10  
25+ . . . . . \$4.65



Check out the video here!



## Plastic Queen Cell Cups—2 Styles



### Push-In Cell Cups

**M00663S** Smokey  
**M00663A** Amber c/100, Ship wt. 8 oz.  
**M00663R** Red 1-9 c/100 . . . . . \$11.95  
**M00663G** Green 10+ c/100 . . . . . \$9.65  
**M00663B** Blue



### Wide Base Cell Cups

**M00664S** Smokey  
**M00664A** Amber c/100, Ship wt. 10 oz.  
**M00664R** Red 1-9 c/100 . . . . . \$11.95  
**M00664G** Green 10+ c/100 . . . . . \$9.65  
**M00664B** Blue

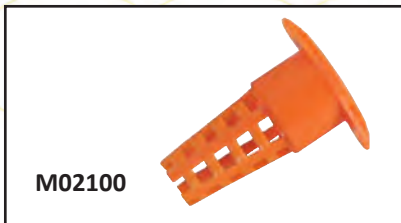

## Top Bar Cell Protector

Hangs between top bars for easy access in and out of the hive.

**M02100** Top-bar Cell Protector c/100, Ship wt. 1 lb. . . . . \$11.95  
**M02100M** Top-bar Cell Protector c/1000, Ship wt. 1 lb. . . . . \$113.25



## Push in Cell Protector

Push in for protection anywhere on drawn comb.

**M02101** Push-in Cell Protector c/100, Ship wt. 2 ozs. . . . . \$11.95  
**M02101M** Push-in Cell Protector c/1000, Ship wt. 2 ozs. . . . . \$91.00



## Candy Cap

Use with our queen cage to help keep queens from emerging too early.

**M02102** Candy Cap c/100, Ship wt. 1 lb. . . . . \$11.65  
**M02102M** Candy Cap c/1000, Ship wt. 1 lb. . . . . 104.95



## Grafting Tool

**M00652** Grafting Tool  
Ship wt. 3 ozs. . . . . \$4.60

## Queen Shipping Carton

Protects queen cells during shipment. Holds 20 queen cells. Ship wt. 1 lb. ea.

**M02103** JZ BZ Queen Shipping Carton,  
1-9 . . . . . \$4.10  
10 & Up . . . . . \$3.45

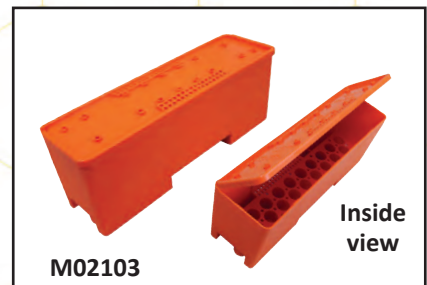

QUEEN REARING

# ALL SUITS, JACKETS, TROUSERS — UNISEX SIZES



V01260L

V01260S

## Suit

- V01260S – Small
- V01260M – Medium
- V01260L – Large
- V01260XL – X Large
- V012602XL – 2X-Large

**\$139.<sup>00</sup>** each

V01260 Suit,  
Ship wt. 5 lbs.

## Jacket

- V01261S – Small
- V01261M – Medium
- V01261L – Large
- V01261XL – X Large
- V012612XL – 2X-Large

**\$113.<sup>25</sup>** each

V01261 Jacket,  
Ship wt. 3 lbs



V01261L

V01261M



## Economy Vent Suit and Jacket

We are pleased to offer an economy ventilated suit and jacket. Three layers of ventilated netting are sandwiched together to provide you with optimum protection while allowing ultimate air flow keeping you well protected and cool. The suit offers extra padding at the knees, two chest pockets, two hive tool pockets, and side pockets. The jacket offers two chest pockets and two pockets by the waist. This suit also offers elastic wrists, elastic/zippered ankles and an elastic thumb hold. The ultimate in economy ventilated clothing.



V01250M

## Suit

- V01250S – Small
- V01250M – Medium
- V01250L – Large
- V01250XL – X Large
- V012502XL – 2X-Large

**\$159.<sup>60</sup>** each

V01250 Suit,  
Ship wt. 7 lbs.

## Jacket

- V01251S – Small
- V01251M – Medium
- V01251L – Large
- V01251XL – X Large
- V012512XL – 2X-Large

**\$118.<sup>40</sup>** each

V01251 Jacket,  
Ship wt. 5 lbs.



V01251M

V01251S



Close-up of suit material

## Ventilated Suit and Jacket

We are pleased to offer what we feel is the finest vent suit and jacket in the industry. Synthetic foam is sandwiched between 100% polyester mesh making this suit the coolest, most ventilated suit available on the market. The hat veil features an adjustable Velcro strap to help insure a true fit. Elastic cuffs around the wrist and ankles. Ankles are zippered for easy on/off. Two large pockets on front waist area and one on front chest provide room for needed tools. Suit has extra padding at the knees. Jacket offers elastic around the waist along with two large pockets and one large pocket on chest.

# BEEKEEPING SUITS

## Dadant Zipper Veil Suit



**Zipper Veil-Suit Combination** was designed by *Dadant & Sons*. We added all the features our beekeepers wanted for total protection and comfort for a full day's work in the bee yard. This Zipper Veil-Suit Combination offers the fine features of the Dadant Folding Veil and the Dadant Coveralls to provide total protection for the beekeeper. Zippered side openings allow full protection and easy access to trouser pockets. Easily slip on over boots or shoes with generous zippered bottom pant legs. The location of the veil zipper holds the veil in place assuring perfect vision while allowing total freedom of movement. Easy on and off. We recommend using with the Dadant Plastic Sun Helmet. When ordering, state catalog number and size. Because of numerous sizes, branch locations may be temporarily out-of-stock on some sizes. Ship wt. 4 lbs.

**Helmet not included,  
(sold separately  
on page 73)**

- M01103 – Small
  - M01105 – Medium
  - M01107 – Large
  - M01203 – X-Large
  - M01203X – 2X-Large . . . . . \$89.50
- \$85.<sup>75</sup>  
each**

## Snow-White Coveralls



Dadant coveralls are a snow-white, polyester-cotton blend. Snow-white because white is less annoying to bees than darker colors and they are less apt to sting. Full front zipper for easy on and off. Sturdy construction - all points of stress are bartacked for extra reinforcement. Six roomy pockets hold the tools you need. Side openings allow easy access to trouser pockets. Ship wt. 4 lbs. ea.

- M01063 – Small
- M01065 – Medium
- M01067 – Large
- M01121 – X-Large
- M01122 – 2X-Large

**\$58.<sup>30</sup> each**



M01060

## Boot Bands

Stop bees from crawling up pant legs. Sturdy 2" wide x 14½" long bands with velcro are used to tighten pant legs against boots. Easy on and off. Boot bands are a must when wearing pants without elastic in the cuffs.

- M01060 pair,  
Ship wt. 2 oz. ea. . . . . \$4.50
- 12+ pairs ea. . . . . \$4.35

## Cricket Style Hat & Veil Suit



- V01230S – Small
- V01230M – Medium
- V01230L – Large
- V01230XL – X-Large
- V01230XXL – 2X-Large
- V01230XXXL – 3X-Large
- V01230XXXXL – 4X-Large

**\$108.<sup>10</sup> each**

## Cricket Style Jacket

- V01231S – Small
- V01231M – Medium
- V01231L – Large
- V01231XL – X-Large
- V01231XXL – 2X-Large
- V01231XXXL – 3X-Large
- V01231XXXXL – 4X-Large

**\$82.<sup>35</sup> each**



Added Material at Elbows

V01231M

## Dadant Cricket Style Hat & Veil Suit and Jacket

We are pleased to offer both cricket style suits and jackets with polyscreen crush resistant veil. Both suits and jackets are made of a blend of polyester/cotton material. These are the ultimate in protection with added material in the knees and elbows. Suit offers a rear zippered pocket and two large front pockets which give plenty of room to carry what is needed in the beeyard. Ankles are zippered for easy on and off.



side view - hat flips back

**COMFORTABLE HAT/VEIL FITS ALL WITH SPRING STEEL BAND RINGS TO KEEP THE VEIL OUT AWAY FROM THE HEAD.**

V01220M

**Hat-Veil Combo with Poly/Cotton Zippered Jacket**

Featuring: Front zipper with elastic cuffs and waist and a zippered chest pocket. Easy to zip on and off for that quick hive inspection.

- V01220S – Small
- V01220M – Medium
- V01220L – Large
- V01220XL – X-Large
- V01220XXL – 2X-Large
- V01220XXXL – 3X-Large
- V01220XXXXL – 4X-Large

**\$77.<sup>20</sup> each**



V01220MP

**Poly/Cotton Trousers**

Our adult trousers are a nice compliment to our Hat-Veil Combo Jacket and Hooded Poly/Cotton Jacket. These trousers feature two large front pockets with velcro closures and an extra hive tool pocket on each side. The waist is a very stretchable elastic with front zipper and button up front. Zippered legs for easy on and off.

- V01220SP – Small
- V01220MP – Medium
- V01220LP – Large
- V01220XLP – X-Large
- V01220XXLP – 2X-Large

**\$41.<sup>15</sup> each**



V01170S

V01170M

**Hat-Veil Combo with Poly/Cotton Suit**

Featuring: Leg zippers for easy on/off, two front side pockets and a chest pocket. Comfortable hat/veil combo with zipper attachment, elastic leg and wrist cuffs.

- V01170S – Small
- V01170M – Medium
- V01170L – Large
- V01170XL – X-Large
- V01170XXL – 2X-Large
- V01170XXXL – 3X-Large
- V01170XXXXL – 4X-Large

**\$90.<sup>60</sup> each**



V01200M

For quick trips to the bee yard, a practical hooded jacket gets the job done. Secure, safe and cool.

**Hooded Poly/Cotton Jacket**

- V01200S – Small
- V01200M – Medium
- V01200L – Large
- V01200XL – X-Large
- V01200XXL – 2X-Large

**\$67.<sup>95</sup> each**

**QUALITY IMPORTED AT GREAT PRICES!!!**

*Classic Hooded Design...* but with a difference! Our polyester cotton blend is double lined with 2 full layers to protect the back of the head. Give yourself confidence, full vision and rugged Dadant quality with our newest Protective Bee Suits.

- *Heavy-Duty Zippers*
- *Unobstructed Vision*
- *Relaxed Fit*
- *Elastic Waist*
- *2 Lg Chest Pockets*
- *Rugged Quality*
- *Easy On & Off*



Closeup of embroidered logo

**Improved Hood Design**



Zippered Leg Cuffs

V01180M

**Hooded Poly/Cotton Suit**

- V01180S – Small
- V01180M – Medium
- V01180L – Large
- V01180XL – X-Large
- V01180XXL – 2X-Large

**\$92.<sup>65</sup> each**

Note sizes are based upon chest sizes. Jacket ship wt. 3 lbs., Trouser ship wt. 3 lbs., Suit ship wt. 5 lbs.

# VENTILATED SUIT & JACKETS



## Beige Ventilated Jacket

Our partial vent suit and jacket went over so well we thought we'd bring it to you in beige. This stylish jacket will help hide those unwanted stains picked up during trips to the bee yard. Comes in sizes Small – 4x-Large.

- V01254S – Small
- V01254M – Medium
- V01254L – Large
- V01254XL – X-Large
- V012542XL – 2X-Large
- V012543XL – 3X-Large
- V012544XL – 4X-Large

**\$77.<sup>20</sup>**  
each  
any size



V01265



V01266

## Ventilated Suit

- V01265S – Small
- V01265M – Medium
- V01265L – Large
- V01265XL – X-Large
- V012652XL – 2X-Large
- V012653XL – 3X-Large
- V012654XL – 4X-Large

**\$102.<sup>95</sup>**  
each

We are pleased to be the first to offer a partially ventilated suit and jacket. The ventilation areas are located along your sides running from your waistline to your wrist in the jacket. The jacket offers 4 front pockets two with Velcro and the other open for quick access. The full suit is ventilated on the outside of the legs starting at the ankles and ending at the wrist. The hood is fully ventilated on both the suit and jacket. Optimum air flow in the right places make this suit and jacket perfect for your trips into the bee yard.

## Ventilated Jacket

- V01266S – Small
- V01266M – Medium
- V01266L – Large
- V01266XL – X-Large
- V012662XL – 2X-Large
- V012663XL – 3X-Large
- V012664XL – 4X-Large

**\$77.<sup>20</sup>**  
each

# CHILDREN'S SUITS, VEILS & GLOVES

PROTECTIVE CLOTHING



V01265C8

## Children's Ventilated Suit



Our partially ventilated adult suit was such a hit we had it copied for our children's suit as well. With protection and ventilation in the proper areas this suit is the best children's suit we have seen to date.

**V01265C4** Child's Two-Piece Suit Age 4-6,  
Ship wt. 3 lbs. ea **\$79.95**

**V01265C8** Child's Two-Piece Suit Age 8-12,  
Ship wt. 3 lbs. ea **\$79.95**



V01265C4

## Children's Hat-Veil Combo with Poly/Cotton Jacket

Our jacket for 10-12 year-old children features a zippered chest pocket with elastic cuffs and waist. Easy to slip on and off for the quick trip to the bee yard with mom and dad.

**V01220C** Children's (10-12)  
Ship wt. 3 lbs. ea. .... **\$77.20**



Children's Jacket  
V01220C

Children's Trousers  
V01220CP

Jacket and Trousers  
Sold Separately

## Children's Poly/Cotton Trousers

Our children's trousers are a nice addition to our child's jacket. Featuring a front pocket with elastic waist and ankles. These trousers will give your youngster the extra protection they may sometimes need in the bee yard. Ship wt. 3 lbs. ea.

Children's (10-12)  
**V01220CP** ..... **\$34.95**

## Children's Hat-Veil Combo with Poly/Cotton Suit

Children's (10-12)  
**V01170C** Ship wt. 5 lbs. .... **\$90.60**



V01170C  
Side view

## Child's Two-Piece Suit Ages 4 & 6

We are pleased to offer a 4 year old and 6 year old jacket and pants combo. Trousers offer one pocket in front along with elastic around the ankles and loop to go underneath your child's feet to hold them in place. Jacket offers a single front pocket for their own pocket hive tool. Full zipper around neck area makes taking the veil off a breeze. Full zippered front. The best protection for your child's first visits to the bee yard. **Boots not included.**

**V01244E** Child's Two-Piece Suit Age 4,  
Ship wt. 3 lbs. ea. .... **\$77.20**

**V01246E** Child's Two-Piece Suit Age 6,  
Ship wt. 3 lbs. ea. .... **\$77.20**



V01244E

V01246E

Boots not included

## Dadant Child's Folding Veil

This popular style veil is both cool and convenient to wear. Open mesh netting top and seamed wire netting face, side, and neck panels make for easy folding. Open mesh netting skirt for maximum protection and coolness. Available in adult size on the next page. **Helmets not included.**

Ship wt. 1 lb.  
**V01096** Child Size ..... **\$17.95**

Helmet  
Sold Separately



V01096

## Child's Ventilated Leather Gloves

We are pleased to offer this top quality glove at a great price. The hand is made of top grain cowhide leather. Heavy duty rubberized gauntlet bell cuff with 100% nylon, full circular ventilation panel is firmly stitched between glove and sleeve for extra coolness on hot days. Lighter weight elbow length canvas drill sleeves with elastic band at the top provides good protection with a cooler material. Ship. wt. 1 lb.

**M011382C** Child's Ventilated Leather Gloves ..... **\$25.70**



M011382C



# DADANT VEILS

Quality Materials—Quality Workmanship

## Dadant Folding Veil

(All veils and helmets sold separately)

This popular style veil is both cool and convenient to wear. Open mesh netting top and seamed wire netting face, side, and neck panels make for easy folding. Open mesh netting skirt for maximum protection and coolness. Available in adult w/drawstring, child's w/drawstring, and with attached zipper that allow this to be sewn onto your favorite suit. **Helmets not included.** Ship wt. 1 lb.

- V01093** Folding Veil w/Bottom Drawstring—Adult Size . . . \$17.95
- V01100** Folding Veil w/Bottom Zipper—Adult Size . . . . . \$19.50



Folding Veil



Alexander Veil

## Dadant Alexander Veil *Best Value*

The Alexander Veil has a durable white cloth top that forms the hat. Full-vision, round one-piece screen-wire veil - no helmet needed. Inner elastic headband holds veil in position so top does not touch the head. Cloth top extends down back of veil to form sunshade for the neck. Long tie-down drawstring.

- V01090** Alexander Veil, Ship wt. 1 lb. ea. . . . . \$21.60

## Dadant Excelsior Veil

A wire veil of one-piece round construction allows clear view in all directions. Double-seamed, open mesh netting, top and bottom. Elastic top. Bottom drawstring. Cool. Fits our helmet's and most hats. **Helmets not included.**

- V01094** Excelsior Veil, Ship wt. 1 lb. ea. . . . . \$18.10



Excelsior Veil



Tulle Veil

## Dadant Tulle Veil

Tulle Veil uses clear-vision fabric that is really cool. Elastic cord at bottom and top so veil will fit any hat. This veil is the lightest weight and easiest to carry of all. Fold and put it in your pocket. Great for any outdoor activity! Keeps away mosquitos, black flies and gnats. Fits our helmet and most hats. **Helmet not included. Works best with ventilated or plastic sun helmets.**

- V01092** Tulle Veil, Ship wt. 4 ozs. ea. . . . . \$13.35

## Pullover Veil

This pullover veil is perfect for quick inspections when donning full protective gear isn't warranted. Great for times you are just wanting to peek in the hive or as a spare veil for interested visitors.

- V01103** Veil, Ship wt. 1 lb. ea. . . . . \$46.30

## Hat Veil Pullover Combo

A new slip-on hat/veil combination features the same polyscreen material used in our polyscreen folding veil. Ideal for a quick inspection—simply slip it on and go. Wide brim hat holds veil out from the face.

- V01108** Hat Veil Pullover Combo, Ship wt. 2 lbs. ea. . . . . \$30.85



Pullover Veil



Hat Veil Pullover Combo

# BEEKEEPING HATS

## Dadant Plastic Sun Helmet

**Dadant Plastic Sun Helmet**—We designed it with you in mind. Molded of gleaming white plastic, the full wide brim holds the veil away from your face. Side louvers allow maximum circulation of air around the head. Adjustable inner headband fits all head sizes and holds the helmet away from the head for even more air circulation. Ideal combination with any of our veils or wear it around the yard and garden for cool protection from the sun. Ship wt. 2 lbs.

*Our plastic sun helmet was designed for the prevention of the Apis mellifera honey bee from entering. Caution: other smaller breeds may be able to enter.*

- M01049 or M01049S**
- 1-29 . . . . . \$11.60
- 30-49 . . . . . \$10.20
- 50-199 . . . . . \$9.25
- 200-499 . . . . . CALL
- 500 & Up . . . . . CALL

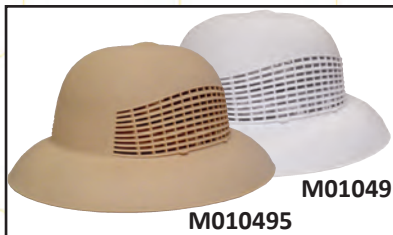

M01049 M01049S

## Ventilated Sun Helmet

**Ventilated Sun Helmet**—Woven open mesh material is strong and lightweight. Allows maximum circulation of air. Adjustable headband. Water-resistant. Available in either tan or white. Ship wt. 2 lbs. ea.

- M01087** Tan . . . . . \$23.75
- M01087W** White . . . . . \$23.75

## Sweat Band



**M01088** Sweat Bands  
Ship wt. 2 ozs. ea. . . . \$4.65



M01087W M01087

# DADANT FOLDING VEIL USA

**Back by Popular Demand!**



**V01093USA**  
with drawstring



**V01100USA**  
with zipper



**BACK BY POPULAR DEMAND.**

When you asked for it, we listened. Dadant & Sons square folding veil is once again being sewn at Dadant Headquarters from the highest quality USA sourced material. Keeping the same design they started with many years ago this veil is sure to help keep you cool. The open mesh netting top will fit most any hat or helmet. Strong seamed wire netting face, side, and neck panels are hinged at each corner to permit easy flat folding for storing when not in use. The open mesh netting skirt allows maximum protection and coolness. Available in two styles. One with a long bottom drawstring or one with an attached zipper that is ready to be sewn into your bee suit. Will fit most hats and helmets.

**Helmet not included.**

Ship wt. 1 lb.

- V01093USA** Folding Veil with Bottom Drawstring—Adult Size . . . . . **\$24.45**
- V01100USA** Folding Veil with Zipper—Adult Size . . . . . **\$22.60**

# BEEKEEPING GLOVES

## Heavy Duty Ventilated Leather Gloves with Velcro strap

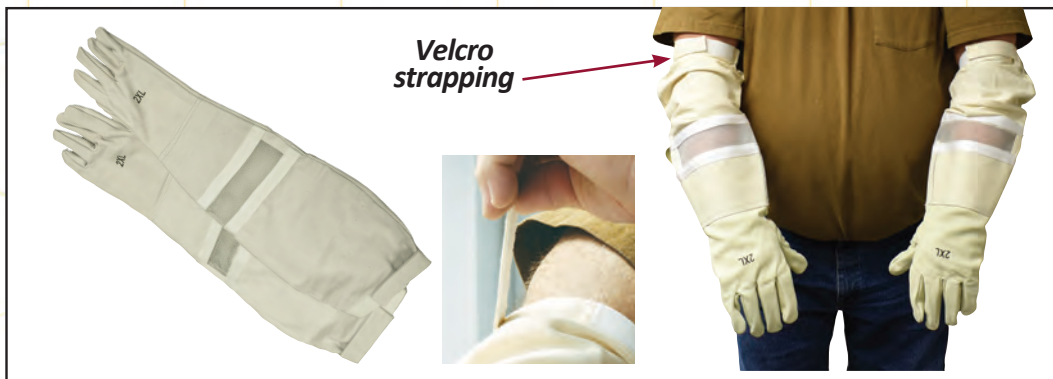

Many have come to us over the years asking for a larger opening to our gloves with better elastic. We took it one step further and have put a Velcro strap on our heavy duty ventilated gloves. Available in larger sizes only.

**M011350X** – X-Large  
**M0113502X** – 2X-Large  
**M0113503X** – 3X-Large

**\$28.<sup>25</sup>**  
each  
any size

## Ventilated Gloves

Our new ventilated gloves are for those working hot hives with hot hands. Our heavy duty ventilated leather gloves have added protection at the knuckles and finger tips with ventilation on the backside of your hands for optimum air flow. Give them a try today and see how cool these gloves really are.

**M01179S** – Small  
**M01179M** – Medium  
**M01179L** – Large  
**M01179X** – X-Large  
**M011792X** – 2X-Large

**\$27.<sup>15</sup>**  
each  
any size



## Ventilated Leather Gloves

We are pleased to offer this top quality glove at a great price. The hand is made of top grain cowhide leather. Heavy duty rubberized gauntlet bell cuff with 100% nylon, full circular ventilation panel is firmly stitched between glove and sleeve for extra coolness on hot days. Lighter weight elbow length canvas drill sleeves with elastic band at the top provides good protection with a cooler material. Ship. wt. 1 lb. State size by item number.

**M011382** – Small  
**M011372** – Medium  
**M011362** – Large  
**M011352** – X-Large  
**M011342XX** – 2X-Large

**\$27.<sup>15</sup>**  
each  
any size



# BEEKEEPING GLOVES



## Lighter Weight Ventilated Leather Gloves

A lighter weight version of our glove. Basically the same construction and same quality features. This glove incorporates a lighter weight leather for those not needing the day-to-day durability of our premium, more expensive, glove. Ship wt. 1 lb. State size by item number.

- M011381 – Small
- M011371 – Medium
- M011361 – Large
- M011351 – X-Large
- M011341XX – 2X-Large

**\$20.<sup>35</sup>**  
each  
any size



## New Goatskin Gloves

These mid weight goat skin gloves are perfect for your day in the apiary. Cotton gauntlet fits most half way between the wrist and elbow. Perfect for those with large forearms. Ship wt. 1 lb.

- M01096 – Small
- M01097 – Medium
- M01098 – Large
- M01099 – X-Large
- M01100 – 2X-Large

**\$27.<sup>75</sup>**  
each  
any size



M01086

## Plastic-Coated Canvas Glove

M01086 – Small..... \$13.80

## Yard Apron

Great for working in the honey house or the kitchen. Divided legs each have easy-to-clasp fasteners. Easy walking—Comfortable sitting. Ship wt. 3 lbs. ea.

- Ideal in the Honey House*
- Poly-Cotton Blend
  - Divided Leg Style

M01077  
Yard Apron  
1-11 \$23.75  
12 & Up \$22.60



M01077



## Rubber Gloves

This new style of rubber gloves caught our eye one day when preparing to use mite treatments on our hives. Heavy duty latex that is easy to wash. Great glove for the honey house and to wear while applying treatments to your hives. Ship wt. 1 lb.

- M01090 – Medium
- M01091 – Large
- M01092 – X-Large

**\$13.<sup>35</sup>**  
each  
any size



## Canvas Gloves

Heavy canvas gloves specially treated to make them even more sting-resistant. The full-elbow length sleeve has an elastic top. Fits snugly around the arm below the elbow. Not washable. Ship. wt. 10 ozs. State size by item number.

- M01080 – Small
- M01079 – Medium
- M01078 – Large

**\$14.<sup>70</sup>**  
each  
any size

# REMOVING BEES FROM SUPERS FILLED WITH HONEY

## *Non-Chemical Method*

### Using Bee Escapes

**Bee Escapes** are one-way doors which let the bees leave the supers but not return. The escape is placed beneath the supers of honey to be removed. (When removing more than one super of honey from an individual hive, we recommend placing an empty shallow super under the escape board to allow more space.) Supers are usually free of bees within 2 - 24 hours and no chemicals are used.

### Bee Escape Board

The Triangle escape board works like a bee escape except the bees are able to leave the super much quicker. Face the triangle covered with hardware cloth towards the bottom of the hive. Bees will exit through escapes on the side of the triangle and can't figure out how to get back in. Ship wt. 6 lbs. ea.

- M00940** Bee Escape Board 10-frame. . . . . \$18.10
- M009408** Bee Escape Board 8-frame. . . . . \$16.75

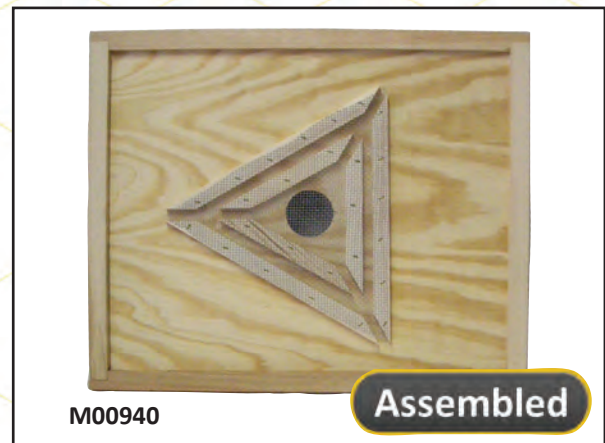

M00940

**Assembled**

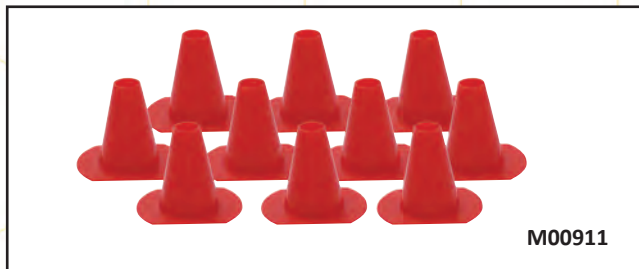

M00911

### 10 Conical Bee Escapes Only

A set of 10 conical escapes allows the operator to construct his own escape board. Ship wt. 2 ozs. ea.

- M00911** Conical Bee Escapes, Pkg/10 . . . . . \$11.85

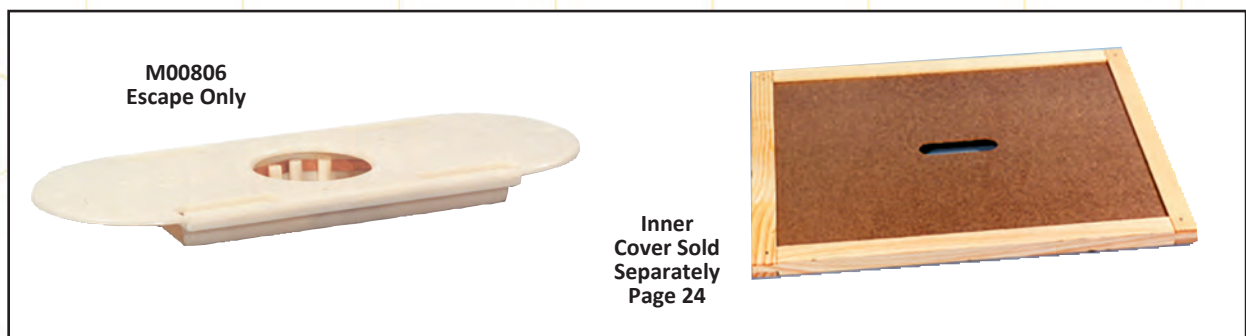

M00806  
Escape Only

Inner  
Cover Sold  
Separately  
Page 24

### Standard Bee Escape And Inner Cover

This bee escape is placed in the center opening of an inner cover (B15201) described on page 36. Ship wt. 2 ozs. ea.

- M00806** Standard Bee Escape . . . . . \$3.85
- 12+, ea. . . . . \$3.30

# REMOVING BEES FROM SUPERS FILLED WITH HONEY

## Repellent Method



**Honey-B-Gone**

Honey-B-Gone is a new, easy to use, natural oil honey bee repellent. Spray on fume boards and place on top of honey supers. Watch the bees flee.

- M00136** Honey-B-Gone, 16 fluid ozs., Ship wt. 2 lbs.. **\$26.55**
- M00136G** Honey-B-Gone, 1 gallon, Ship wt. 12 lbs. **\$162.15**



**Bee Dun**

Bee Dun is the beekeepers friend at harvest time. Made out of a pleasant smelling combination of natural oils, this is really the way to remove bees from your honey supers. 8 oz. bottle. Ship wt. 1 lb. ea.

- M00135** Bee Dun, 8 fluid ozs. .... **\$18.65**



**Bee Go**

**Bee Go** — Approved chemical that quickly chases bees from honey supers on hot or cold days - early morning to late evening. Use fume pad **M60070** and **M60078**. 1 and 5 gallon cans ship Freight Only—Hazardous price on shipping will apply — call for quote. Additional charges may apply. Pint size is for pick-up only—cannot be shipped by ground. (see *Honey-B-Gone* or *Bee Dun* which can be shipped).

- ⊗ M00130** Bee Go, 1 Pint, Ship wt. 3 lbs. ea. .... **\$20.55**  
Case of 30, Ship wt. 60 lbs. ea. .... **\$19.50**
- ⊗ M00131** Bee Go, 1 Gallon, Ship wt. 15 lbs. ea.. **\$123.55**  
Case of 5, Ship wt. 85 lbs. ea. .... **\$119.45**
- ⊗ M00132** Bee Go, 5 Gallons, Ship wt. 60 lbs. ea.. **\$350.15**



**Black Fume Pad - 10-Frame**

We offer two styles of fume pads for your needs. This 10-Frame black topped fume pad will help capture the sun's rays to speed up the process of moving honeybees out of your supers full of honey. Apply fumigant on underside of pad. Ship wt. 5 lbs

- M60070** 10-frame Black Fume Pad. .... **\$18.50**
- M600708** 8-frame Black Fume Pad. .... **\$18.70**

**Black Fume Pad - 8-Frame**



**M600708**

# UNCAPPING PRODUCTS

## Uncapping Fork

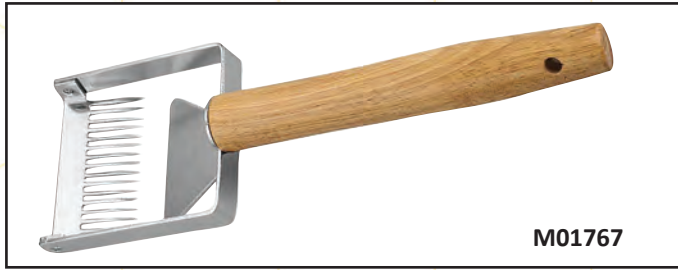

Our new uncapping fork/scrapper is a great tool to have in the honey house. These sharp needles will penetrate your wax capping providing a clean cut every time.

**M01767** Uncapping Fork, Ship wt. 1 lb. . . . . \$20.55

## Uncapping Plane

**Electric Uncapping Plane**—Perfect tool for small or large operations. UCP has an adjustable heated copper cutting blade for depth of cut. The heating element is long lasting and replaceable. On/off switch built into cord. The large comfortable rock maple handle is comfortable to use. Just pull the UCP across the combs and feel the difference. UCP 110V, right hand.

**M00335** Uncapping Plane, Ship wt. 8 lbs. . . . . \$164.75

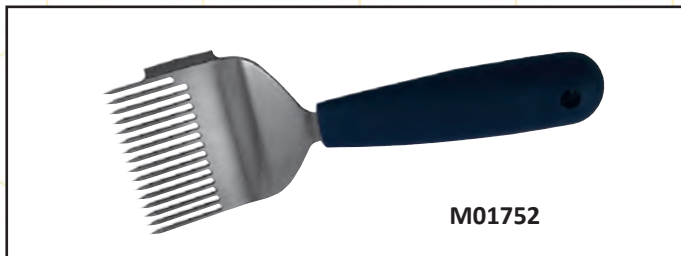

## Stainless Steel Cappings Scratcher

High quality one piece stainless steel cappings scratcher with blade to remove burr comb from top bars. Molded rubber handle.

**M01752** Stainless Steel Cappings Scratcher, Ship wt. 8 ozs. . . . . \$30.85



## Serrated Comb Honey Knife

**Serrated Comb Honey Knife** —The best comb cutting knife we have found. This extremely sharp and serrated knife makes slicing through comb a breeze.

**M00336** Serrated Comb Honey Knife, Ship wt. 1 lb. . . \$14.70

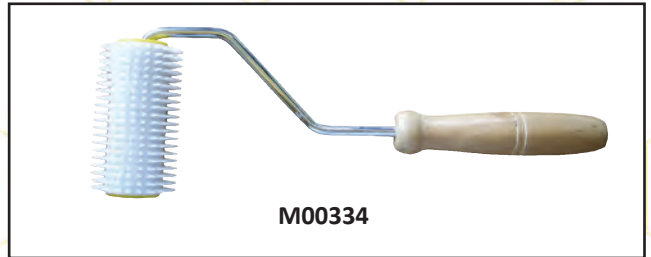

## Uncapping Roller

This 4" uncapping roller will help you uncap faster than ever before. Made of food-grade plastic.

**M00334** Uncapping Roller, Ship wt. 1 lb. . . . . \$23.65

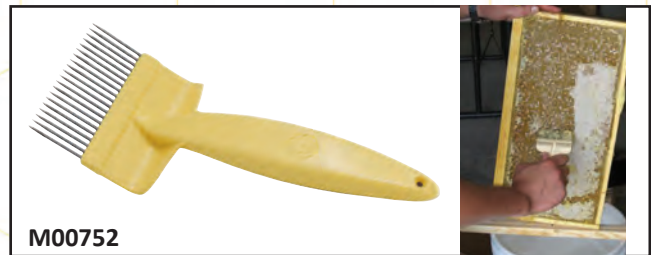

## Cappings Scratcher

Cappings Scratcher, the only “uncapping tool” used by many hobby beekeepers. An excellent hand tool for opening the cells to let the honey out. 20 sharp needles molded into high strength plastic. A must in every honey house. Colors may vary.

**M00752** Cappings Scratcher, Ship wt. 8 ozs. . . . . \$9.65  
12 or more, . . . . . \$9.30  
Ship wt. 5 lbs. per 12 ea.



## Serrated Uncapping Knife

The best “cold” uncapping knives we have found, the double sided serrated knife cuts through the capping very effectively.

**A high quality tool from Portugal.**

**M00338** Serrated Uncapping Knife, Ship wt. 3 lbs.. \$29.40

# UNCAPPING PRODUCTS

## Electric Uncapping Knife w/Control Unit

Blade temperature is controlled by using the knob on the control box. Set to temperature of your liking and uncap. High quality blades that are 10" long and 2" wide.

**M00343** Electric Uncapping Knife, Ship wt. 3 lbs. . . . . \$164.25



M00343

## Speed King Electric Knife

**Electric Heated Knife**—Blade temperature is controlled by built-in thermostat. 120 volt operation. Wood handles are cool on your hands. High quality blades are 10" long and 2" wide. Guaranteed by manufacturer for 1 year with all warranties handled by manufacturer.

**M00339** Speed King Electric Knife, Ship wt. 3 lbs. . . . . \$135.90

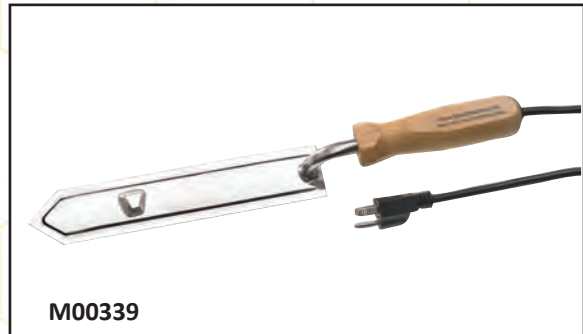

M00339

## Combcapper

The combcapper fits standard 5 gallon pails and will hold all size frames, shallow – deep. Uncap directly into your 5 gallon pail. Easy clean up. Dishwasher safe. Made in USA.

**M01366** Combcapper, Ship wt. 2 lbs. . . . . \$40.75



M01366



## Wax Pan

- Easy Wax Release
- 5 Pound Capacity
- Compression Molded Fiberglass
- Reinforced Polyester
- High Strength for Years of Service

**M00824** Wax Pan, Ship wt. 5 lbs. ea . . . . . \$51.45



M00824

## Clear Plastic Uncapping Tub

### Do You Uncap?

*How do you get the best honey out of your cappings?*

- Three piece clear uncapping tub, drainer and lid!
- Food-grade commercial restaurant quality equipment.
- Virtually unbreakable (in normal use)
- Uncap cleanly, hygienically, quickly.
- Large capacity 25"L x 18"W x 9"D uncapping tank and drainer.

**M01355** Plastic Uncapping tub  
Ship wt. 45 lbs. ea.\* . . . . . \$181.25

\*See page 144

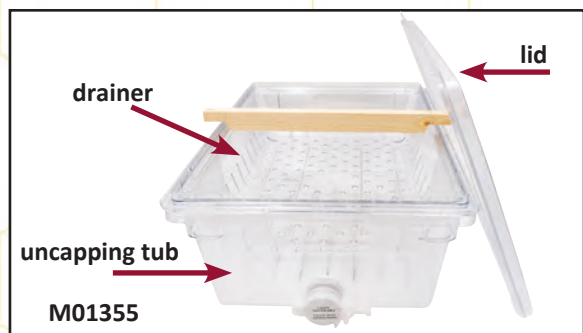

M01355



# UNCAPPING / FILTERING SUPPLIES



**M01365**

## Bucket Filter Stand - Patent Pending

Sick of not being able to top off your 5 gallon pails of honey when using the bucket strainers? Try our bucket filter stand and fill those pails to the top. Made of quality stainless steel. Ship wt. 2 lbs. ea. *Patent Pending.*

**M01365** Bucket Filter Stand . . . . . **\$29.10**



**M01312**

## Stainless Steel Double Sieve

Adjustable to fit containers up to 14" diameter. A great way to strain honey directly from your extractor. Remove wax particles and other foreign material, anywhere you need a strainer. Coarse strainer is 1000-micron mesh and the fine strainer is a 500-micron mesh. Ship wt. 3 lbs. ea.

**M01312** Stainless Steel Double Sieve . . . . **\$50.95**

## Adjustable Bottle Filler Stand

This stainless steel bottle filling stand easily connects to your workstation. With the turn of a screw your fill level is adjusted to the correct height, making filling of your containers a breeze.

**M00610** Bottle Filler Stand . . . . . **\$84.90**

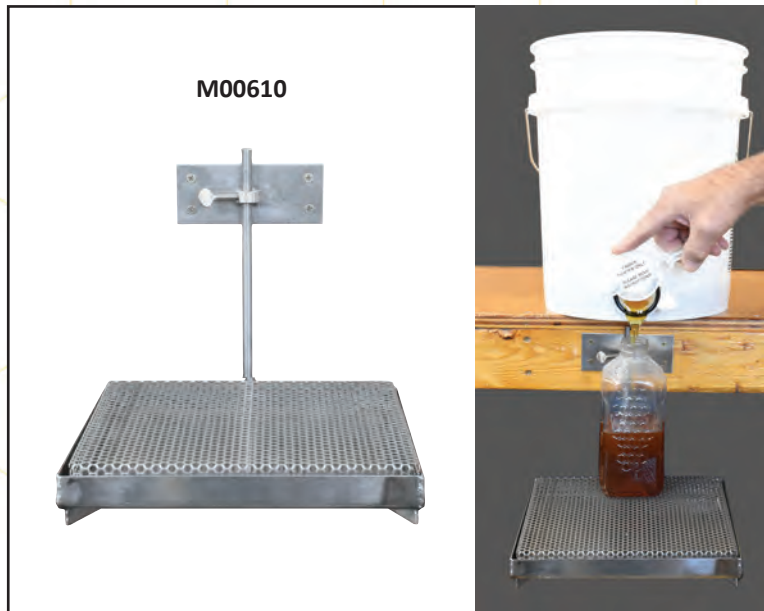

**M00610**



**M00493**

## Strainer Materials

Use with strainer screens, plastic uncapping tank or by itself. 100% cotton cheesecloth. 3 sq. yd. package. Ship wt. 1 lb. ea.

**M00493** Strainer Materials . . . . . **\$11.65**

# UNCAPPING / FILTERING SUPPLIES



M01380

## Bucket Bench

The Bucket bench is a convenient tool to drain your 5 gallon pails of honey to the last drop. Collapsible and easy to clean this is a must have tool for the honey house. Ship wt. 1 lb. ea.

M01380 ..... \$20.55



M00218

## Bottling Bucket\*

The Dadant designed 1 1/2" scissors gate installed in a heavy gauge white plastic pail makes a great unit to fill honey bottles. Gate is adjustable and cuts honey flow off cleanly. Bucket is re-inforced where bail attaches. Comes with lid. Ship wt. 5 lbs. ea.

M00218 ..... \$36.80

## BOTTLING BUCKET KIT\*

Ideal for filtering large, medium and small particles from honey. Comes complete with three reusable, washable filters. 600 micron for coarse filtering, 400 micron for medium filtering and 200 micron for fine filtering. These filters are custom designed to fit securely on the 5 Gallon Honey Bucket. Filters are 11 1/4" in diameter.

An excellent and inexpensive filter that will make your honey sparkle.

### Kit Includes the following:

- 200 Micron Fine Filter
- 400 Micron Medium Filter
- 600 Micron Coarse Filter
- 5 Gallon Pail Honey Bucket (Gate Included)
- Lid

### M01354 Bucket Kit

Ship wt. 8 lbs.  
\$55.45

Filters can be  
purchased separately



M01354



Filters are 11 1/4" in diameter.



- M01352 600 Micron Coarse,  
Ship wt. 1 lb. ea. .... \$8.10
- M01351 400 Micron Medium,  
Ship wt. 1 lb. ea. .... \$8.10
- M01350 200 Micron Fine,  
Ship wt. 1 lb. ea. .... \$8.10

\*Use of Bottling Bucket is intended for bottling only - long term storage is not recommended.



M00214

Bucket sold  
separately

## Honey Tight™ Lid

Transform your bottling bucket or 5 gallon honey storage bucket into an easy opening, airtight, pest proof container with the new Dadant Honey Tight™ Lid. When attached to the Dadant 5 gallon white plastic pail (M00212 page 110) the screw top resealable Honey Tight™ Lid protects your honey, while allowing easy access for pouring or bottling. No more prying open regular old fashioned lids. Now the lid spins off and on with just a twist.

### M00214 Honey Tight Lid

Ship wt. 4 lbs. ea ..... \$13.40

# HONEY HEATING AND MOVING EQUIPMENT AND IMPORTED EXTRACTOR

## Immersion Heaters

### Single Phase, High Quality Watlow Heaters

**Immersion Heaters** Single phase. Thermostatically controlled. Fully encased sensing tube. Highest quality materials. Not for direct contact with honey. Long life. Ship wt. 9 lbs. ea.

**M00537** 120-volt, 1700 watt heater, 1" male Pipe Thread. . . . . \$232.20

**M00361** 240-volt, 4500 watt heater, 2" male Pipe Thread. . . . . \$335.20

*Maximum temperature on all models of immersion heaters is 250°F.*



## Band Heaters

### Flexible Strip Heaters for 5 Gallon Pails and 55 Gallon Drums

**\*Pail Heater** for 5 gallon plastic pails.

**M00567** Ship wt. 4 lbs. ea. . . . . \$128.70

It will take approximately 6 hrs to bring a 5 gallon pail of honey from 70° to 125°. It is recommended that you stir the honey periodically while heating to decrease heat time.

**\*Drum Heater**—120 volt, 1750 watt, for 55 gallon drums.

**M00556** Ship wt. 17 lbs. ea. . . . . \$497.40

**\*Drum Heater**—240 volt, 3000 watt, for 55 gallon drums.

**M00557** Ship wt. 17 lbs. ea. . . . . \$497.40

**\*Special receptacle required for M00556 and M00557. Contact a qualified electrician. Plugs are pictured to the right.**



plug for M00556      plug for M00557  
Pail heater shown on pail.  
Pail sold separately.

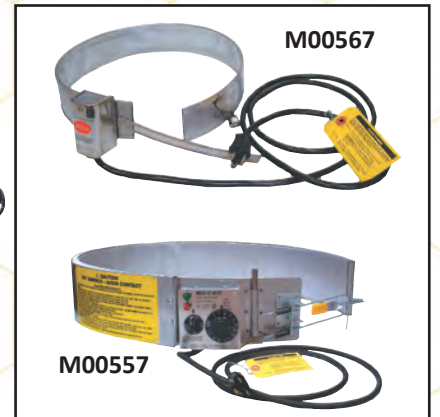

## Bee Blanket

The Bee Blanket covers a uniform heat zone giving consistent liquefying of your honey, time and time again. Cinch straps tighten the bee blanket to your pail for snug fit. 120 Volt.

**M00571** Bee Blanket  
Ship wt. 3 lbs. . . . . \$150.65



## Drum Handling Truck

Heavy-duty Drum Handling Truck takes much of the heavy work out of handling drums full of honey. Position the toes of the truck against the drum, engage movable sliding hook over edge of drum, pull back on handles and the drum tilts, allowing truck toes to slide under and engage bottom of barrel. Load is secure and ready to go. 61" high, 23½" wide. 10" wheels. **Ships Freight Only.**

**Move 55 Gallon Drums Safely and Easily**  
**Heavy Duty Construction**  
**Drum Hook Holds Top Edge of Drum**



**M00311** Drum Handling Truck,  
Ship wt. 91 lbs. ea.\* . . . . \$514.95  
*\* See page 144*

## Super Cart

We are pleased to offer another item that will come in very handy in the honey house. Our super cart comes with casters so you are able to roll it around the honey house with ease. Place up to 5 deep boxes on the cart and roll it in to extract. Ship wt. 12 lbs. **Handy in the Honey House**

**M00324** Super Cart . . . . . \$51.45



## Rubber Gasket

Rubber gaskets for sealing the lids onto 55 gallon open top barrels. Ship wt. 2 oz.

**M00755** 1-99. . . . . \$1.03 ea.  
100+ . . . . . \$ .93 ea.

## Economy Stainless Steel Extractor

This import extractor is a cheaper alternative to our US made Dadant extractors. It is the same unit that most other supply houses here in the states sell. It won't last a lifetime, but will get you started in an economical way. Two-frame basket extractor comes complete with stainless tank and gate valve. No returns after use. Ship wt. 44 lbs.

**M00385** Economy Stainless Steel Extractor . . . . . \$144.15



# HONEY HOUSE PLAN and LIQUIDATOR

## *Beekeeper Honey House Plan*

(up to 150 hives)

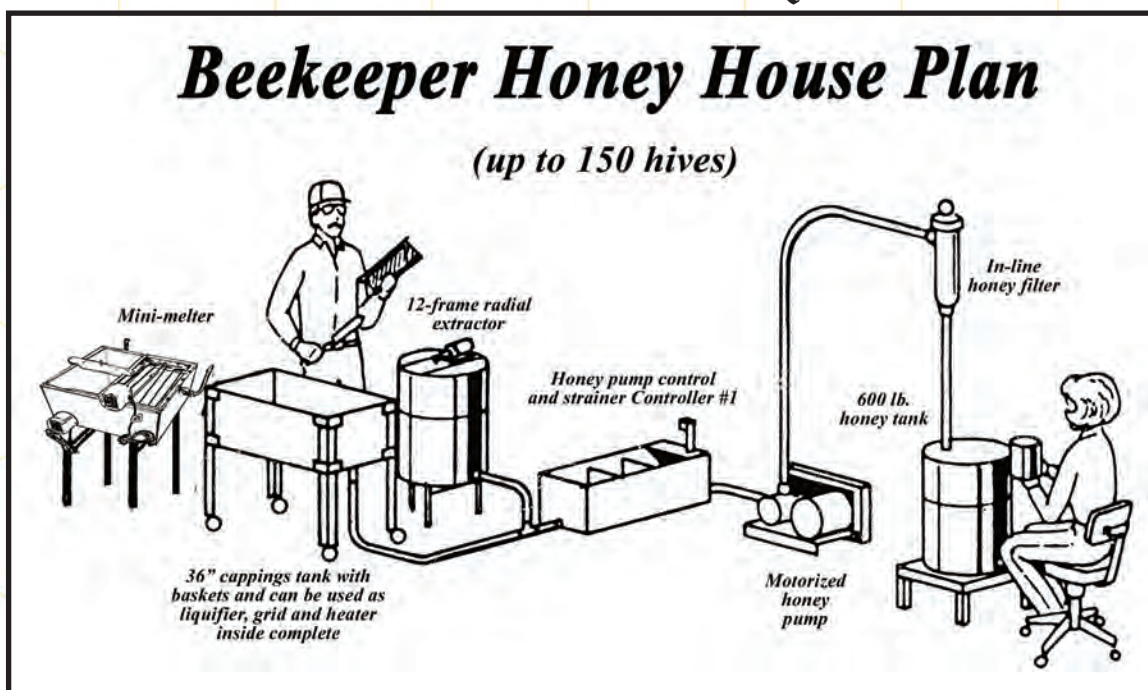

## Liquidator — 4 Units in 1 “The Hobbyist’s Dream”

- Uncapping/Cappings Drain Tank*
- Wax Melter*
- 1 Can Liquifier (60# Container)*
- 175# Bottling Tank*



### Components:

- 1 - 14" diameter, 24" deep, 24 gauge, Type 304 food-grade MIG welded stainless steel tank with two welded fittings—bottom drain.
- 1 - 1700 watt—120 volt immersion heater
- 1 - Wooden frame uncapping bar
- 1 - Heavy stainless steel support for 60# containers
- 1 - 1" bottling ball valve
- 1 - 14" diameter screen
- 1 - 14½" stainless steel spun cover

### Write or Call For Brochure With Full Operational Details

The Liquidator and an extractor are the only equipment necessary to process and package your entire honey and wax crop. The Liquidator, a great companion for your Junior Bench, Little Wonder or Ranger extractor, was developed specifically for hobbyist beekeepers. Save time, labor and mess with the Liquidator. Ship wt. 45 lbs. ea.

**M00394** The Liquidator, Complete . . . . . \$514.95

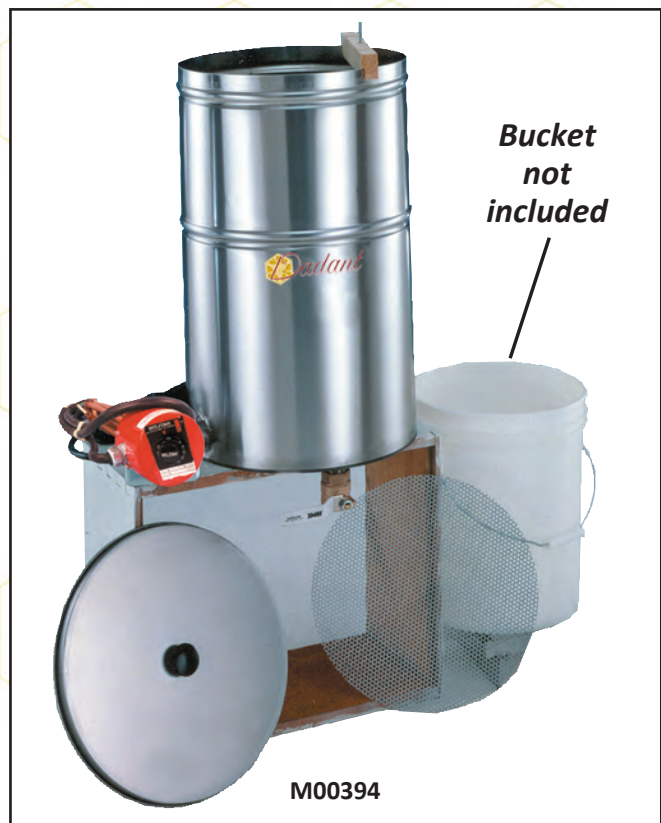

# Dadant 36" CAPPINGS TANK AND OPTIONAL EQUIPMENT



36" Cappings Tank

Tank is:  
36" Long  
18" Wide  
14" Deep

M00370



M00372

Liquifier Grid & Heater

*Liquify your honey quickly, evenly... without hassles!*

Dadant Liquifier Grid & Heater—Converts cappings tank into a 3-60# container liquifier. 1700 watt, 120 v. immersion heater screws into tank fitting and goes underneath the stainless steel 2 1/4" high container supporting grids. Fits 1983 and newer model Cappings Tanks. Grid and heater only, Cappings Tank sold separately on left. **Ships Freight Only**

✗ M00372 Grid & Heater Only, Ship wt. 63 lbs.\*. . . . . \$373.05  
\* See page 144

## 36" Cappings Tank

*Convenient wheels make moving easy*

Dadant 36" Cappings Tank—All-welded heavy type 304, 20 Gauge Stainless Steel tank. Heavy stainless legs. Casters with brakes enable you to roll uncapped frames to the extractor for loading or lock it securely in place. Holds 23 frames. Over-all height with casters - 32". The perfect start for any honey house.

**Ships Freight Only**

✗ M00370 Cappings Tank, Ship wt. 103 lbs. ea.\*. . . . . \$648.85  
\* See page 144

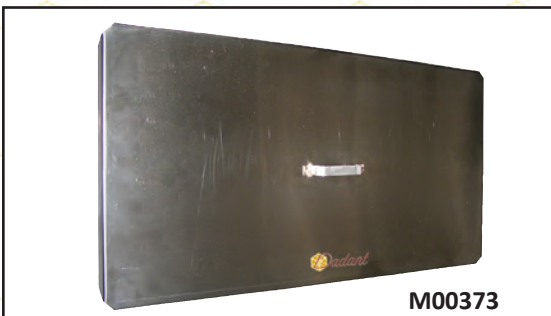

M00373

## Cappings Tank Lid

—Another Versatile System—

✗ M00373 Cappings Tank Lid, Ship wt. 15 lbs. ea.\*. . . . . \$216.25  
\* See page 144

## Cappings Baskets

*Excellent Cappings Drainage*

Dadant Cappings Baskets—Designed for use in the cappings tank. 17 1/2" x 17" Type 304, 22 gauge stainless steel construction. Uncap directly into the baskets. Perforated aluminum bottom allows good cappings drainage. Sturdy construction allows basket full of drained cappings to be lifted from the tank. Pair.

✗ M00371 Cappings Baskets (per pair), Ship wt. 17 lbs. . . . . \$216.25



Tank Not Included  
Capping Baskets Only

M00371

# WAX MELTERS

## Solar Wax Melter

**Solar Wax Melter**—The perfect answer for melting up those burr combs and small amounts of wax. Melter is 19" x 24". Works best when painted black. Comes unassembled. Inexpensive polyethylene film for top to be purchased locally.

**M00501** Solar Wax Melter,  
Ship wt. 25 lbs. ea . . . . . **\$154.45**



## Deluxe Solar Powered Wax Melter

The **ALL NEW Deluxe Solar Powered Wax Melter** is an affordable, high performance melter that uses the power of the sun to melt valuable wax with no cost to operate. It is capable of reaching and maintaining temperatures as much as 50° F above melting temperature without harmful UV ray exposure. Warm-up takes about 30 minutes and in most locations, melting can be achieved in 6-7 hours on a sunny day. Even on partly cloudy days, extended periods of melting are possible.

The Deluxe Solar Powered Wax Melter is constructed of 7-11 layer hardwood plywood which is painted black in the melting areas and polycrylic finish sealed on the exterior. It is assembled with waterproof, high strength urethane adhesive and power driven nails. Solar transfer is accomplished via multi-wall structured polycarbonate, 10mm thick sheet surrounded by a sealed wooden frame. A sliding, captive front door allows for exchanging of catch pans during the melting cycle without having to raise the main cover.

The melting and collecting areas will accommodate your pans, screen and filter cloths up to 18" x 12" x 5½" for the melting pan and up to 11" x 5" x 3" for the collecting pan. Use of aluminum pans typically sold in grocery stores and hardware outlets is recommended. Loading is easy since the cover can be completely removed providing total access to the melting area. The Deluxe Solar Powered Wax Melter can be shipped anywhere in the US or Canada.

**M00505** Deluxe Solar Powered Wax Melter,  
Ship wt. 30 lbs. ea. . . . . **\$270.30**



# Dadant's FINE FAMILY OF MELTERS

## Dadant's Water Jacketed Mini Melter

*Uncap directly into the unit*

*Draw beautiful wax from one outlet*

*Excellent quality honey from another outlet*

**Wax Melting Grid 1800 watt—120 volt**

**1700 watt—120 volt Immersion Heater for Water**

**Both Heaters Are Thermostatically Controlled**

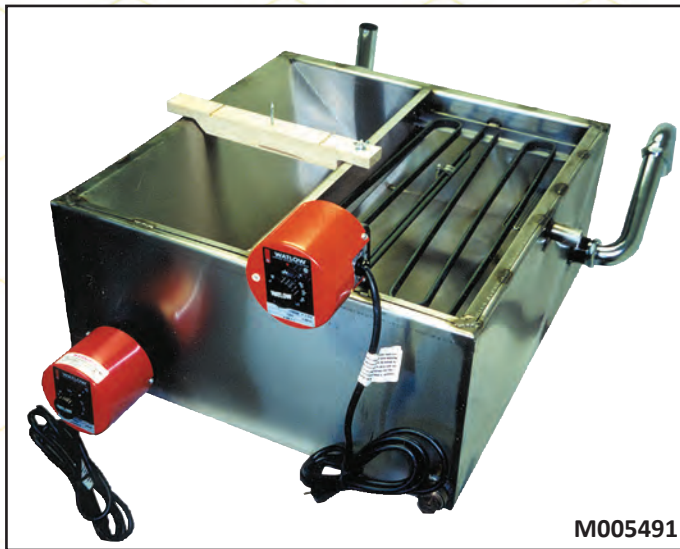

M005491

⊗ M005491 Water Jacketed Mini Melter, with Type 304, 20 gauge stainless steel, Ship wt. 105 lbs. ea.\*.....\$1,257.60

\* See page 144



M005531

M00548

Electromelt — Optional Slum Rake Shown at Right

## Dadant's Water Jacketed Electromelt



### A Proven Process

Separate Wax and Honey  
in 1 Step While You Uncap

### Eliminates Spinners

Saves Time and Money

### Optional Slum Rake System

Speeds Processing—Saves Time

### Features and Benefits of the Electromelt

- 6900 watt, 240 volt melting grid
- Stainless steel flat heating grid
- Stainless steel tank, 16 gauge
- Stainless steel water jacket
- Works with all uncappers
- Fast start up
- No steam required
- 3 year warranty on electric melting grid



The **Electromelt** has been proven by commercial beekeepers using all types of uncappers. The unit was designed for and works most efficiently with cappings from uncappers other than the chain flail type. Producers report processing cappings from over two drums of honey per hour when using the rake system with the Electromelt. At the day's end, all honey and wax are processed - no extra hours, no additional jobs to do. Quality wax is in pans, and premium honey is in storage, operating costs are low, as energy losses are minimal. When paying 8¢ per kilowatt hour, operating costs are less than 75¢ per hour. Both the melting grid and water jacket heater are thermostatically controlled for precise control. Call or write for more information.

⊗ M005531 Electromelt with Water Jacket, Type 304, 16 gauge SS, **Ships Freight Only**, Ship wt. 350 lbs. ea.\*.....\$5,718.20

\* See page 144

⊗ M00548 Aluminum Rake System, Optional, Ship wt. 70 lbs. ea.\*.....\$2,158.30

# Dadant MANUFACTURED HONEY EXTRACTORS



M00406



**NEW LEGS!**



**HAND CRANK FOR HAND EXTRACTOR**



Stainless steel wire basket

## 2-Frame Extractor

**2-Frame Extractor**—Stainless steel hand powered. Capacity: 2 frames (9 $\frac{1}{8}$ " deep maximum) per load. SS extracting basket and SS top assembly. Piano-style continuously hinged lid. Easily converts to 175-lb. storage container. (Frames must be removed and turned to extract both sides). 1 $\frac{1}{2}$ " plastic honey gate included. Tank: 24 gauge, Type 304 SS, 14" dia. x 23 $\frac{1}{4}$ " tall, all MIG welded construction. Ship wt. 25 lbs.

**M00406 2-Frame Extractor**  
..... **\$401.65**

## Food Approved Grease

**Food Approved Lubricant** for extractors, honey house equipment and other applications where it is important to avoid contamination of food products with ordinary lubricants. On the hand extractors use this to lubricate the crank handles. Also used on above hand and power units to lubricate the bottom bushing. Handy 12 oz. cartridge. Use **M009574** for 2-, 4-, and 6-frame extractors. Use **M0095712** for 12-frame and up extractors.



**M0095712**

**12 oz. Cartridge - Haynes Lubri-Film**  
Ship wt. 1 lb.

**M0095712** 1-11, ea. . \$11.30  
12+ ..... \$10.80



**4 oz. Tube - Haynes Lubri-Film**  
Ship wt. 4 ozs. ea.

**M009574** ..... \$5.10



# Dadant MANUFACTURED HONEY EXTRACTORS

## 4-Frame Extractors

**4-Frame Extractors**—Top quality tangential extractors. Extract four 9½” frames or shallow frames per load. All welded food grade stainless steel tank houses the stainless basket. Frames must be turned to extract both sides. Turn shallow frames within basket; deep frames must be lifted out for reversal. Hand models are gear driven by quiet, durable nylon gears. Power models employ a direct drive motor with an electronic speed control which is manually adjusted. 120 volt operation. All internal components slip out easily to convert into a 300-lb. storage unit. Comes complete with 1½” gate. Tank: 24 gauge, Type 304 SS, 18” dia. x 24” tall.

**M00407** 4-Frame Hand,  
Ship wt. 78 lbs. ea.\* ..... **\$473.30**

**M00408** 4-Frame Power,  
Ship wt. 2 pkgs. -  
78 lbs. and 15 lbs. ea.\* ..... **\$813.65**

\* See page 144



**HAND CRANK FOR  
HAND EXTRACTOR**

**M00407**



**NEW  
LEGS!**

**M00408**



**NEW  
REEL!**

**Stainless steel wire basket  
Shown with frames  
Frames not included**



# Dadant MANUFACTURED HONEY EXTRACTORS

## 6-frame Extractors

**6-Frame Extractors**—Designed for beekeepers using primarily 6¼" or shallow frames. Extract six 6¼" or shallow frames radially or 3 deep (9½") frames tangentially by using optional baskets (sold separately). Electric power features direct drive electric motor with manually operated electronic speed control. All welded 18" dia. 24" tall, 24 gauge, Type 304 stainless tank. 1½" plastic honey gate standard. For smooth operation of extractor see food approved grease on pages 88 and 94.

- ✘ **M00409** 6-Frame Extractor,  
Ship wt. 78 lbs. ea.\* .....\$584.80
- ✘ **M00410** 6-Frame Power Extractor,  
Ships 2 pkgs.- 78 lbs.\* and 15 lbs. ea. ....\$919.75  
\* See page 144
- ✘ **M00409B** Optional Baskets, for Deep Frames,  
Ship wt. 8 lbs. ....\$102.95



HAND CRANK FOR  
HAND EXTRACTOR

M00409



M00410



LASER CUT REEL  
included with  
either hand or  
electric power  
Ranger Extractors

**NEW  
REEL!**

**NEW  
LEGS!**

-- NO SUBSTITUTIONS OR PARTIAL RETURNS ON KITS --

1-888-922-1293

## Cappings Spinner

**Capping Spinners**—Great for the serious but smaller operations. Separate your honey and wax cappings with ease! The results are more honey to sell and dry, light fluffy wax cappings ready for melting into bricks. This machine is a must for beekeepers operating 100 hives or less. The 20 gauge stainless steel tank is 20" in diameter and 32" high. The bottom is die formed, and conical for ease of side draining. The removable cappings basket is constructed from 18 gauge perforated stainless steel and laser cut to perfection. Complete with legs, this machine ships at a weight of 150 lbs. in a heavy duty carton. **Ships Freight Only**

✘ **M00599** Junior Capping Spinner,  
Ship wt. 135 lbs. ea . . . . . **\$1,905.45**



## Combo Extracting Unit

An all-in-one extractor with uncapping tank. This unit is ideal for the hobby or sideline beekeeper. Unit features a 14"x18" uncapping area with basket underneath to hold cappings for honey drainage. A 6.5" x 18" area will hold your uncapped frames while waiting to be put inside the 6-frame Power Extractor. Honey storage compartment can hold up to 8 gallons of honey. For use with 6¼" or 5¾" frames. Baskets can be purchased to extract deep frames. Type 304, 16 gauge Stainless Steel with 1½" honey gate. **FOB Hamilton IL – Ships Freight Only. Call for rate.**

✘ **M00395** Combo Extracting Unit\* . . . . . **\$2,399.20**

✘ **M00409B** Optional Baskets, for Deep Frames,  
Ship wt. 8 lbs. . . . . **\$102.95**  
\* See page 144



M00395

**Save  
\$\$\$\$  
BUY a KIT**

# EXTRACTING KITS

## 2-frame Extractor Kit

**2-Frame Extractor Kit** — The 2-frame Extracting kit is the perfect extracting set up for the beginning beekeeper. The kit comes complete with 1 Junior Bench 2-frame extractor, 1 bottling bucket kit, 1 Speed King electric knife, plastic uncapping tub and 1 capping scratcher.

**✗ M00406KIT 2-Frame Extractor Kit . . . . . \$850.15**

**This ships in multiple packages.**

Ship wt. 125 lbs.

**\* See page 144**



## 4-frame Hand Extractor Kits

**Power style also available**

**4-Frame Extractor Kits** — A step up in size from the Junior Bench. The 4-frame extracting kit is perfect for the hobby beekeeper. It is available in both hand and power styles. This 4-frame extractor comes complete with extractor, 1 bottling bucket kit, 1 Speed King electric knife, plastic uncapping tub and 1 capping scratcher.

**✗ M00407KIT 4-Frame Hand Extractor Kit . . . . . \$891.10**

**This ships in multiple packages.**

Ship wt. 149 lbs.

**\* See page 144**

**✗ M00408KIT 4-Frame Power Extractor Kit . . \$1,064.95**

**This ships in multiple packages.**

Ship wt. 171 lbs.

**\* See page 144**



## 6-frame Extractor Kit

**Hand style also available**

**6-Frame Extractor Kits** — For those who prefer a radial extractor this is for you. The 6-frame extracting kit is available in both the power and hand styles. It is capable of extracting six 6 1/2" frames or shallow frames radially or three deep frames tangentially by using the optional baskets. The 6-frame radial extractor comes complete with extractor, 1 bottling bucket kit, 1 Speed King electric knife, plastic uncapping tub and 1 capping scratcher.

**\*Optional baskets for deep frames sold separately.\***

**✗ M00409KIT 6-Frame Hand Extractor Kit . . . . . \$919.00**

**This ships in multiple packages.**

Ship wt. 156 lbs.

**\* See page 144**

**✗ M00410KIT 6-Frame Power Extractor Kit . . \$1,241.25**

**This ships in multiple packages.**

Ship wt. 171 lbs.

**\* See page 144**

**✗ M00402 Optional Baskets, for Deep Frames, Ship wt. 8 lbs. ea. . . . . \$102.95**



# Dadant MANUFACTURED HONEY EXTRACTORS

## 6-12 Frame Radial Extractor with Motor

**6-12 Frame Radial Extractor** — No more hand reversing of frames—uncap, load, extract, and unload. Reel capacity 6 - 9 $\frac{3}{8}$ " deep frames; 12 - 6 $\frac{1}{4}$ " shallow frames. Frame guides provide positive frame placement. Ball bearings top and bottom. Powered by specifically designed direct drive motor with manually controlled electronic speed control. 120 v. operation. All welded 24" dia. 28" tall Type 304, 20 gauge stainless steel tank with inverted coned bottom and 1 $\frac{1}{2}$ " welded fitting. 1 $\frac{1}{2}$ " plastic honey gate w/barbed adapter included. (See diagram below for construction details). **Ships Freight Only**

✘ **M00412** 6-12 Frame Extractor Ship wt. 105 lbs.\* ..... \$1,617.85  
 \* See page 144

**ALL DADANT EXTRACTORS ARE MADE WITH GAUGES OF STEEL HEAVIER THAN OUR COMPETITORS!**

## CONSTRUCTION DETAILS

### 6- 12-Frame and 20-Frame Extractors

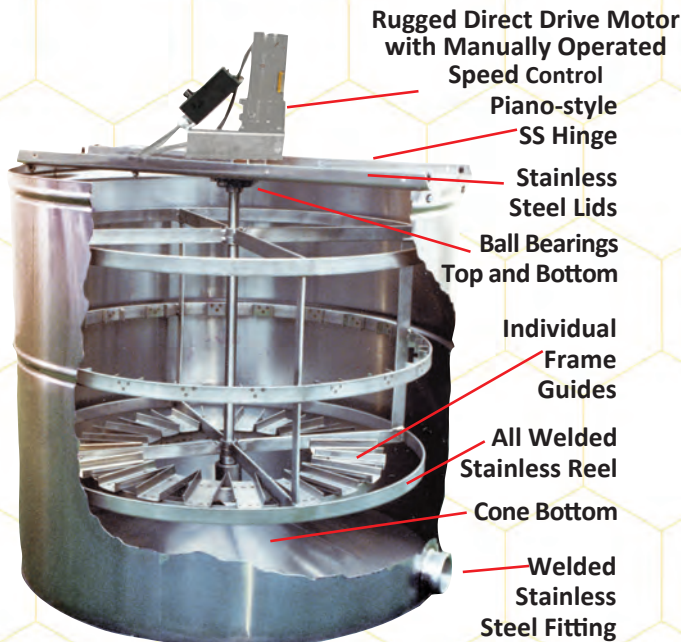

(20-Frame Extractor Shown)



The Concept of the Radial Extractor has saved more time and combs for beekeepers than any other invention. Radial extractors are the quickest, easiest, and most efficient way to extract honey from the comb. Frames are placed in the reel like spokes of a wheel. The reel spins, creating a centrifugal force and honey is thrown from both sides of the comb at once.

### 20-Frame Radial Extractor

- 4 Section Reel
- Type 304 Stainless Steel
- 20 Gauge Stainless Steel
- Holds Any Size Frame
- 20 Individual Frame Pockets
- 30" Diameter 28" High

The ideal choice for a growing extracting operation. From a few colonies to several hundred, the 20-frame radial is excellent. Comes complete with welded drain (2" Female Pipe Thread) with 2" to 1 $\frac{1}{2}$ " reducer bushing. A powerful variable speed direct drive motor powers the unit. It has a cone bottom and is 120 v. operation.

✘ **M00446** 20-Frame Radial,  
 Ship wt. 120 lbs.\* . \$2,005.10  
**Ships Freight Only**  
 \* See page 144



# Dadant MANUFACTURED HONEY EXTRACTORS



M00418

## 32-Frame Extractors

- 32-frame extractor
- 4 Section Reel
- Type 304 Stainless Steel
- 20 Gauge Stainless Steel
- Holds any size frame
- Can hold up to 60 frames

The 32-frame radial extractor by Dadant is ideal for the growing side line beekeeper. From twenty hives up to a few hundred the 32 frame radial extractor will do what you need. Powerful variable speed direct drive motor. Cone bottom and 120 V operation. This extractor comes with the automatic speed control just like the 60- and 84-frame extractors.

⊗ M00418 32-Frame Extractor ..... \$4,855.90



## Food Approved Grease



M009574

4 oz. Tube -  
Haynes Lubri-Film  
Ship wt. 4 ozs. ea.

M009574  
\$5.10

**Food Approved Lubricant** for extractors, honey house equipment and other applications where it is important to avoid contamination of food products with ordinary lubricants. On the hand extractors, use this to lubricate the crank handles. Also used on above hand and power units to lubricate the bottom bushing. Handy 12 oz. cartridge. Use **M009574** for 2-, 4-, and 6-frame extractors. Use **M0095712** for 12-frame and up extractors.



M0095712

12 oz. Cartridge -  
Haynes Lubri-Film  
Ship wt. 1 lb.

M0095712  
1-11, ea. .... \$11.30  
12+ ..... \$10.80

# MADE IN AMERICA BY US BUILT TO LAST FOR YOU

## 60-Frame Radial

- ½ Horsepower DC Motor
- 52" Tank Diameter
- Inverted Cone Bottom with 3" Male Center Drain
- 16 Ga. (.060) Stainless Steel Tank
- Segmented Reel Holds 60 Frames
- Smooth Reel Holds 85-90 Frames
- For smooth operation of extractor see food approved grease below.

✘ **M00450** Smooth Reel  
Ship wt. 800 lbs.\* . . . . . \$6,839.55

✘ **M00430** Segmented Reel  
Ship wt. 810 lbs.\* . . . . . \$6,941.60  
**Ships Freight Only \* See page 144**



**Heavy-Duty  
Try the Best**



## Honey Master 84-Frame

- ¾ Horsepower DC Motor
- 62" Tank Diameter
- Inverted Cone Bottom with 3" Male Center Drain
- 16 Ga. (.060) Stainless Steel Tank
- Segmented Reel Holds 84 Frames
- Smooth Reel Holds 96-120 Frames
- For smooth operation of extractor see food approved grease below.

✘ **M00452** Smooth Reel  
Ship wt. 1,000 lbs.\* . . . . \$7,570.45

✘ **M00432** Segmented Reel  
Ship wt. 1,010 lbs.\* . . . . \$7,678.60  
**Ships Freight Only \* See page 144**

## THE BIG RADIALS Speed Control



**Extractor Speed Control:** State-of-the-art for controlling up to 1 horsepower DC motors. Automatic or manual operation. On automatic, select your extracting time and let the control automatically advance the extractor speed. Easy to operate. Selector switch provides operation for all size extractors. 120 volt operation.

**M00443** Ship wt. 8 lbs. ea . . . \$1027.35

# STAINLESS STEEL TANKS AND ACCESSORIES



## Storage Tanks

**Stainless Steel Tanks**—Heavy duty, all welded. Type 304 food grade stainless steel. (Custom welded fittings or custom tanks on request. Larger tanks available.) \* See page 144

- ✘ **M00393 175 lb. Tank**, 24 Gauge SS\*  
 14 Gal. Flat Bottom, 14" dia., 23" ht.  
 1½" Nylon Gate Included  
 ..... \$248.70
- ✘ **M00490 300 lb. Tank**, 24 Gauge SS\*  
 25 Gal. Flat Bottom, 18" dia., 24" ht.  
 1½" Nylon Gate Included  
 ..... \$302.75
- ✘ **M00491 600 lb. Tank**, 20 Gauge SS  
 50 Gal. Flat Bottom, 24" dia., 28" ht.  
 1½" Stainless Welded Fitting  
 ..... \$501.75  
**Ships Freight Only**
- ✘ **M00492 1000 lb. Tank**, 20 Gauge SS  
 83 Gal. Cone Bottom, 30" dia., 28" ht.  
 2" Stainless Welded Outlet  
 ..... \$627.20  
**Ships Freight Only**
- ✘ **M00563 1920 lb. Tank**, 20 Gauge SS  
 145 Gal. Flat Bottom, 37" dia., 36" ht.  
 2" Stainless Welded Fitting Outlet  
 Reinforced Top Rim  
 ..... \$1,029.95  
**Ships Freight Only**
- ✘ **M00564 3600 lb. Tank**, 16 Gauge SS  
 285 Gal. Flat Bottom, 51" dia., 36" ht.  
 2" Stainless Welded Fitting Outlet  
 Reinforced Top Rim  
 ..... \$1,328.65  
**Ships Freight Only**

— Custom Tanks Fabricated —  
 Call Us For A Quote  
 1-217-852-3324



## Strainer Screens

Perforated aluminum screens in stainless frame that hooks over tank rim and nests inside tank. Used to support strainer cloth.

- ✘ **M00502 14" Screen** for 175 lb. Tank  
 Ship wt. 3 lbs. ea. .... \$63.75
- ✘ **M00495 18" Screen** for 300 lb. Tank  
 Ship wt. 4 lbs. ea. .... \$82.65
- ✘ **M00496 24" Screen** for 600 lb. Tank  
 Ship wt. 32 lbs. ea.\* ... \$92.65
- ✘ **M00497 30" Screen** for 1000 lb. Tank  
 Ship wt. 53 lbs. ea.\* ... \$102.95  
 \* See page 144



## Stainless Covers

Stainless steel covers are one piece spun stainless steel. Plastic handle. Fits tanks with strainer screen in place.

- ✘ **M00392 175 lb. Tank Cover**  
 Ship wt. 4 lbs. ea. .... \$60.00
- ✘ **M00534 300 lb. Tank Cover**  
 Ship wt. 5 lbs. ea. .... \$67.00
- ✘ **M00535 600 lb. Tank Cover**  
 Ship wt. 7 lbs. ea. .... \$83.80
- ✘ **M00536 1000 lb. Tank Cover**  
 Ship wt. 11 lbs. ea. .... \$120.05

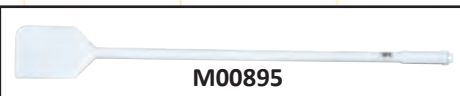

## 40 Inch Tank Scraper

Ease your tank cleaning. Specially shaped for cleaning all tank edges and surfaces. Durable white plastic. Ship wt. 3 lbs. ea.

M00895 Tank Scraper ..... \$40.80

HONEY GATES & VALVES  
 PAGE 100

## Pantry Tanks & Heater

### "Honey Pantry" Dispensing Tanks

**M00456 7½ Gallon Bottom Drain SS Tank** with 1½" welded outlet fitting. Type 304, 24 gauge Stainless. 14" dia. x 11½" tall with 4½" tall base. SS cover included.

- ✘ **M00456**  
 Ship wt. 27 lbs. ea.\* ... \$258.50  
 \* See page 144

**M00455 10½ Gallon SS Tank** with welded 1½ side wall drain. Type 304, 24 gauge stainless, 14" dia. x 16" tall. SS cover included.

- ✘ **M00455**  
 Ship wt. 27 lbs. ea.\* ... \$257.45  
 \* See page 144

- ✘ **M00459 Optional 125 Watt Heater** (not shown) 120 volt heater adheres to bottom of 7½ gallon tank only. Preset for approximately 100° F.  
 Ship wt. 1 lb. ea. .... \$164.75



M00456

M00455



# COMMERCIAL FILTERS AND PUMPS

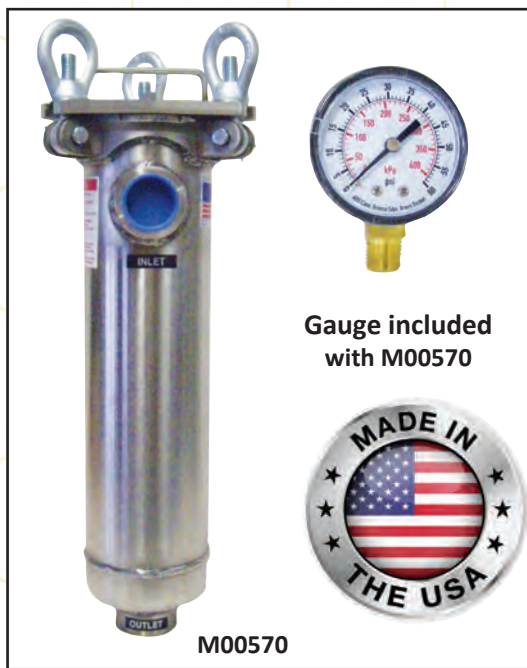

## Commercial Honey Filter

Dadant's Commercial Honey Filter is a stainless steel inline honey filter which can completely filter your honey, making it ready for sale at a premium price. The closure mechanism is safer and much easier to use than band clamps. The housings are manufactured with investment cast covers and collars. Strong 3-piece design offers easy access to perforated stainless steel basket and micron – rated filter bag. Filter is 6" in diameter and 15.5" long with 1½" inlet and outlet. Engineered for honey pump flow rates of up to 5 G.P.M. Honey temperature must be 100°F or higher for longer filter bag use. Change filter bags before pressure reaches 40 psi. Filter bags sold separately below.

✘ **M00570** Commercial Honey Filter  
Ship wt. 30 lbs. . . . . \$729.30

*It is recommended that an air vent valve (not included) be installed when plumbing the filter.*



## Filter Bag

**M00561** Replacement Bag Only,  
Ship wt. 2 ozs. ea. . . . . \$6.55  
(for use with the Commercial Honey Filter M00570)



## 1½ Inch Honey Pump - Stainless Steel

Stainless steel, rugged, heavy-duty special 1½" gear pump with built-in pressure relief valve designed for pumping liquids like honey. 1 hp 120/240 volt motor. 2 variable-speed pulleys and slotted mounts for easy adjustments allow speed ranges from 500-880 rpm. Pumps approximately 3-6 GPM of honey. Belt guards included. Complete instructions. **Ships Freight Only**

✘ **M00539S** Honey Pump, Ship wt. 146 lbs. ea.\* . . . . \$2,141.30  
\* See page 144

**BOTH PUMPS ARE NOT AVAILABLE AT ALL BRANCH LOCATIONS**

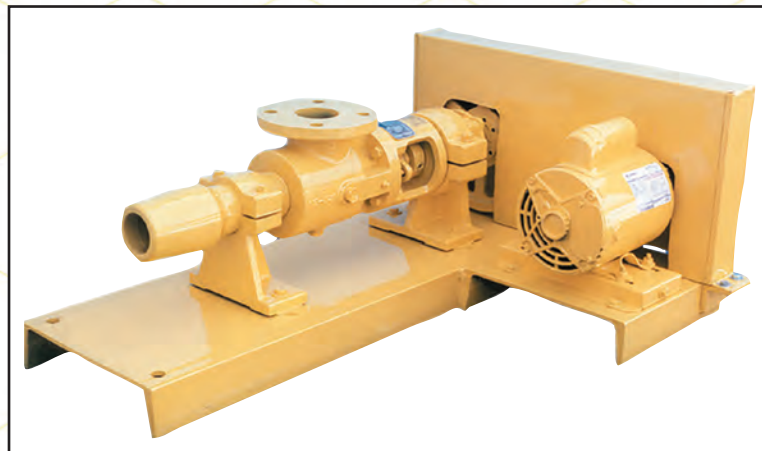

## Progressive Cavity Pump Pumps Honey with Cappings

Excellent quality pump that allows solids to pass through the pump with liquids. 2½" inlet, 2" outlet. At 500 rpm, 9 gallons/minute output. Complete pumping unit comes with 2 hp electric motor, 120 or 240 volt, belt, pulleys and guard. **Ships Freight Only F.O.B. IL Only**

✘ **M00545** Pump Complete\* . . . . . \$4,871.85

\* See page 144

✘ **M00546** Pump Only . . . . . CALL

**A POPULOUS COLONY MAY CONTAIN 40,000 TO 60,000 BEES DURING THE LATE SPRING OR EARLY SUMMER.**

**THE QUEEN BEE LIVES FOR ABOUT 2-3 YEARS. SHE IS THE BUSIEST IN THE SUMMER MONTHS, WHEN THE HIVE NEEDS TO BE AT ITS MAXIMUM STRENGTH, AND LAYS UP TO 2,500 EGGS A DAY.**

# HONEY GATES AND HONEY VALVES



M00579

## 1 1/2" Plastic Gate

**Designed Specifically by *Dadant & Sons* for Use With Honey Injection Molded High Strength**

Scissors action for clean cutoff against an O-ring. Adjustable gate tension. 1 1/2" pipe thread for threading into a fitting or use 1 1/2" plastic nut (provided) to install gate directly into hole in tank side. Comes with a versatile plastic barbed adapter for 1 1/2" tubing hookups. Excellent quality. Ship wt. 1 lb. ea.

**M00579 1 1/2" Plastic Gate . . . . . \$15.40**

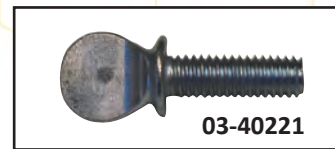

03-40221

## Replacement Thumb Screw for 1 1/2" Plastic Gate

For the M00579 plastic gate. Ship wt. 1 oz. ea.

**03-40221 Metal Replacement Thumb Screw . . . . . \$ .93**



M00457

## Dispensing Valve

**M00457 3/4" Dispensing Valve for "thin" liquids, will fit 7 1/2 gallon and 10 1/2 gallon Pantry Tanks. Ship wt. 2 lbs. ea.**

**M00457 Dispensing Valve . . . . . \$36.00**

Can use with (7 1/2 gal. & 10 1/2 gal. Tank) for "thick" liquids or use the following:

M005855 SS Bottling Valve or M00585 1" Brass Filler

Adapter Kit M005854 is required to fit either valves above.

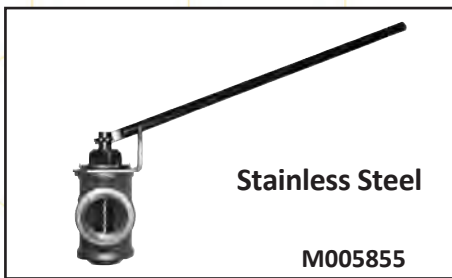

Stainless Steel

M005855

## Honey Bottling Valve — 1 Inch

A solid, stainless steel, self closing no-drip valve, 1" threads. Rising plunger valve. Spring close. Can use M005854 adapter kit for use with 7 1/2 and 10 1/2 honey pantry tanks.

**M005855 Honey Bottling Valve, Ship wt. 3 lbs. ea. . . . . \$154.45**

**M00585, M005855 will fit tanks with 1" male thread outlet directly with no adapters. Valves can be used with other size outlets, but will require adapters.**

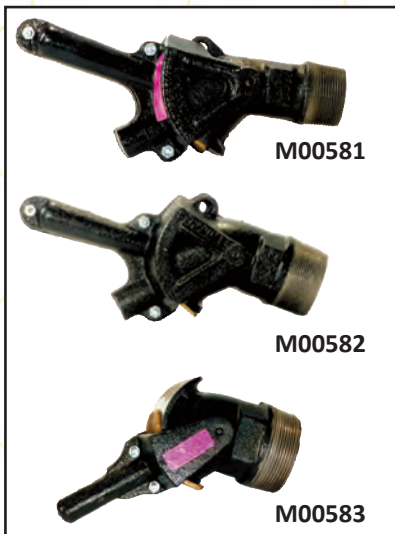

M00581

M00582

M00583

## Perfection Gates

**Perfection Gates** are cast iron construction with brass inserted seats, male pipe threads. Used on steel drums but not recommended for use on regular stainless steel honey storage or extractor tanks. Perfection gates will fit steel drums, 16 gauge or heavier metal storage tanks.

**M00581 1 1/2" Perfection Gate, Ship wt. 4 lbs. ea. . . . . \$99.85**

**M00582 2" Perfection Gate, Ship wt. 5 lbs. ea. . . . . \$102.95**

**M00583 3" Perfection Gate, Ship wt. 7 lbs. ea. . . . . \$164.75**



M005854



Offset Handle for Easy Filling

M00585

## 1" Brass Bottle Filler

**Brass Bottle Fillers** are ball valves that have been machined on one end to obtain good cutoff. Both on and off lever action. Comes complete with 90° bend. 1" has female pipe threads. Stainless steel movable ball seals against nylon seats to insure very smooth action and long wear. Ship wt. 2 lbs.

**M00585 1" Brass Bottle Filler . . . . . \$113.25**

## Adapter Kit

**M005854 Adapter Kit** for Honey Bottling Valve-M005855. To fit M00455, 10 1/2 gallon Dispensing Tank, available on page 98. M005854 adapter kit will also work with M00456 7 1/2 gallon honey pantry tank. Ship wt. 3 lbs. ea.

**M005854 Adapter Kit. . . . . \$20.35**

# HONEY HARVESTING

## Pump Control-Strainer

15 Gallon—12" x 12" x 32"

Collect honey directly from your extractor, strain out most foreign material, and control your honey pump in one operation. Single tank unit is all MIG welded stainless steel. Comes complete with wired float switch and strainer screens. Comes with Type 304, 20 gauge, stainless steel 1½" female pipe thread welded inlet and outlet fittings. Ship wt. 59 lbs. ea.\*

**Ships Freight Only.**

**M00558** Pump Control Strainer  
 ..... \$617.95  
 \* See page 144

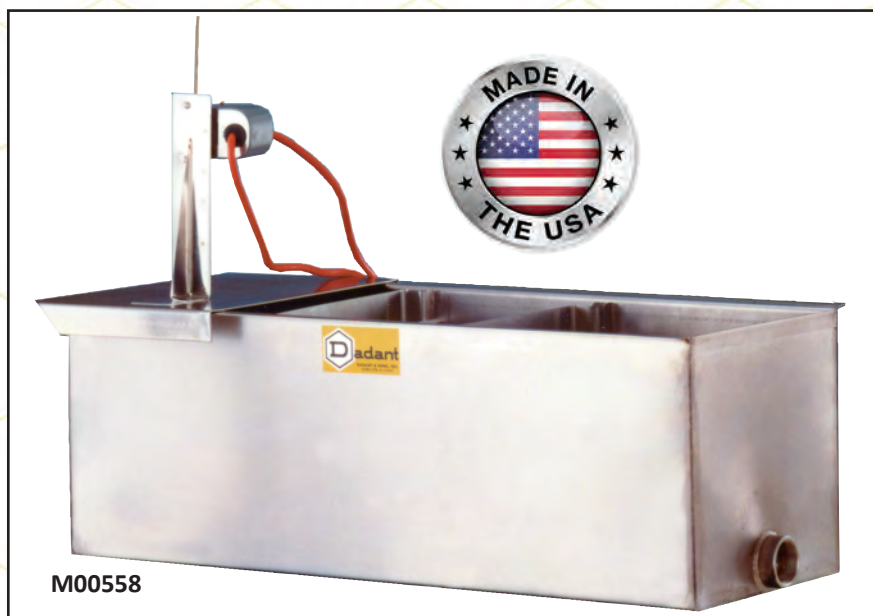

## 20 Gallon Water Jacketed Clarifier

Double-wall all MIG welded Type 304, 20 gauge, stainless steel construction provides a water jacket around the honey compartment. Two double baffles trap heavy and floating material. Welded tank fittings. 1½" male pipe thread inlet and 1" pipe outlet. Complete with wired float switch, 1700 watt 120 volt heater, baffling system, and two-piece complete cover.

36¼" L x 14¼" W x 14¼" H. Ship wt. 66 lbs. ea.\*

**Ships Freight Only.**

**M00550** 20 Gal. Clarifier  
 ..... \$1,359.55  
 \* See page 144

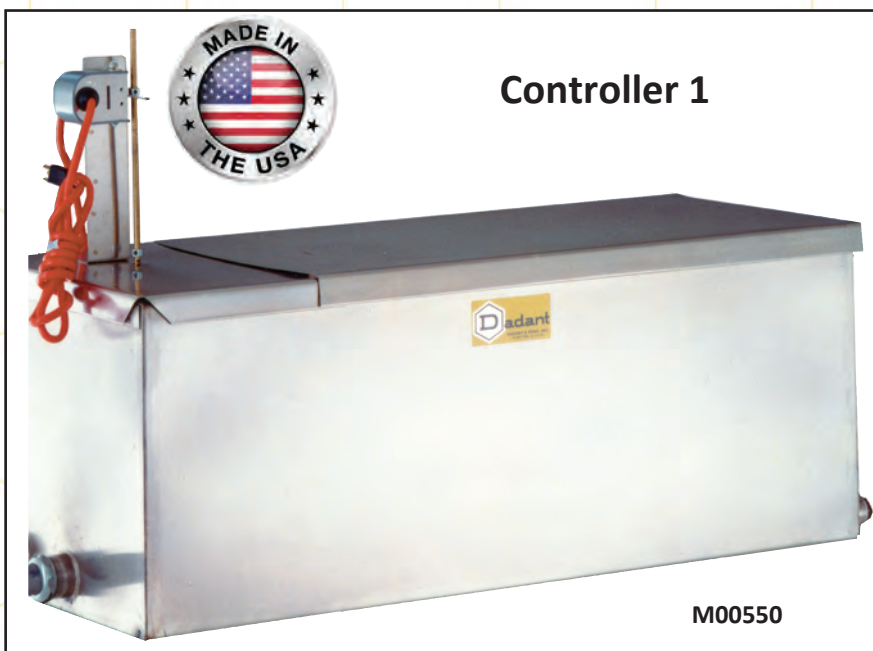

## Flash Heater

The "HEART" of a honey packing system. Heats honey rapidly in a closed system to preserve flavor. Honey is pumped through copper coils submerged in hot water. Capacity for 100°F temperature rise in up to 1800 lbs. of honey per hour. Controllable for precise heating. 36" x 36" x 14" deep, 16 gauge, type 304, all-welded stainless steel tank. 4 - 2" female pipe thread openings provided. Includes a 0-200°F thermometer. Comes with stainless steel cover. Heaters sold separately (see page 83). Ship wt. 245 lbs. ea.\*

**Ships Freight Only.**

**M00569** Flash Heater ..... \$3,030.80  
 \* See page 144

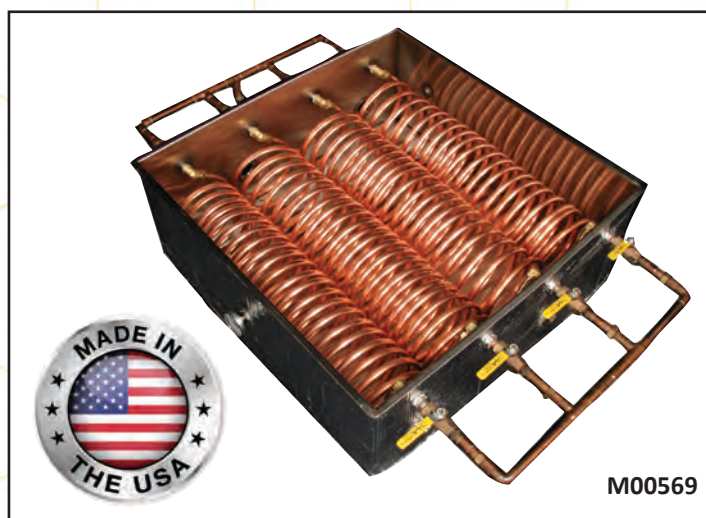

# HONEY HARVESTING

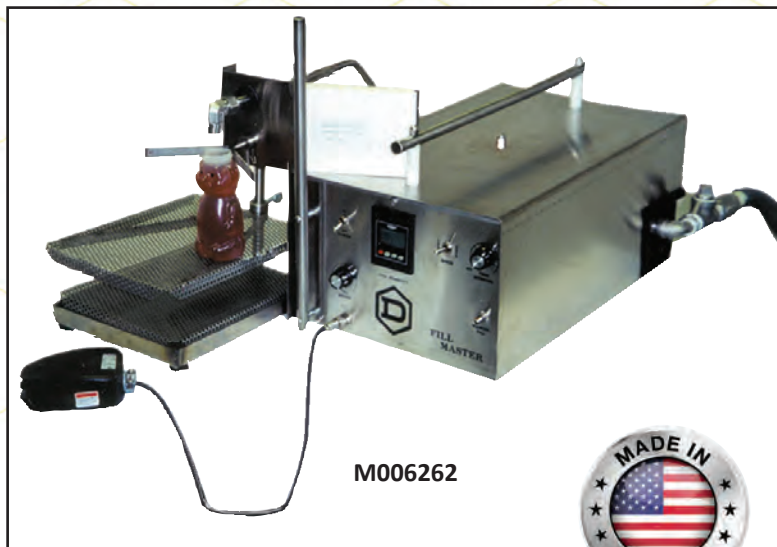

M006262



**Portable Table Top Unit—Self Priming—  
All Electric (120 volt) Pack From Any Bulk Container—  
Easy To Adjust Fill Quantity**

## Fill Master

**Power Bottle Filler Excellent**

**No Drip Accurate**

**Dadant Designed — Dadant Mfg.**

The Fill Master was revised last year with a higher torque motor. This allows the unit to fill bottles with 75° F honey (may see fill volume variations and colder temperatures). But accuracy of filling volume is more accurate from 100-110° F. The gear pump also works very well for creamed honey making a very smooth texture. The Fillmaster has been used by our customers to fill containers with gear oil, dressings, maple syrup and beer/wine along with other viscous products.

The Fill Master is Dadant's answer to many requests for a simple, no drip, easily adjusting, inexpensive, accurate bottle filling machine. As with any bottle filler, the unit works best with warm (110°F) honey. No special bottling tank is required as it is self-priming. You may pack from 60# buckets, storage tanks or anything that holds honey. Adjust fill level from ounces to gallons in seconds. No fill limitations. No air supply needed. A great unit at a low price.

The Stainless Steel Fill Master is made out of Type 304, 20 gauge, stainless steel. Free video—just give us a call. Branch pickup is available. Ship wt. 85 lbs.\*

**Ships Freight Only.**

✘ M006262 Fill Master . . . . . \$4,701.95 \* See page 144

## Dadant Honey Dryer . . . and so much more



M00568



### FREE BROCHURE Includes:

Pictures—Flow Diagram—Instructions  
Phone or Write Your Nearest Dadant Branch

- Removes Moisture — 1½ to 2 points of moisture removed from up to 2 barrels of honey per hour
- Slows Crystallization — "Shelf Life"—The length of time honey is on the shelf before crystallization occurs can be greatly increased by properly controlled heating. The M00569 Flash Heater is part of the Honey Dryer.
- Inexpensive To Operate
- Fully Controllable
- Low-temperature Processing
- Not Affected By Atmospheric Conditions
- Clarifies Honey — Beautiful honey comes out even when cloudy honey (due to suspended air and fine wax particles) goes in.
- Removes Fermentation — Discovered by accident, but it has worked every time. The first test pumped 19.5% moisture, fermented honey in, and 18% "good" honey came out.

✘ M00568 Dadant Honey Dryer,  
Ship wt. 1000 lbs.\* . . . . \$21,408.90  
\* See page 144

**Ships Freight Only.**

**Not available at all branches**

# MULTI PURPOSE — WATER JACKETED TANKS

## Water Jacketed Tanks

### 10 Gallon Capacity

Comes with 14" stainless steel removable lid. All fittings welded, 1" male pipe thread outlet. No outlet valve supplied. Order your choice from page 100, depending on your application. 14" diameter fill area. 18" diameter x 21" height. 1700 watt, 120 volt immersion heater. Both inner and outer tank are 20 gauge, type 304 stainless steel construction.

**Ships Freight Only.**

- ✘ **M00624** 10 Gallon,  
Ship wt. 78 lbs. ea. \* . . . . . \$1,047.95  
\* See page 144



M00624

**Prevents scorching,  
hot spots or overheating**

## Water Jacketed Tanks

### 25 Gallon Capacity

***Eases product handling and prevents damage***

- Double-Walled Tank
- Thermometer to Measure Water Temperature
- All Welded Tanks and Fittings
- Bottom Drain
- Type 304 Stainless Steel
- Water Sight Glass
- Immersion Heater Included

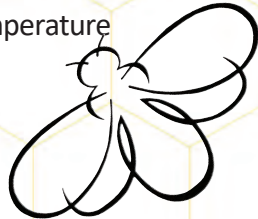

M00616

Comes with 18" removable Lexan clear cover. Large filling area. All fittings welded. 1" male pipe thread outlet. No outlet valve supplied. Order your choice from pages 98 & 102. 21" diameter x 31" height. 1700 watt, 120 volt immersion heater included. Both inner and outer tanks are 20 gauge, type 304 stainless steel construction.

**Ships Freight Only.**

- ✘ **M00616** 25 Gallon, Ship wt. 125 lbs.\* **\$1,302.90**
- ✘ **M00617** Optional Stirring System  
Ship wt. 59 lbs. . . . . \$793.05
- ✘ **M00619** Optional 24" Thermometer,  
*Use Only With Stirring System*  
Ship wt. 3 lbs. . . . . \$130.25

\* See page 144

Many products require indirect heating to prevent scorching, hot spots or overheating, and to assist bottling, processing or material handling. This tank works like a "double-boiler" and is basically a smaller tank inside a larger tank. The space between the tanks is filled with water and an immersion heater is immersed in the water. In turn, the heated water warms the product that has been placed in the inner tank. This indirect heating is a gentler method of warming and has been found necessary to ease product handling and prevent damage to products such as honey, waxes, soaps, syrups, etc.

# MULTI PURPOSE — WATER JACKETED TANKS



**70 gallon  
M00628**

- Double-Walled Tank
- Bottom Drain
- All Welded Tanks and Fittings
- Type 304 Stainless Steel
- Water Sight Glass
- Immersion Heater Included
- Thermometer to Measure Water Temperature



Many products require indirect heating to prevent scorching, hot spots or overheating, and to assist bottling, processing or material handling. This tank works like a “double-boiler” and is basically a smaller tank inside a larger tank. The space between the tanks is filled with water and an immersion heater is immersed in the water. In turn, the heated water warms the product that has been placed in the inner tank. This indirect heating is a gentler method of warming and has been found necessary to ease product handling and prevent damage to products such as honey, waxes, soaps, syrups, etc.

## 70 Gallon Capacity

Comes with 30” Lexan clear removable cover. Large filling area. All fittings welded. 1” male pipe thread outlet. No outlet valve supplied, order your choice from this page or page 98. 33” diameter x 32” height. 4500 watt, 240 volt immersion heater included. Both inner and outer tanks are 16 gauge, type 304 stainless steel construction. **Ships Freight Only.**

- ✘ **M00628** 70 Gallon, Ship wt. 175 lbs.\* ... **\$2,379.25**
- ✘ **M00629** Optional Stirring System  
Ship wt. 59 lbs.....**\$861.05**
- ✘ **M00619** Optional 24” Thermometer,  
*Use Only With Stirring System,*  
Ship wt. 3 lbs.....**\$118.40**



**130 gallon  
M00632**



## 130 Gallon Capacity

- ✘ **M00632** 130 Gallon\* ..... **\$6,061.50**  
**Call for availability** \* See page 144



## 40 Inch Tank Scraper

Ease your tank cleaning. Specially shaped for cleaning all tank edges and surfaces. Durable white plastic.

- M00895** Tank Scraper,  
Ship wt. 3 lbs. ea. .... **\$40.80**

# OUTLET VALVES



**M00585**

**Brass Bottle Fillers** are ball valves that have been machined on one end to obtain good cutoff. Both on and off lever action. Comes complete with 90° bend. 1” has female pipe threads. Stainless steel movable ball seals against nylon seats to insure very smooth action and long wear.

- M00585** 1” Brass Filler,  
Ship wt. 2 lbs. .... **\$113.25**



**M006142**

The heated valve keeps liquid wax in valve area. No down time waiting for wax to liquify. Constant 185°-190°F.

*Not recommended for use with honey.*

- M006142**  
Heated 1” Valve,  
Ship wt. 3 lbs.  
**\$271.85**

# GLASS HONEY CONTAINERS

All weights listed for containers are honey weights. Other liquids may vary in weight. For example, a 12 oz. container will hold 12 ozs. of honey, but only 8 ozs. of water.

**GLASS SHIPMENTS CANNOT BE INSURED. All glass shipped will be at customer's risk.**



## 3 lb. & 5 lb. Glass Jar with Lid

Each jar makes a great container for honey and some use them exclusively for their payments to the landowner of the property the beekeepers hives are sitting on. It is also known as a yard rent jar. Both take a standard G70 closure. Lid included.

✗ **M001932** 3 lb. Glass Round Quart Jar, Plastic G70 Lid, 1-99 ctns. . . . . **\$18.50**  
Ctn/12, Ship wt. 12 lbs.

✗ **M001922** 5 lb. Glass Round Jar, Plastic G70 Lid, 1-99 ctns. . . . . **\$22.55**  
Ctn/6, Ship wt. 15 lbs.



## \*Queenline Glass Honey Jars

### Queenline Honey Jars with Plastic Lids

| Jar Size | No. of Jars Per Ctn. | Lid Size | Item Number      | Ship wt. Per Ctn. lbs. | Price Per Ctn. 1-99 Cartons |
|----------|----------------------|----------|------------------|------------------------|-----------------------------|
| 8 oz.    | 24                   | 48mm     | ✗ <b>M001952</b> | 10                     | <b>\$21.35</b>              |
| 1 lb.    | 24                   | 58mm     | ✗ <b>M001972</b> | 14                     | <b>\$25.05</b>              |
| 2 lb.    | 12                   | 63mm     | ✗ <b>M001982</b> | 12                     | <b>\$19.00</b>              |
| 4 lb.    | 6                    | G70      | ✗ <b>M001992</b> | 10                     | <b>\$18.65</b>              |

Queenline Jars with no lids are available. Call for pricing!

**Replacement lids available on page 107.**

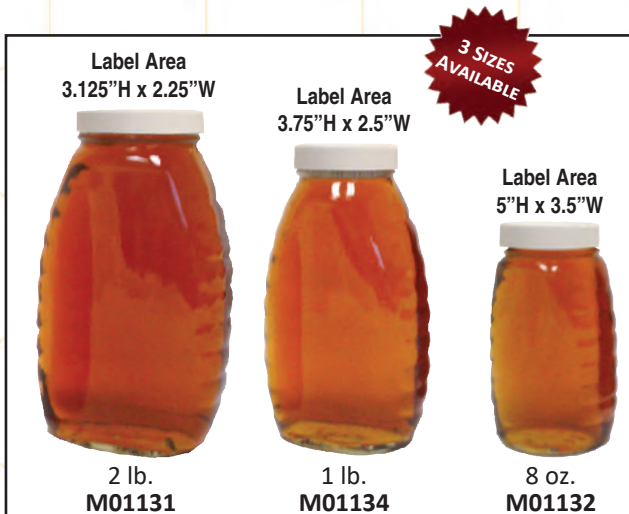

## Classic Glass

### Classic Glass Honey Jars with Lids

| Jar Size | No. of Jars Per Ctn. | Lid Size | Item Number     | Ship wt. Per Ctn. lbs. | Price Per Ctn. 1-99 Cartons |
|----------|----------------------|----------|-----------------|------------------------|-----------------------------|
| 8 oz.    | 24                   | 48 mm    | ✗ <b>M01132</b> | 11                     | <b>\$18.10</b>              |
| 1 lb.    | 24                   | 48 mm    | ✗ <b>M01134</b> | 15                     | <b>\$19.00</b>              |
| 2 lb.    | 12                   | 63 mm    | ✗ <b>M01131</b> | 12                     | <b>\$15.30</b>              |

Classic Glass with no lids are available. Call for pricing!

**Please call for discounted pricing on quantities over 100!**

All containers priced FOB Hamilton, IL—for local prices call your nearest Dadant branch

# GLASS HONEY CONTAINERS

## Muth Jars

### *A Touch of the Late 1800's*

Muth jars decorated with a skep scene and the words "Pure Honey" are a great addition to any honey container collection. **Newly available in an 8 oz. container.** Cork stopper included.

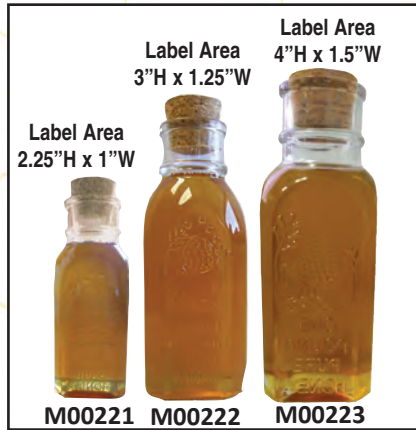

**Shrink Bands for Muth Jars**  
**M00827** – c/100 shrink bands  
 For 4 oz. Ship wt. 2 ozs. . . . . **\$9.85**  
**M00828** – c/100 shrink bands  
 For 8 oz. Ship wt. 2 ozs. . . . . **\$9.85**  
**M00287** – c/250 shrink bands  
 For 16 oz. Ship wt. 3 ozs. . . . . **\$7.60**

## 12 oz. Cylinder Jars w/Lids

This 12 oz cylinder hex jar will showcase your prized honey and make it sparkle. With a wide mouth filling this jar couldn't be any easier. Available in C/12.

**M011481** C/12 3 oz., Ship wt. 8 lbs. . . . **\$17.45**

**Honey not included**

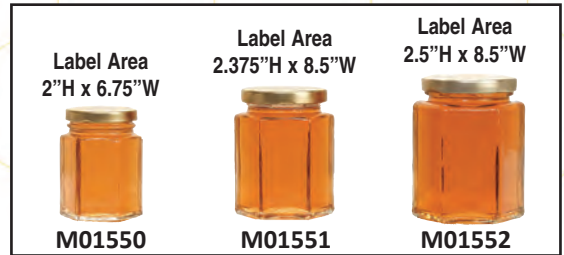

## Hex Jars

Beautifully designed hex jars are great containers for display and are exquisite when decorated creatively. Available in 3 sizes, 5.5 oz., 9.5 oz. and 13.5 oz. Containers come with gold twist-off plastisol lids.

### Hex Jar - Carton of 12

**M01550** 5.5 ozs., Ship wt. 5 lbs. . . . . **\$12.80**  
**M01551** 9.5 ozs., Ship wt. 8 lbs. . . . . **\$16.95**  
**M01552** 13.5 ozs., Ship wt. 9 lbs. . . . . **\$17.90**



## 3 oz. and 12 oz. Glass Skeps w/Lids

These beautiful skep jars will make the perfect honey container for yourself or as a gift to others. Hold 3oz or 12 oz of honey weight by volume. 3 oz available in c/24. 12 oz available in c/12.

**M011451** C/24 3 oz., Ship wt. 5.5 lbs. . . . **\$17.45**  
**M011491** C/12 12 oz., Ship wt. 8 lbs. . . . **\$16.35**



# PLASTIC HONEY CONTAINERS

## PET Oval

**M00208** 1 lb. PET Plastic Honey Oval Plastic 58mm Lid  
 Carton of 12, Ship wt. 3 lbs. 1-99 ctns. . . . . **\$13.50**

**M00209** 2 lb. PET Plastic Honey Oval Plastic 63mm Lid  
 Carton of 12, Ship wt. 3 lbs 1-99 ctns. . . . . **\$18.40**

## Plastic Honey Bee Containers

| Item Number & Description                            | Lid Style        | Quantity                  | Price          | Ship wt. |
|--|------------------|---------------------------|----------------|----------|
| <b>M002042</b><br>1 lb. Plastic Honey Bee Container  | Plastic 43mm Lid | Carton of 24<br>1-99 ctns | <b>\$16.15</b> | 3 lbs.   |
| <b>M002052</b><br>2½ lb. Plastic Honey Bee Container | Plastic 58mm Lid | Carton of 6<br>1-99 ctns. | <b>\$8.50</b>  | 3 lbs.   |

**Please call for discounted pricing on quantities over 100!**

All containers priced FOB Hamilton, IL—for local prices call your nearest Dadant branch



# PLASTIC HONEY CONTAINERS

All weights listed for containers are honey weights. Other liquids may vary in weight. For example, a 12 oz. container will hold 12 ozs. of honey, but only 8 ozs. of water.



## Inverted Plastic Jar with Hexagon Pattern

*Inverted Plastic Honey Jar  
with 38mm Drip-Proof Snap Cap Lids*

| Jar Size | No. of Jars Per Ctn. | Item Number | Ship wt. Per Ctn. lbs. | Price Per Ctn. 1-99 Cartons |
|----------|----------------------|-------------|------------------------|-----------------------------|
| 1 lb.    | 24                   | M01158      | 3                      | \$22.55                     |

## Classic Plastic

*Classic Plastic Honey Jars  
with 38mm Snap Caps*

| Jar Size | No. of Jars Per Ctn. | Item Number | Ship wt. Per Ctn. lbs. | Price Per Ctn. 1-99 Cartons |
|----------|----------------------|-------------|------------------------|-----------------------------|
| 8 oz.    | 24                   | M01150      | 2                      | \$19.00                     |
| 1 lb.    | 24                   | M01151      | 3                      | \$23.75                     |
| 1½ lb.   | 24                   | M01152      | 4                      | \$27.30                     |
| 2 lb.    | 12                   | M01153      | 2                      | \$16.65                     |

*Please specify red or yellow snap caps.  
If none specified yellow will be sent.*

**Classic Plastic with no lids are available.  
Call for pricing!**

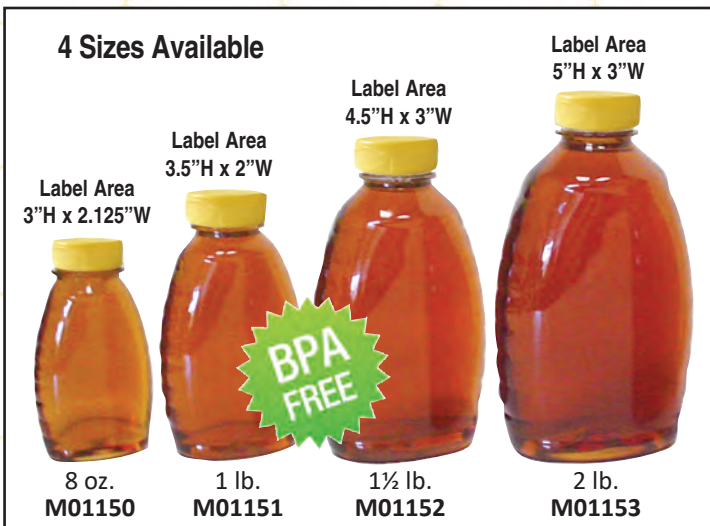

Old Dadant truck loading beehives

## 3 Pound Plastic Jar with Hexagon Pattern

*Plastic Honey Jar with 38mm Snap Caps*

| Jar Size | No. of Jars Per Ctn. | Item Number | Ship wt. Per Ctn. lbs. | Price Per Ctn. 1-99 Cartons |
|----------|----------------------|-------------|------------------------|-----------------------------|
| 3 lb.    | 6                    | M01159      | 3                      | \$10.65                     |

Replacement lids available on page 107.



Shipments of multiple case quantities may be repackaged and shipping weights may be converted to dimensional weight. All containers priced FOB Hamilton, IL—for local prices call your nearest Dadant branch

All weights listed for containers are honey weights. Other liquids may vary in weight.  
For example, a 12 oz. container will hold 12 ozs. of honey, but only 8 ozs. of water.

## HONEY BEAR DISPENSERS

### 2 oz. Clear Bear with caps c/50

This clear panel bear holds approximately 2 oz. of honey.  
Great for gifts or selling samples of your honey.

M00258 Ship wt. 3 lbs. . . . . \$32.10



(A) 12 oz. Opaque Bear



(B) 2 lb. Opaque Bear



(C) 8 oz. Clear Bear



(D) 12 oz. Clear Bear



(E) 1 1/2 lb. Clear Bear

IT TAKES ABOUT  
556 WORKERS TO  
GATHER 1 POUND  
OF HONEY FROM  
ABOUT 2 MILLION  
FLOWERS.



|  | A                                  | B                                  | C                                  | D                                  | E   |
|--|------------------------------------|------------------------------------|------------------------------------|------------------------------------|---|
| <b>Carton of 12 Complete with Caps &amp; Collars</b> | M00255<br>Carton of 12             | M00277<br>Carton of 12             | M00245CPN<br>Carton of 12          | M00255CPN<br>Carton of 12          | No Collars<br>M00271CPN<br>Carton of 12         |
|  | \$11.85<br>Ship wt. 3 lbs.         | \$17.75<br>Ship wt. 3 lbs.         | \$11.85<br>Ship wt. 3 lbs.         | \$11.85<br>Ship wt. 3 lbs.         | \$11.85<br>Ship wt. 3 lbs.                      |
| <b>Bulk Pack with Caps &amp; Collars</b>             | <del>M00256</del><br>250/Case      | <del>M00278</del><br>100/Case      | <del>M00246CPN</del><br>396/Case   | <del>M00256CPN</del><br>250/Case   | No Collars<br><del>M002713CPN</del><br>138/Case |
| 1-4 cases  | \$115.35                           | \$123.65                           | \$222.45                           | \$137.95                           | \$103.40  |
| 5+ cases   | \$112.95                           | \$112.95                           | \$214.10                           | \$130.80                           | \$95.00   |
| Ship wt. per case                                    | Ship wt. 52 lbs.<br>* See page 144 | Ship wt. 59 lbs.<br>* See page 144 | Ship wt. 52 lbs.<br>* See page 144 | Ship wt. 52 lbs.<br>* See page 144 | Ship wt. 50 lbs.<br>* See page 144              |
| <b>Bulk Pack without Caps &amp; Collars</b>          | <del>M002561</del><br>250/Case     | <del>M002762</del><br>100/Case     | <del>M002461CPN</del><br>396/Case  | <del>M002561CPN</del><br>250/Case  | <del>M002712CPN</del><br>138/Case               |
| 1-3 cases  | \$74.90                            | \$110.55                           | \$162.75                           | \$95.15                            | \$75.10   |
| 4-19 cases   | \$71.85                            | \$104.70                           | \$160.35                           | \$91.00                            | \$70.30   |
| 20-39 cases  | \$70.65                            | \$102.35                           | \$158.00                           | \$89.80                            | \$68.00   |
| 40-79 cases  | \$68.95                            |                                    | \$155.65                           | \$88.65                            |   |
| 80+ cases  | \$64.15                            |                                    | \$153.20                           | \$87.45                            |   |
| Ship wt. per case                                    | Ship wt. 52 lbs.<br>* See page 144 | Ship wt. 59 lbs.<br>* See page 144 | Ship wt. 52 lbs.<br>* See page 144 | Ship wt. 52 lbs.<br>* See page 144 | Ship wt. 50 lbs.<br>* See page 144              |

All bear lids are 38mm whether it's snap cap or spout. Caps & Collars available separately on page 107.  
Shipments of multiple case quantities may be repackaged and shipping weights may be converted to dimensional weight.  
All containers priced FOB Hamilton, IL—for local prices call your nearest Dadant branch

# HONEY CONTAINERS AND ACCESSORIES



Label Area  
1"H x 1.75"W

M00245

## 8 oz. Bear opaque

M00245 Carton of 12, Ship wt. 3 lbs  
Complete w/caps & collars. . . \$11.20

### Bulk Pack with Caps & Collars

✗ M00246 400/Case . . . . \$279.60  
1-4 cases wt. per case  
Ship wt. per case 59 lbs.\*

### Bulk Pack without Caps & Collars

✗ M002461 400/Case . . . . \$220.00  
Ship wt. 59 lbs.\* \* See page 144



M00787

## Spout Cap (38 mm) — Fits 8 oz., 12 oz., 1½ lb. & 2 lb. Bears

M00787 Spout Cap,  
Ship wt. 1 oz. ea. . . . . \$0.16

✗ M007871 Carton of 1250,  
Ship wt. 18 lbs. ea.  
1-3 . . . . . \$191.55 per Carton  
4-7 . . . . . \$187.95 per Carton  
8-15 . . . . . \$184.40 per Carton  
16+ . . . . . \$180.80 per Carton

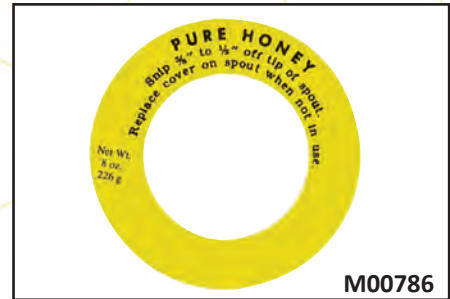

M00786

## Collars for Squeeze Bears

Price per 1000, Ship wt. 7 lbs.

M00786 . . . . . Collar for 8 oz. Bear  
M00788 . . . . . Collar for 12 oz. Bear  
M00792 . . . . . Collar for 2 lb. Bear  
1-4 Cartons . . . . . \$42.80 per 1000  
5-9 Cartons . . . . . \$40.40 per 1000  
10-19 Cartons . . . . . \$39.20 per 1000  
20+ Cartons . . . . . \$38.00 per 1000

## Snap Caps & Seals

### for 38mm Containers with Tamper Resistant Seals

Snap Lock Caps have given 38mm lid containers a new look. Easy clean dispensing. Yellow or red, 1-piece snap cap with hinge and a built-in dispensing nozzle. Fits all plastic squeeze dispensers. Comes with tamper resistant seal.

M00844 Ship wt. 1 oz. each  
1-1699 . . . . . \$ .16 ea.  
1700+ . . . . . \$ .14 ea.

M00844R Ship wt. 1 oz. each  
1-1699 . . . . . \$ .16 ea.  
1700+ . . . . . \$ .14 ea.



## 1 lb. Skep

M00273 1 lb. Skep with Snap Caps  
Carton of 12, Ship wt. 3 lbs. . . . . \$13.05

### Bulk Pack with Snap Caps

✗ M002744 250/Case  
1-4 cases . . . . . \$139.15  
5+ cases . . . . . \$129.65  
Ship wt. per case 90 lbs.

### Bulk Pack without Snap Caps

✗ M002745 250/Case  
1-3 cases . . . . . \$103.45  
4-19 cases . . . . . \$99.65  
20+ cases . . . . . \$97.15  
Ship wt. per case 90 lbs.



M00273

## Lids Only — Plastic

| Size    | 43 mm          | 48 mm          | 58 mm          | 63 mm          | 89 mm          | G70            |
|---------|----------------|----------------|----------------|----------------|----------------|----------------|
|         | ✗ M006411      | ✗ M01053       | ✗ M01035       | ✗ M01036       | ✗ M01033       | ✗ M01037       |
| Plastic | 100 .18 ea.    | 100 .14 ea.    | 100 .19 ea.    | 100 .19 ea.    | 100 .27 ea.    | 100 .21 ea.    |
|         | 1,000 .15 ea.  | 1,000 .14 ea.  | 1,000 .18 ea.  | 1,000 .19 ea.  | 1,000 .26 ea.  | 1,000 .20 ea.  |
|         | 20,000 .14 ea. | 20,000 .12 ea. | 20,000 .17 ea. | 20,000 .18 ea. | 20,000 .21 ea. | 20,000 .19 ea. |

### Minimum Quantity (100 ea. per size & style)

Shipments of multiple case quantities may be repackaged and shipping weights may be converted to dimensional weight.

# HONEY CONTAINERS AND ACCESSORIES



## 3 lb. and 5 lb. Plastic Honey Jugs

With 38 mm Yellow Ratchet Style Lids

### Great Containers for Packing Yard Rent Honey

- M00280** 150 Jugs per Case  
Ship wt. 102 lbs. per Case\*  
1-5 Cases  
**\$107.00 per Case**  
6+ Cases  
**\$104.65 per Case**  
\* See page 144
- M00281** 120 Jugs per Case  
Ship wt. 109 lbs. per Case\*  
1-5 Cases  
**\$110.55 per Case**  
6+ Cases  
**\$107.40 per Case**  
\* See page 144



## Tamper Resistant Seals For 38mm Lids

- M00821** Carton of 250,  
Ship wt. ¼ lb. per carton  
1-4 ..... **\$11.50**  
5+ ..... **\$11.25**

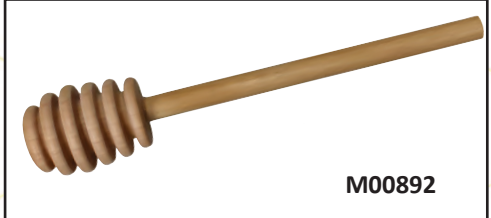

## Wooden Honey Dipper

The classic wooden honey dipper. Sold individually.  
**M00892** Ship wt. 1 lb. .... **\$2.25**

## Shrink Bands Tamper Protection

Make your product tamper resistant. Shrink Band fits over lid. When heat is applied, band shrinks tightly around the base of the lid and container neck. (Hot-air hair dryer works as a heat source).

- M00287, 48 mm Shrink bands** Ship wt. 3 ozs.  
Carton of 250 ..... **\$7.60**      4 Ctns/250 .... **\$26.60 (6.65 ea)**
- M00288, 58 mm Shrink bands** Ship wt. 4 ozs.  
Carton of 250 ..... **\$9.20**      4 Ctns/250 .... **\$29.80 (7.45 ea)**
- M00289, 63 mm Shrink bands** Ship wt. 4 ozs.  
Carton of 250 ..... **\$9.50**      4 Ctns/250 .... **\$35.80 (8.95 ea)**
- M00290, G70 Shrink bands** Ship wt. 6 ozs.  
Carton of 250 .... **\$10.20**      4 Ctns/250 .... **\$35.80 (8.95 ea)**



## Economy Plastic Cut Comb Box

Clear PETE Plastic—3¾" x 3¾"

Excellent Product Visibility—Lightweight  
(use with Comb Cutter, M00938 see page 40)

- M00251** Ctn/50, Ship wt. 3 lbs.  
Ctn/50 ..... **\$16.95 per Carton**
- M002521** Ctn/ 600, Ship wt. 36 lbs.\*  
1-2 Ctns ..... **\$201.85 per Carton**  
3+ Ctns ..... **\$183.70 per Carton**



## Plastic Cut Comb Boxes

4½" x 4½" for Cut Comb Honey

Made from crystal clear hi-impact polystyrene  
(For use with Comb Cutter, M00937 see page 40)

- M00250** Ctn/12, Ship wt. 5 lbs.  
1-9 Ctns ..... **\$23.75 per Carton**  
10 & Up Ctns ..... **\$22.55 per Carton**
- M00253** Ctn/100, Ship wt. 36 lbs.  
1-5 Ctns ..... **\$133.65 per Carton**  
6+ Ctns ..... **\$131.25 per Carton**

Shipments of multiple case quantities may be repackaged and shipping weights may be converted to dimensional weight.

# HONEY CONTAINER LABELS



## Security Labels

Roll of 250

- M01163 48mm . \$20.35
- M01164 58mm . \$20.35
- M01165 63mm . \$20.35
- M01166 70mm . \$20.35



## Botulism Label

1½" x ¾"

M00987 Botulism label

Roll of 250 . . . . . \$10.25



## Liquifying Label

1½" x ¾"

M00989 Liquifying label

Roll of 250 . . . . . \$10.25



## Honey Labels

### Attractive Pressure Sensitive Honey Labels

Yellow, black, and red on white background. Easily applied, peel label from backing and apply to honey jars. Not for use on honey bears.

- M00853 Small Roll Labels, 2⅞" x 2⅜"  
250/roll, Ship wt. 1 lb. . \$7.90 each
- M00854 Large Roll Labels, 3¾" x 3¼"  
250/roll, Ship wt. 2 lbs. \$13.95 each

**Sample 8 oz. Label**

**Nutrition Facts**

Serving Size 1 Tbsp (21g)  
Servings Per Container 11

| Amount Per Serving            | % Daily Value* |
|-------------------------------|----------------|
| <b>Calories</b> 60            |                |
| <b>Total Fat</b> 0g           | 0%             |
| <b>Sodium</b> 0g              | 0%             |
| <b>Total Carbohydrate</b> 17g | 6%             |
| Sugars 16g                    |                |
| <b>Protein</b> 0g             | 0%             |

\*Percent Daily Values are based on a diet of 2,000 calorie diet.

**Actual Label Size:**  
2" wide x 2¾" high

### Nutrition Labels

Pressure Sensitive  
Self Adhesive

|                 |         |
|-----------------|---------|
| 8 oz. . . . .   | M00990  |
| 12 oz. . . . .  | M009905 |
| 1 lb. . . . .   | M00991  |
| 1½ lbs. . . . . | M009915 |
| 2 lbs. . . . .  | M00992  |
| 2½ lbs. . . . . | M009925 |
| 3 lbs. . . . .  | M00993  |
| 4 lbs. . . . .  | M00994  |
| 5 lbs. . . . .  | M00995  |

| Quantity           | Price      |
|--------------------|------------|
| Per 100 . . . . .  | \$6.20/100 |
| Per 500 . . . . .  | \$5.55/100 |
| Per 1000 . . . . . | \$4.95/100 |

Nutrition Labels are for use with Queenline,  
Gamber Glass and Plastic only.

Order from Hamilton Only  
1-888-922-1293

**Custom Honey Labels**  
**Royal Printing, Quincy, IL**  
 ph: 217-222-0617  
 email: [artwork@royal-printing.com](mailto:artwork@royal-printing.com)

# PLASTIC BULK HONEY CONTAINERS



M00206

## 1 Gallon (12 lbs.) Round Plastic Jar

A translucent jar with a wide mouth plastic lid - a superb container for the larger customer.

- ✗ M00206 Carton of 4 with lids.  
Ship wt. 3 lbs. per Carton.
- 1-48 ..... \$9.15 per Carton
- 49+ ..... \$8.35 per Carton

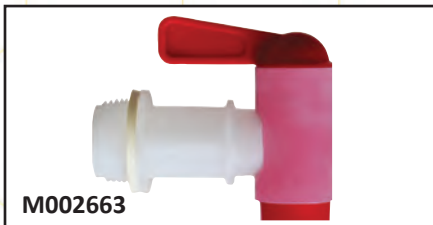

M002663

## 3/4" Plastic Faucet

3/4" Plastic Faucet threads into the center of 2 1/4" screw cap. (Not a clean cutoff with honey). Works best with "thin" liquids. Ship wt. 8 ozs. ea.

- M002663 ..... \$3.60



M00266

## 5 Gallon (60 lbs.) Container

This is molded from high strength translucent plastic and comes with 2 1/4" screw lid. An ideal container for long-term storage or for filling smaller jars by using a gate accessory (**sold separately**). Can be used many times and for many purposes.

- ✗ M00266 Ship wt. 4 lbs., ea.
- 1-44 ..... \$10.75 ea.
- 45-899 ..... \$10.10 ea.
- 900+ ..... \$8.80 ea.

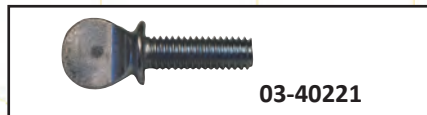

03-40221

## Metal Replacement Thumb Screw

For use with *Dadant's* specially designed 1 1/2" scissor gates M002664 and M005792. Ship wt. 8 ozs. ea.

- 03-40221 ..... \$0.93

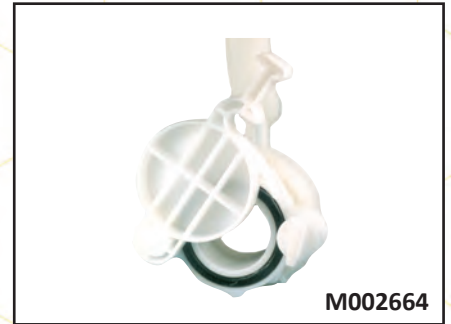

M002664

## 1 1/2" Plastic Scissors Gate In Cap

*Dadant's* specially designed gate mounted in a 2 1/4" screw cap that fits the M00266 container. Adjustable gate, clean cutoff, durable high strength plastic. Ship. wt. 8 ozs. ea.

- M002664 ..... \$19.30

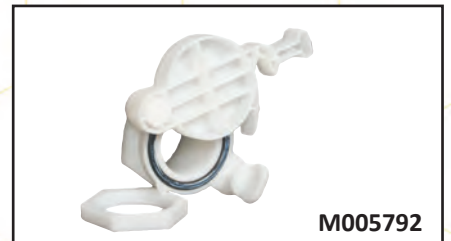

M005792

## 1 1/2" Plastic Scissors Gate

*Dadant's* specially designed gate that fits the M00218 container (pg. 82). Adjustable gate, clean cutoff, durable high strength plastic. Ship wt. 8 ozs. ea.

- M005792 ..... \$13.15



M00212

## 5 Gallon (60 lbs.) White Plastic Pail

Comes complete with tight fitting lid with seal. Bucket is heavy gauge white plastic and has a strong, well-attached bail with hand grip.

- ✗ M00212 Ship. wt. 4 lbs. ea.
- 1-99 Pails ..... \$10.65 ea.
- 400-499 Pails ..... \$9.40 ea.
- 500-999 Pails ..... \$9.10 ea.
- 1000+ Pails ..... \$8.30 ea.



M00238

## 2 Gallon White Plastic Pail

This pail has the same durable characteristics as the 5 gallon pail described above. Comes complete with tight sealing lid and plastic bail with hand grip.

- ✗ M00238 Ship. wt. 1 1/2 lbs. ea.
- 1-99 Pails ..... \$5.60
- 100+ Pails ..... \$5.40



M00320

## Pail Holder Stainless Steel

This tool helps you collect every last drop of honey when transferring honey from a bucket to a storage tank. Clean, neat and no longer do you have to hold the pail while the last of the honey drains out. Simply place pail in holder and move on to the next job while honey drains completely out of the pail. Ship wt. 3 lbs. ea.

- M00320 ..... \$31.45



M009453

## Lid Removing Tool

Lid Removing Tool for Plastic Pails is lightweight, high strength "space age" plastic. Very helpful for removing lids from the 2 and 5 gallon pails.

- M009453 Ship wt. 1 lb. ea. .... \$10.25

Shipments of multiple case quantities may be repackaged and shipping weights may be converted to dimensional weight.

# HONEY REFRACTOMETERS

## Checks Moisture Content of Honey

**Honey Refractometers** are precision instruments made for quick determination of the moisture content of honey. Built-in visual scale covers a range of moisture content. Only a drop of honey is necessary to quickly measure the moisture content.



### Misco Honey Refractometer\*

Great for hobby and commercial beekeepers. The MISCO Refractometer will provide you with an accurate digital reading of your honey's moisture content. Easy to use and understand. Measures moisture w/in +/- .01% Ship wt. 1 lb.

**M00600** Misco Honey Refractometer ..... \$413.55



**Top Quality Refractometers**

- **ATAGO brand**
- **Dependable!!**
- **Accurate!!**

### Pocket Digital Honey Refractometer\*

**M00597** Pocket Digital Honey Refractometer  
Ship wt. 2 lbs. ea. .... \$430.50

\*Top quality Atago brand. World renowned in the food industry for its dependability and accuracy.

**ONLY AVAILABLE at Hamilton, IL location**



### Atago Master Honey Refractometer\*

Top quality Atago Brand. World renowned in the food industry for its dependability and accuracy.

**M01976** Master Refractometer,  
Ship wt. 3 lbs. ea. .... \$339.85



### Standard Refractometer\* High Quality — Low, Low Price!

**M00596** Standard Refractometer,  
Ship wt. 1 lb. ea. .... \$96.25

### Honey Grader

**Jack's Scale** Color Chart with Pfund scale (0-140 mm). Easy to use. Fill the cup and compare. No electricity needed. Pocket size, 2" x 8.5"

**M00598** Jack's Scale, Honey Grader,  
Ship wt. 1 lb. .... \$54.35



\*Cannot ship outside of the U.S.



## STAY INFORMED

The latest beekeeping news delivered monthly to your door for less cost than a cup of coffee

# AMERICAN BEE JOURNAL

**The Beekeeper's Companion Since 1861**

American Bee Journal strives to keep beekeepers informed about new developments, beekeeping management practices, advances in bee research, and beekeeper success stories. With regular columnists and articles from around the globe, this magazine is essential reading for all beekeepers. Features include:

- News and Events, the latest science, book releases & upcoming events
- The Marketplace, a classified section for beekeepers
- The Classroom, a question and answer column written by Jamie Ellis
- Beekeeping Basics by Grant F. C. Gillard
- Scientific Beekeeping by Randy Oliver
- The Curious Beekeeper by Rusty Burlew
- Bees & Beekeeping: Past & Present by Dr. Wyatt Mangum

[www.americanbeejournal.com](http://www.americanbeejournal.com)

**Call or Email for a Free Sample Copy**

1-888-922-1293 or [info@americanbeejournal.com](mailto:info@americanbeejournal.com)



### **Embossed Binder for American Bee Journal**

Protect your back issues of the American Bee Journal - holds 12 issues of ABJ. An attractive "leather look" gold embossed magazine binder. Sturdy vinyl covers open flat.

**M00080 Binder for American Bee Journal \$14.95**

**US Domestic Rates**

1 year \$29.00 M00081  
 2 years \$55.00 M00082  
 3 years \$78.00 M00084

**Canadian Surface Mail**

1 year \$47.00 M000811SC  
 2 years \$90.00 M000821SC

**Foreign Surface Mail**

1 year \$54.00 M000811SF  
 2 years \$99.00 M000821SF

**Digital Subscription**

1 year \$16.00 M00081D  
 2 year \$32.00 M00082D





# DADANT PUBLICATIONS

## The Hive and the Honey Bee 2015 Edition

**M00010**  
**\$56.15**

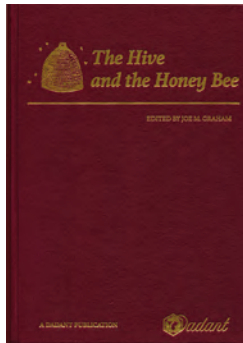

The 2015 edition of *The Hive and the Honey Bee* continues a 162 year tradition started by the father of American beekeeping, the Rev. Lorenzo Lorraine Langstroth. Langstroth entrusted the continuation of this book to his trusted friends Charles Dadant and his son, C.P. Dadant. Over the years "The Bible of American Beekeeping" has been continually updated and enlarged to meet the needs of a growing and changing beekeeping industry. This new edition is 27% larger than the 1992 edition and is composed of 29 chapters written by a staff of 44 beekeeping experts. In addition, it has 660 photos (most of them in 4-color) and 151 drawings, graphs and tables. The 2015 edition is truly a complete beekeeping library in one book. Professionally indexed for easy information searches. Hardcover, 1057 pages. Ship wt. 6 lbs.

## American Honey Plants

**M00125**  
**\$25.70**



Authored by honey plants expert Frank Pellett, this classic book on American honey plants has been reprinted in its entirety. Recognized as the best and most comprehensive book ever written on American honey plants, this volume has been out of print and hard to find for many years. Order your copy now while supplies last! Beekeeping artist Roby Baer has provided a wonderful new color cover that makes this book a true collector's volume. Softcover, 467 pages. Ship wt. 2 lbs.



## First Lessons In Beekeeping

**M00001**  
**\$9.20**

**M00001S**  
**\$9.20**  
*(Spanish version)*



The new *First Lessons in Beekeeping* introduces the prospective beekeeper to the basics of beekeeping through easy-to-understand text and 150 color photos on honey bee biology, beekeeping equipment, management, honey production and processing, as well as disease diagnosis and treatment. In the preface to this book, author Keith Delaplane says of his first book on beekeeping, "Its pages opened to me a golden world of honey bees and beekeeping and guided my stumbling steps that first spring season. My story is but one of thousands who have passed through the door opened by Dadant's little book." That "little book" was the 1968 edition of Charles P. Dadant's 1917 classic *First Lessons in Beekeeping*. Dadant's book and its succeeding editions have been America's first stop for beginning beekeepers for over 90 years. For the latest edition, Delaplane honors the tradition of sticking to the basics, while fully engaging the new realities of beekeeping in the 21st century. Here in this book is everything you need to know to become a successful beginning beekeeper. Also available in Spanish. Softcover, 166 pages. Ship wt. 1 lb.

## Outapiaries and Their Management

**M00030**  
**\$9.20**



This rare volume written by M.G. Dadant was first printed in 1919 and has been out of print for many years. Now Dadant & Sons has reprinted it in its entirety, along with all of its interesting and historical photographs. This is one of the few books in existence written exclusively on the subject of establishing and managing new beeyards. Its good advice is still relevant today and its historical significance makes it a real collector's item. Softcover, 124 pages. Ship wt. 1 lb.

## Dadant System of Beekeeping

**M00029**  
**\$9.20**

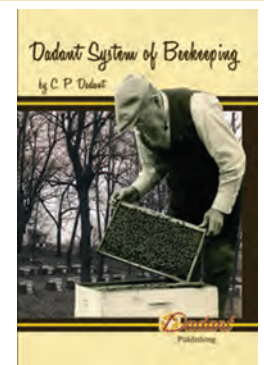

C.P. Dadant's excellent instructional book on his beekeeping methods was popular for many years after it was first published in 1920. Now Dadant & Sons has reprinted it, along with a new cover that features historical photos of C.P. Dadant working his hives, as well as photos of his home beeyard and a personal portrait. This book contains a wealth of practical beekeeping and historical information. Softcover, 115 pages. Ship wt. 1 lb.

Restocking fee of 35% for all pre-approved book returns

[www.dadant.com](http://www.dadant.com)

## Dadant Honey Bee Study Prints

**M00020**  
\$27.75 per set



These 12 beautiful 13" x 18" color enlargements depicting various honey bee behavioral characteristics and beekeeping scenes are excellent for the classroom, bee meetings and exhibits. Ideal for home, office, and honey house display. Printed on the back of each color photo is instructional material—tells what can be observed and learned from the picture, asks questions, gives additional information on the subject, and suggests other sources of information. Ship wt. 2 lbs.

## The Classroom — Beekeeping Question & Answers

**M00069**  
\$12.30

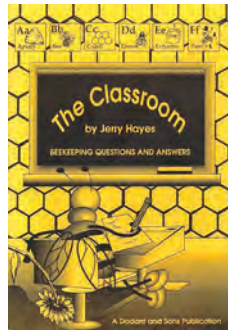

Jerry Hayes, our Classroom writer for the *American Bee Journal*, has put together a huge selection of the most asked beekeeping questions and answers that have been sent to *The Classroom* over the years. Great for the beginner or seasoned veteran. Book chapters deal with management, bee biology, diseases, parasites and treatment, pesticides, swarming, moving bees, pollination, equipment, honey, propolis, stings, queens and much more! Honey gold softcover. 300 pages with photos. Learning really can be fun! Ship wt. 2 lbs.

## Mating Biology of Honey Bees (*Apis mellifera*)

**M02311**  
\$32.95



Authors Gudrun Koeniger, Nikolaus Koeniger, Jamie Ellis, and Lawrence Connor teamed up to write this unique book on the mating biology of honey bees. This hardcover book is amply illustrated with color photos. Bee expert Dr. Marla Spivak at the University of Minnesota says, "Here is a book that allows you to brush up on all the mind-bending details about honey bee mating biology ... Bee sex is complex and beautiful and fortunately, there are still mysteries for future researchers to unravel." Hardcover, 155 pages. Ship wt. 2 lbs.

## Raising Honeybee Queens

**M02315**  
\$29.85



Raise your own superior queens and you'll never need to buy bees again! This fully illustrated guide makes self-sufficient beekeeping accessible to everyone. If you've ever raised queens, this book will give you confidence to start and succeed. If you are an experienced queen breeder, you will find a slew of tips to make each step of the process even better. Learn from a professional queen breeder with over 30 years' experience, and your beekeeping will never be the same after reading this book. Over 150 full-color photographs, drawings, and diagrams. Concise, well-organized guide.

## Contemporary Queen Rearing

**M00065**  
\$12.90

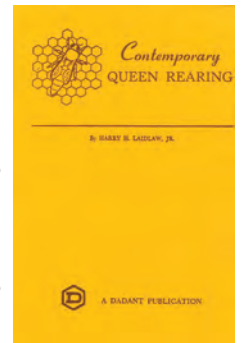

According to the late author, Dr. Laidlaw, "*Contemporary Queen Rearing* is still the best book I have written on practical queen rearing." Information on producing virgin queens, mating the queen, use of queens, package bee production, stock maintenance and much more useful information. Softcover, 199 pages. Ship wt. 1 lb.

## Mites of the Honey Bee

**M00095**  
\$10.25



This is a must-have book for any beekeeper who wishes to understand the tracheal and varroa mite problems in the United States and the potential for control of these two serious honey bee pests. Twenty-seven expert authors have come together to write 18 concise chapters on *Mites of the Honey Bee*. This 300-page hardcover book is amply illustrated with photos, drawings and graphs to augment the text. By Thomas C. Webster and Keith S. Delaplane. Ship wt. 3 lbs.

## History of American Beekeeping

**M00072**  
\$36.05

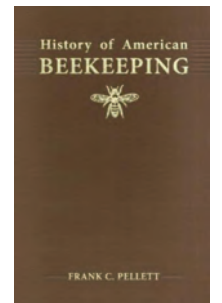

This is one of the few comprehensive books ever written on the history of American beekeeping. Authored by the late *American Bee Journal* editor, Frank C. Pellett, in 1938 this once very rare book has been reprinted in its entirety, along with its original historical photos. This is a fascinating and valuable historical document that details the rise of American beekeeping and the beekeeping pioneers who made it happen. Hardcover, 213 pages. Ship wt. 1 lb.

Restocking fee of 35% for all pre-approved book returns

1-888-922-1293

# INCREASE ENJOYMENT AND PROFIT WITH KNOWLEDGE

## The Small Hive Beetle

*Aethina tumida* Murray

**M02316**  
**\$23.70**

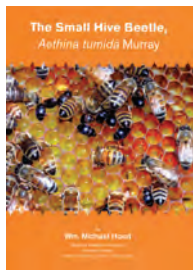

The importance of the role played by honey bee pests in the world is becoming more recognized each year, not only because of attention given to the pest species, such as the varroa mite and small hive beetle, but also because of the increasing realization that honey bees are extremely valuable to nature and humanity. The author, Wm. Michael Hood, is Professor Emeritus of Entomology, Emeritus College, Clemson University, South Carolina, USA Softcover, 142 pages. Ship wt. 1 lb.

## Beekeeping for Dummies

4th Edition

**M02314**  
**\$23.70**

**Everything you need to 'bee' a successful backyard beekeeper**

If you've ever thought about becoming a backyard beekeeper—or have already tried a hand at it and want to be a better one—then this is the book for you! In *Beekeeping for Dummies*, 4th Edition, you'll find everything you need to know in order to start your own colony, including how to assemble and maintain beehives, handle every phase of honey production, purchase and use all the latest tools, and what to do beyond your first season. Softcover, 480 pages. Ship wt. 1 lb.



## Simple Smart Beekeeping

**M01729**  
**\$25.75**



Author Kirsten Traynor does a wonderful job in providing a beginner's beekeeping book "to help streamline your beekeeping success." *Simple, Smart Beekeeping* will guide you through your early years of beekeeping, helping you recognize what is happening in your hive. Short informative chapters cut through all the jargon and tell you just what you need to know. Wonderfully illustrated with 190 photos shot in the field. Softcover, 180 pages. Ship wt. 1 lb.

## Honey Bee Diseases and Pests

3rd Edition

**M000131**  
**\$18.50**

This publication was prepared by the Canadian Association of Professional Apiculturists to assist beekeepers in preventing serious disease-related damage to their hives. Excellent color photos. Perfect for the hobbyist and a good addition for the experienced beekeeper. Softcover. 68 pages. Ship wt. 1 lb.



## Honey Bee Biology and Beekeeping

**M00073**  
**\$56.65**



The new edition of this excellent beekeeping textbook has been extensively revised and updated by author Dewey M. Caron with the help of Lawrence John Connor. Since its original release in 1999, *Honey Bee Biology and Beekeeping* has become a widely accepted beekeeping textbook. It concentrates on the "why", "how" and "when" of beekeeping, while explaining bee and beekeeping basics in a manner meaningful to people who lack an intensive biology background. Nicely illustrated with many color photographs. Hardcover, 368 pages. Ship wt. 3 lbs.

## The Beekeeper's Problem Solver

**M02310**  
**\$20.60**

Author James Tew writes about 100 common problems that beekeepers might encounter while working their bees or extracting their honey. Dr. Tew answers these questions in clear and simple terms. From hive management to diseases and from equipment to honey production, each key area is tackled in depth, with photographs, practical tips, and useful insights. Softcover, 223 pages. Ship wt. 2 lbs.



## Natural Beekeeping by Ross Conrad

**M00049**  
**\$36.05**

Author Ross Conrad has been hailed by many beekeepers for his "organic approaches to modern apiculture." Ross believes that many beekeeper disease and pest problems can be solved without using harmful chemicals. With news that some chemical honey bee disease and pest treatments are no longer working, Ross says, "It's time for a new approach. *Natural Beekeeping* offers a holistic, sensible alternative to conventional chemical practices by proposing a program of natural hive management." Softcover, 240 pages. Ship wt. 2 lbs.



## The Beekeeper's Handbook

**M00094**  
**\$28.35**

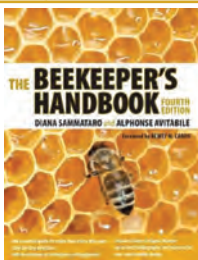

Written by Diana Sammataro and Alphonse Avitabile, this 190 page beekeeping instructional manual has been hailed by many as one of the best beginner's books written in recent years. A glossary and bibliography are also provided suggesting more detailed information on the topics discussed. Softcover. Fourth edition. Ship wt. 2 lbs.

Restocking fee of 35% for all pre-approved book returns

[www.dadant.com](http://www.dadant.com)

## Comb Honey Production

M02313  
\$26.80

Wicwas Press has reprinted Dr. Roger Morse's classic book on the specialized art of comb honey production. No other beekeeping product on the market is more natural or more delicious than comb honey. Even though comb honey production might eliminate your need for some costly honey house equipment such as extractors and bottlers, this specialized form of honey production requires a few changes in your bee management in order to maximize your comb honey yield, while not sacrificing any quality. Softcover, 128 pages. Ship wt. 2 lbs.

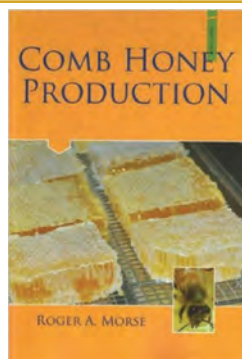

## Commercial Beekeeping: A Field Guide

M02318  
\$22.65

Bee Informed Partnership's "Commercial Beekeeping - A Field Guide" pocket guide is full color and has 269 pages of information. Dimensions of 4 x 6 x 0.5". Three years in the making, this publication includes a wealth of information that covers everything beekeepers may want to know to improve their beekeeping and take their operation to the next level. Softcover.

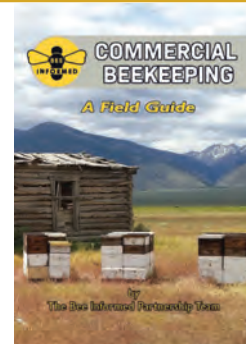

## The Backyard Beekeeper

4th Edition  
M019804  
\$25.75

*An Absolute Beginner's Guide to Keeping Bees in Your Yard and Garden*

Now in its 4th edition, makes the time-honored and complex tradition of beekeeping an enjoyable and accessible backyard pastime that will appeal to urban and rural beekeepers of all skill levels. What's New? - Information for Urban Bees and Beekeepers - Using Your Smoker the Right Way - Better Pest Management - Providing Consistent and Abundant Good Food - Keeping Your Hives Healthy. With this complete resource and the expert advice of former Bee Culture editor Kim Flottum, your bees will be healthy, happy, and more productive. Softcover, 240 pages. Ship wt. 2 lbs.

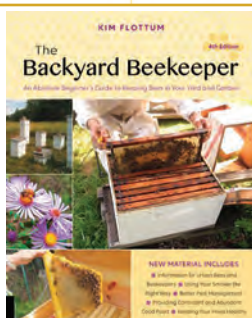

## Bee-sentials — A Field Guide

M00077  
\$25.75

A beekeeping book you have been looking for--a basic book with some 'meat on its bones' for continued study by new and not-so-new beekeepers. This is a book that can be thrown into a computer bag or backpack and read on an airplane or beside a lake in the woods. 25 Colorful pages of honey plants. Softcover, 208 pages. Ship wt. 1 lb.



## Attracting Native Pollinators

M00111  
\$30.85

Bees, wasps, butterflies, moths, flies and some beetles pollinate more than 70 percent of flowering plants, but North America's native pollinators face multiple threats to their health and habitat. The Xerces Society offers a complete action plan for protecting these industrious animals by providing flowering habitat and nesting sites. Softcover, 371 pages. Ship wt. 3 lbs.



## Two Million Blossoms —

*Discovering the Medicinal Benefits of Honey*

M00120  
\$20.55

Author Kirsten Traynor has carefully researched and interviewed many experts for this well written and informative book that chronicles the medicinal use of honey "from ancient civilizations until the advent of antibiotics." "New scientific findings from around the world demonstrate honey heals chronic wounds, beats antibiotic-resistant superbugs, eliminates tissue scarring, reduces brain damage, improves memory and minimizes the harmful side-effects of cancer treatments. An easily assimilated antioxidant, honey proves more effective than over-the-counter cough medicines, acts as a natural laxative, stimulates good intestinal flora, and alleviates spring allergies." Softcover, 258 pages. Ship wt. 2 lbs.



## Honey Bee Hobbyist

M000082  
\$17.45

Discover whether honey beekeeping is right for you, and find out everything you need to know to keep and acquire bees in this updated guide. Honey Bee Hobbyist, 2nd Edition will help novice beekeepers fully understand this exciting pastime. Dr. Norman Gary, a world-renowned honey bee expert and enthusiast, counsels beginners on all things honeybee related. He takes readers from finding bees and housing them to collecting honey and using their produce for pleasure and possible profit. More than 100 fascinating color photographs and tips and tricks acquired over half a century of beekeeping. Softcover, 224 pages. Ship wt. 2 lbs.



Restocking fee of 35% for all pre-approved book returns

1-888-922-1293

## Queen Rearing and Bee Breeding

**M02312**  
**\$51.50**

World famous Professor Harry H. Laidlaw and his former student, Dr. Robert E. Page, Jr., worked together to write this excellent specialized book on queen rearing and bee breeding. Topics discussed run the gamut from the nuts and bolts of commercial queen rearing to more individualized queen rearing for the smaller queen producer. Queen biology and genetics are discussed, as well as more specialized topics such as instrumental insemination of queen bees. Softcover, 224 pages. Ship wt. 2 lbs.



## Applied Beekeeping in the United States

**M01734**  
**\$45.50**



The beginner as well as the experienced professional will garner a hive full of information from Applied Beekeeping in the United States. Honeybee information has been compiled and published in book form in hopes that beekeepers in the United States and worldwide will benefit. There are many topics in this book not contained in more theoretical books and through 342 pages, supplemented by 246 full-color photographs, both the novice and experienced beekeeper will take away new knowledge. Hard cover, 342 pages. Ship wt. 1 lb.

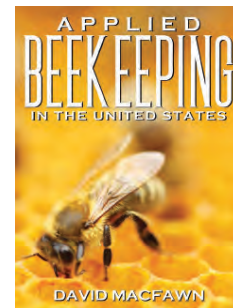

## Scientific Queen-Rearing

**M00097**  
**\$20.60**

G.M. Doolittle first published this classic book on queen rearing in 1889. Mr. Doolittle spent over two decades researching and testing the ideas he outlined in his book. Now considered essential to the development of the modern queen rearing industry, the book describes how beekeepers are able to use the instincts of the hive to produce quality queens. Reprinted by Dr. Larry Connor's Wicwas Press. 101 pages, Softcover. Ship wt. 1 lb.



## Queen Rearing Essentials

**2nd Edition**

**M019642**  
**\$23.70**

Author Larry Connor has revised and updated his original version of this very practical book on rearing queen bees. The many beautiful color photos are immensely helpful. "This book is one-stop shopping for all you need to know to raise your own queens. A terrific update with all the latest information by the premier teacher of how to raise queens. Highly recommended!" — Dan O'Hanlon, President, West Virginia Queen Producers. Softcover, 160 pages. Ship wt. 1 lb.



## Increase Essentials -

**2nd Edition**

**M00023**  
**\$25.75**

Author Dr. Lawrence Connor continues his Bee Essentials series with this excellent guide on how beekeepers can use nuclei to solve problems in the beeyards and use them to winter colonies and provide a reliable source of fresh bees, locally acclimatized queens, replacement hives and colonies for operational growth or sale. Second edition, softcover, 176 pages. Ship wt. 1 lb.

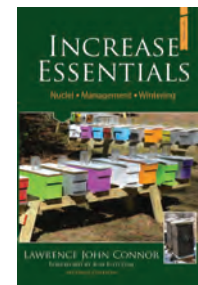

## Honey—Nature's Golden Healer

**M00032**  
**\$20.55**

Author Gloria Havenhand believes that honey bees, the origin of many pharmaceutical drugs, have been forsaken and forgotten—to our cost. She now manages a number of honey bee colonies and runs Medibee, a bee product company. With an increasing number of people interested in ditching drugs for natural alternatives to combat health problems from allergies to acne, this book is a timely look at how the beehive can help us look and feel better. Beautiful color photography. Softcover, 160 pages. Ship wt. 1 lb.



## Bee Sex Essentials

**M00112**  
**\$25.75**

*Bee Culture/American Bee Journal* writer Dr. Larry Connor reviews the latest and essential knowledge of drone and queen production, mating and genetics. He clearly and concisely shows how the sex life of bees directly impacts the fate of the colony and, in turn, the success of the beekeeper. He outlines a sample bee-breeding program for a sideline beekeeper with fewer than 100 colonies who wants to produce queens from survivor, locally-adapted and mite-resistant lines. Softcover, 152 pages. Ship wt. 1 lb.

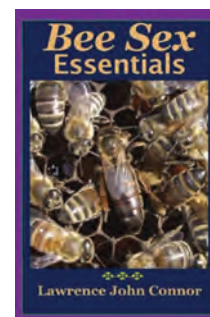

Restocking fee of 35% for all pre-approved book returns

[www.dadant.com](http://www.dadant.com)

## Honey from the Earth

**M01735**  
**\$66.90**



The internationally acclaimed honey-bee photographer Eric Tournernet

spent fifteen years traveling the world to capture the breathtaking diversity of bees and beekeeping traditions on six continents. This is by far the most stunning collection of bee photography ever produced, complete with insightful commentary from a dozen leading bee experts, including Dr. Tom Seeley, Dr. Jurgen Tautz, and Kirk Webster.

## Diagnosis & Treatment of Common Honey Bee Diseases

2nd Edition

**M02317**  
**\$36.05**

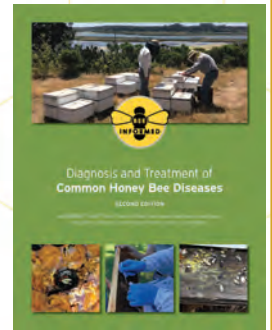

Bee Informed Partnership's newly revised edition of "Diagnosis and Treatment of Common Honey Bee Diseases" manual is a 66 page spiral bound with laminated front and back cover sheets that includes detailed images and descriptions of the signs of diseases a beekeeper may encounter in their hives. This manual also goes into how to best treat or address the common diseases that honey bees face.

## Bee Club Basics

*How to Start a Bee Club*



**M02319**  
**\$36.05**

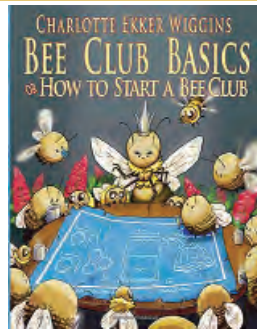

What does a coffee pot have to do with beekeeping? Are you a beekeeper who wants to join forces with others? Are you a 'newbie' who wants to learn about beekeeping? Or maybe you just want to start a non-profit club. Charlotte Ekker Wiggins offers you pages and pages of advice of suggestions on how to meet new friends, come together for a common purpose and maybe even find 'family' with each other. AND, it's FUN! Softcover, 198 pages.

## The Bee Book

**M00422**  
**\$25.75**



Bees are vital to the future of the planet, yet they are under threat and in decline. The Bee Book offers remarkable insights into their world and shows how we can support and enjoy them in our daily lives. Chapters include: An Amazing World of Bees; Attracting Bees; Caring for Bees; and Enjoying Bee Bounty. Many beautiful color photos and a very helpful section on incorporating honey and bee products in recipes, crafts, and home remedies. Hardcover, 221 pages. Ship wt. 2 lbs.

## Bee — Close-up Photography of the Bee

**M00423**  
**\$23.70**



Photographer Rose-Lynn Fisher has compiled a wonderful portfolio of honey bee anatomy photographs that are truly amazing! These close-up photos and precise descriptions take the reader on a fantastic tour of the honey bee's anatomy that most of us have never imagined to exist. This is an important book for beekeepers in order for them to truly understand the marvelous creature they have come to know through their craft. Softcover, 128 pages. Ship wt. 1 lb.

## Following the Wild Bees — The Craft and Science of Bee Hunting

**M00427**  
**\$23.65**

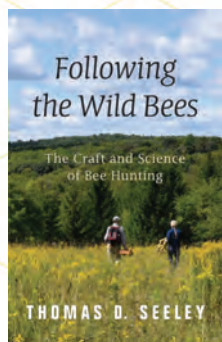

Thomas D. Seeley, world famous bee behavior scientist, has written a delightful book on the lost art of bee hunting. Dr. Seeley vividly describes the history and science behind this lost pastime and how anyone can do it. The book is both a unique meditation on the pleasures of the natural world and a guide to the ingenious methods that compose the craft of the bee hunter. Hardcover, 164 pages. Ship wt. 1 lb.

## A Year's Work in an Out-Apiary

**M00426**  
**\$20.60**

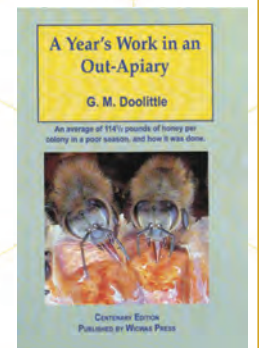

One hundred years ago G.M. Doolittle developed honey production methods that eliminated swarming. This Centenary Edition includes all his original work plus added materials: A table of contents, an index, the 1897 interview written by E. R. Root, and study questions. Softcover, 114 pages. Ship wt. 1 lb.

Restocking fee of 35% for all pre-approved book returns

1-888-922-1293

## DVD's

### Natural Beekeeping by Ross Conrad - (DVD)

M00049DVD  
\$30.85

This DVD is a comprehensive survey of natural beekeeping, its principles and practices, aimed at both hobby and small-scale commercial apiculturists. In this filmed workshop, noted Vermont beekeeper Ross Conrad flips the script on traditional approaches by proposing a program of selective breeding and natural hive management. The video presents a comprehensive survey of natural beekeeping methods and challenges, including segments filmed in the field. It offers practical information that every aspiring beekeeper needs to know — everything from basic hive equipment to working with your bees to harvesting and processing honey. *Video time:* 193 minutes. Ship wt. 4 ozs.



### Natural Beekeeping - (DVD) Organic, Non-Disruptive Apiarian Methods

by Jerry Dunbar

M01720  
\$30.85

“Organic, Non-Disruptive Apiarian Methods” For more than 40 years Jerry Dunbar has been developing ways of working with honey bees in a manner that creates the least possible interference and encourages their health and future survival. *Video time:* 87 minutes. Ship wt. 4 ozs.



### Swarm plus - (DVD) An Incredible, Up-Close Look at the Amazing Honeybee

M00096  
\$24.70

This expertly done instructional DVD teaches the beekeeper about honey bee swarming and includes: Nine swarms, Feral colony, After the catch, Bee removal, Equipment, plus a Bonus video. The narrator demonstrates how to catch a variety of swarms in many different circumstances. A fun, instructional, and entertaining video. *Video time:* 58 minutes. Ship wt. 4 ozs.

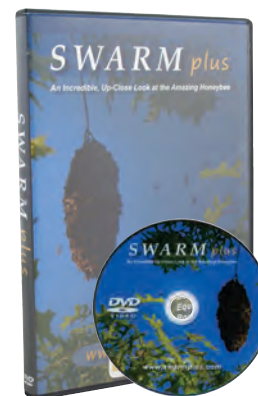

### More Than Honey - (DVD)

M00107  
\$30.85

This informative DVD by Academy Award-nominated director Markus Imhoof tackles the vexing issue of why bees, worldwide, are diminishing in numbers. With the tenacity of a man out to solve a great mystery, he investigates this global phenomenon, from California to Switzerland, China and Australia. “Exquisite macro-photography of bees in flight and in their hives reveals a fascinating, complex world in crisis.” *Video time:* 91 minutes. Ship wt. 3 ozs.



Restocking fee of 35% for all pre-approved book returns

[www.dadant.com](http://www.dadant.com)



**Bees—Tales from the Hive - (DVD)**

**M00052  
\$36.05**

Discover new found facts about the strange and complex life of bees in this in-depth documentary. It features up-close footage filmed with specially developed macro lenses. Witness the most intimate and spectacular portrayal of a working bee colony. From a high-speed mid-air “wedding flight” to a close encounter with honey-loving bears, this Nova DVD exposes a bee colony’s secret world. Video time: 54 minutes. Ship wt. 3 ozs.



**Instrumental Insemination of Honeybee Queens (DVD)**

**M00047  
\$31.85**

Susan Cobey, world-renowned expert on honey bee queen insemination, shares her 25 years of experience in teaching this important technical skill that is vital to modern bee breeding. She also has 30 years of experience at single-handedly developing and maintaining a closed breeding program to produce her New World Carniolan bee stock. Her love of beekeeping and teaching shines through in this 30-minute DVD instructional program. Ship wt. 2 ozs.

**DVD’S AND/OR BOOKS**



**Honey Bees & Beekeeping — A Year in the Life of an Apiary**

*Honey Bees & Beekeeping* by Keith S. Delaplane, Ph.D., is an eight episode video series and companion book designed to teach novices the

basics of beekeeping and to give more experienced beekeepers expanded knowledge. The videos trace the development of ten honey bee colonies from start-up through a complete year of management.

**Book:** *Honey Bees and Beekeeping: A Year in the Life of an Apiary* complements the videos. Softcover, 108 pages. Ship wt. 2 lbs

**M00099 Book only - \$20.55**

**DVD Series**—All eight 30 minute episodes are presented on DVD. Ship wt. 2 lbs.

**M00100DVD DVD series only - \$41.15**

**M00100SETDVD  
DVD Series/Book Set  
\$59.70/set  
Ship wt. 3 lbs.**



**Honey In The Comb — Book and/or DVD**

By Eugene E. Killion. Twelve comprehensive chapters cover every aspect of comb honey production in both round and square sections. 165 brand new photographs and equipment drawings, completely cross-indexed. softcover in honey gold, 148 pages. Also, don’t miss the video by Gene Killion complementing his book of the same title. An excellent guide and aid for the novice and experienced beekeeper alike.

**Book only Ship wt. 3 lbs.  
M00006 - \$10.80**

**DVD only Ship wt. 1 lb.  
M001242DVD - \$20.55**

**DVD/Book Set Ship wt. 4 lbs.  
M00006SET - \$30.40**

*Restocking fee of 35% for all pre-approved book returns*

**1-888-922-1293**



# CHILDREN'S BOOKS

## Sweet Sophia Series

Follow Sweet Sophia as she travels through time, meets awesome people, and spreads the word about honey bees. Softcovers.

Set of 3  
M00229  
\$28.35

### SWEET SOPHIA GOES TO MOUNT VERNON

In this adventure Sweet Sophia meets George and Martha Washington plus shares her honey cherry turnover recipe! 58 pages.

### SWEET SOPHIA MEETS CLEOPATRA

In this adventure Sweet Sophia meets Cleopatra and learns about bees and honey in ancient Egypt. She also shares her Sweet Honey Baklava recipe! 49 pages.

### SWEET SOPHIA VISITS FLORENCE NIGHTINGALE

In this adventure Sweet Sophia visits Florence Nightingale in a London Hospital and learns about the wonderful work nurses do and how honey can be used in healing. She also shares her delicious Honey Oatmeal Cookie recipe at the end of the book! 53 pages.

Ship wt. (set of 3) 1 lb.



## Andy the Ant Have Bees Will Travel

M01732  
\$16.45

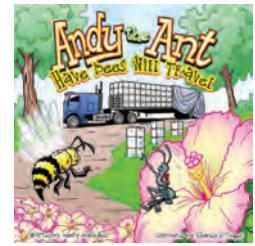

A must have academic resource for the budding young scientists in your life. This informative book takes readers on a journey of the migratory bees. Andy the Ant will help them discover the importance of these special bees that are transported great distances to farms and orchards for pollination. It also shows how commercial beekeepers care for them. Ship wt. 1 lb.

## Honey Bee Charli

M01719  
\$15.40

Have you ever wondered about the life of a honey bee? Go along with Charli as she makes an exciting discovery while exploring out beyond the hive. Share her adventure-filled day and find out the important lesson she learns! Hardcover, 29 pages. Ship wt. 1 lb.



## Grandpa's Hidden Gold Farm

M00405  
\$8.25



You might not expect to discover gold on a farm, but Grandpa knows just where to find this hidden treasure — in his bee yard! Dig into Grandpa's Hidden Gold Farm for some sweet (and yummy) fun while learning about the beekeeping! Softcover, 26 pages. Ship wt. 0.25 lbs.

## Busy as a Bee—The Cat in the Hat knows a lot about that!

M01725  
\$10.30

Join the Cat in the Hat on a buzzing adventure to find out how honey is made! This children's book comes complete with big two-sided crayons and easy-wipe-off pages, so you'll be able to draw with the cat over and over again! Hardcover, 12 pages. Ship wt. 2 lbs.



## Andy the Ant Learns the Buzz On Bees

M00104  
\$20.60



Learn the Buzz on Bees! This is a colorful children's book on bees written by Nancy Blackwell and illustrated by Charles Ettinger. Join Andy the Ant as he treks through an exciting adventure inside a beehive with his new friend, Beatrice the Bee. Activities in the back of the book include some tasty honey recipes for kids to try at home. Hardcover, 32 pages. Ship wt. 1 lb.

## The Berenstain Bears and the Missing Honey

M01724  
\$5.15

Join the Berenstain Bears as they try to solve the case of the missing honey. You'll never guess who the honey thief is! This book is one of many from this excellent series written by Stan & Jan Berenstain for young readers. Softcover, 29 pages. Ship wt. 1 lb.

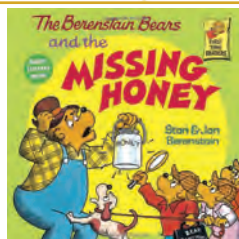

Restocking fee of 35% for all pre-approved book returns

www.dadant.com

### Give Bees A Chance

**M00429**  
**\$17.50**

Not sure whether to high-five bees or run away from them? Well, maybe you shouldn't high-five them, but you definitely don't have to run away from them. Give Bees a Chance is for anyone who doesn't quite appreciate how extra special and important bees are to the world, and even to humankind! Besides making yummy honey, they help plants grow fruits and vegetables. And most bees wouldn't hurt a fly (unless it was in self-defense!). Hardcover, 40 pages. Ship wt. 1 lb.



### Beauty and the Bees

**M00234**  
**\$7.95**

Join Beauty in this farm-friendly adaptation of a timeless fairy tale that reminds us of how sweetness can be found in unexpected places. Softcover, 25 pages. Ship wt. 1 lb.

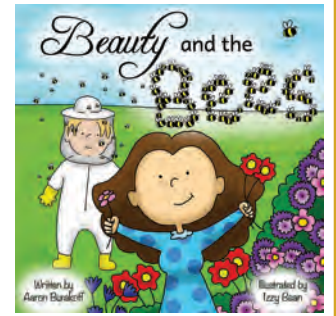

### Honeybees— Jump into Science

**M01726**  
**\$7.15**

This National Geographic children's book uses colorful artwork and easy-to-understand descriptions to explain the life history of honey bees. The end of the book has several excellent ideas for children to act out interesting aspects of honey bee behavior. Softcover, 31 pages. Ship wt. 1 lb.



### In The Trees, Honey Bees

**M00025**  
**\$9.20**

Children love to learn about honey bees and are fascinated by this industrious and ingenious social insect. Author Lori Mortensen and illustrator Cris Arbo have teamed up to create this award-winning children's book on the honey bees. Cris Arbo's wonderful color artwork is a real attention-getter and is sure to keep children glued to each page as they learn about the honey bee colony. Softcover, 30 pages with color artwork. Ship wt. 1 lb.

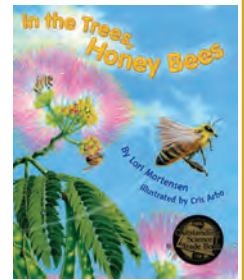

### Step into Reading — Show Me the Honey

**M01727**  
**\$4.10**

This Step into Reading book has the Cat in the Hat telling kids where honey comes from as he takes you inside a beehive. Beautifully illustrated and written for children in grades 1-3. Softcover, 48 pages. Ship wt. 1 lb.

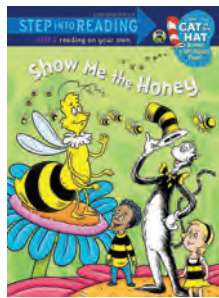

### The Berenstain Bears and The Big Honey Hunt

**M01723**  
**\$9.25**

This beginning to read book by Stan and Jan Berenstain centers around Papa Bear as he tries to find some honey, but somehow things go wrong and he gets into lots of funny trouble with angry bees. Wonderfully illustrated. Hardcover, 63 pages. Ship wt. 1 lb.

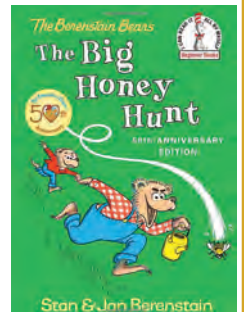

## NOTEPADS / POSTER

### Bee Coloring Book

Ideal for the children. Attention getting coloring book. Children have fun coloring while they learn about bees and honey. Fun activities are also included. 24 pages. Ship wt. 8 ozs.



**M000501**

**1-99** ..... **\$0.36**  
**100-999** ..... **\$0.31**  
**1000+** ..... **\$0.21**

### Honey Bee Life Cycle Chart

**M00002**  
**\$15.10**

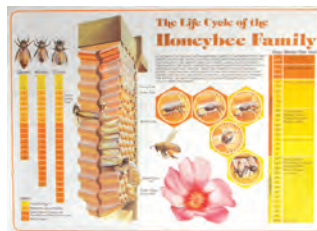

Great for classroom bee talks or beekeeping exhibits. Poster size. 21 1/4" x 33" Ship wt. 1 lb.

### The Bee You See Coloring Book

**M00233**  
**\$11.30**

Interesting Facts and more are explained in this fun coloring book that is designed to introduce you to honeybees and the art of beekeeping! Learn how to set up a hive or discover when honeybees first came to America.



Restocking fee of 35% for all pre-approved book returns

1-888-922-1293

# RECIPE BOOKS

## The NEW Honey Revolution — Restoring the Health of Future Generations

**M01986**  
**\$20.55**



This revised and updated edition contains information from all the books in The Honey Revolution Series, PLUS new information from dozens of new research studies documenting the amazing health benefits of consuming honey. In The New Honey Revolution you will discover how: Honey regulates blood sugar and is the sweetener of choice for diabetics. Honey can help you sleep better and recover faster. Honey reduces the risks for obesity, diabetes and heart disease, Softcover, 234 pages. Ship wt. 1 lb.

## The Hibernation Diet

**M00040**  
**\$15.40**

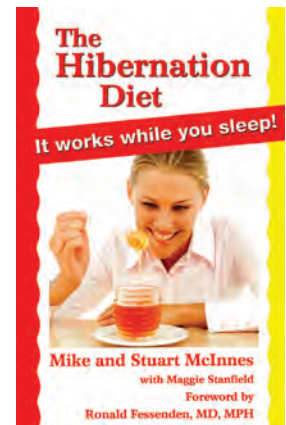

The Hibernation Diet works while you sleep! Authors Mike and Stuart McInnes have created a real media stir with their new book and have been the subjects of numerous newspaper, magazine, radio and TV interviews about their wonderful new diet. What's the key to this diet working? — a spoonful of honey taken before bed every night! What could be easier than that! Softcover, 183 pages. Ship wt. 1 lb.

## Hive Inspection Sheet Notepad

**M01940**  
**\$3.35**



Hive Inspection Sheets to help record hive activity, requeening, treatments, feeding, honey storage, honey extraction, and the condition of the hive. Notepad is made up of 25 sheets with pre-drilled holes to fit into a 3-ring binder. Ship wt. 1 lb. ea.

## Honey & Oats

**M01728**  
**\$30.85**

Author Jennifer Katzinger describes her cookbook as “everyday favorites baked with whole grains and natural sweeteners.” Seventy-five mouth-watering recipes include Banana Buckwheat Pecan Muffins, Apple Pie, Sweet Potato Skillet Corn Bread, Honey Spice Cake and Chocolate Chip Cookies. Enjoy healthier versions of your favorite baked goods! Hardcover, 160 pages. Ship wt. 2 lbs.

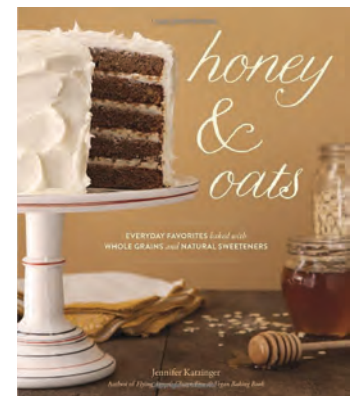

## Essential Book of Homesteading

**M00428**  
**\$25.70**

In barnyards and backyards, on rooftops and in alleyways, a movement is happening—the modern homesteading movement. Whether it's turning a lawn into a vegetable garden, getting a flock of chickens, or transforming cucumbers into pickles, people everywhere are taking charge of their own food supply. Ashley English, a major figure in the return to homesteading, gives newcomers her time-honored tips for successfully overseeing food production in their own homes. Totally updating material from her phenomenal homesteading books—Keeping Bees, Keeping Chickens, Canning & Preserving, and Home Dairy—this collection covers everything from preserving jams and jellies to whipping butter and keeping a hive of honeybees. Ashley provides entry points, troubleshooting tips, and inspiration for putting the food your family consumes back in your own hands. Hardcover, 168 pages. Ship wt. 3 lbs.

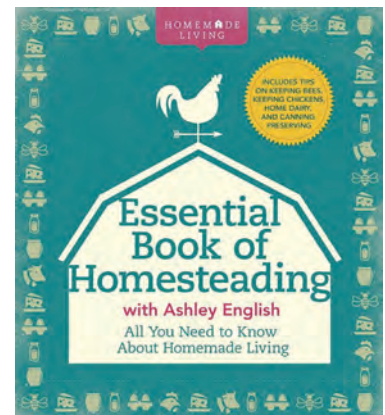

Restocking fee of 35% for all pre-approved book returns

[www.dadant.com](http://www.dadant.com)

# RECIPE BOOKS

## Joy With Honey - 5<sup>th</sup> Edition

M00121  
\$18.50



The 5th edition of this popular honey recipe book advertises “300 recipes you’ll love!” Doris Mech, retired beekeeper, teacher and creative cook, shares her favorite honey recipes in this 5th edition. You will find Chewy Granola Bars, Blackberry Lemonade, Super Bowl Chili and Dreamy Chocolate Decadence as additions to this new edition. Spiral bound, softcover, 198 pages. Ship wt. 1 lb.

## The Fresh Honey Cookbook

M00105  
\$15.40

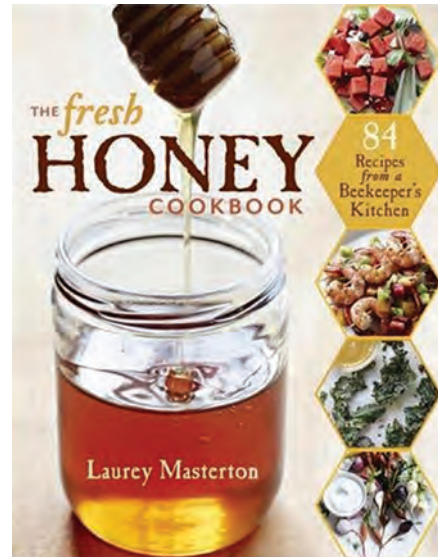

84 recipes from a Beekeeper’s Kitchen. Highlighting a different varietal honey each month, beekeeper and chef Laury Masterton offers honey-tasting tips and vibrant recipes that deliver amazing dishes, both savory and sweet. Softcover, 207 pages. Ship wt. 2 lbs.

## Honey, I’m Homemade *Sweet Treats From the Beehive Across the Centuries and Around the World*

M00011  
\$22.60



Edited by May Berenbaum, professor of Entomology at the University of Illinois at Urbana-Champaign, this honey cookbook showcases a wealth of recipes for cookies, breads, pies, puddings, and cakes that feature honey as an essential ingredient. At the same time, Prof. Berenbaum details the fascinating history of honey harvesting and consumption around the world, explains the honey bee’s extraordinary capacity to process nectar into concentrated sweetness, and marvels at honey’s diverse flavors and health benefits. Sales of the book will benefit the University of Illinois Pollinatorium — the first freestanding science outreach center in the nation devoted to flowering plants and their pollinators. Softcover, 163 pages. Ship wt. 1 lb.

## Cooking with My Honey

M00071  
\$20.55

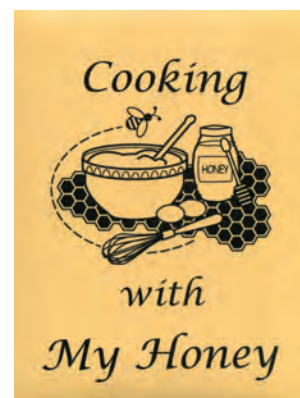

A collection of honey recipes by the East Texas Beekeepers Association, this new cookbook is handy to use with its spiral bound notebook style format. Sections cover Appetizers and Beverages; Soups and Salads; Vegetables and Side Dishes; Main Dishes, Breads and Rolls; Desserts; and Cookies and Candy. Hardcover, 116 pages. Ship wt. 2 lbs.

Restocking fee of 35% for all pre-approved book returns

1-888-922-1293

# CRAFT AND HOBBY BOOKS



M01170



M01170  
\$46.40

Make breakfast extra special with whimsical, honey bee-motif pancakes that honor this humble, hardworking and highly revered pollinator. Each of the 7 pancakes will have a sweet, detailed image browned into it of a honeycomb, flower, hive or busy bee. Crafted of cast aluminum in the USA this sturdy pan features a stay cool handle plus PFOA-free nonstick to make turning pancakes and cleaning a breeze. Works with mixes or any favorite pancake recipe. 17¼" x 16" x 2¼" Ship wt. 2 lbs. ea.

## Honey Bees Cookie Stamps

M01162  
\$46.30



- Cast Aluminum with Wooden Handles
- Makes 3 different styles - 3" Round Cookies
- Limited Lifetime Warranty by manufacturer
- Made in America
- Hand wash

Ship wt. 3 lbs. ea.

## Beehive Cakelet Pan

M01161  
\$46.30



- Cast Aluminum
- Interior Dimensions: 3 cups 2.78"L x 2.68"W x 2"H/ cavity
- Lifetime Warranty by manufacturer
- Made in America
- Hand wash

Ship wt. 3 lbs. ea.

## Bee Hive Cake Pan

M01160  
\$46.30

Our decorative cake pan does the work of hundreds of buzzing bees – with incredibly sweet results. Just fill both sides with batter, then bake. Adorned with bees, the two halves emerge ready to be pressed together with icing and decorated to form the 7" diam., 6" high cake. The cast-aluminum pan's nonstick finish ensures easy release. Hand-wash. 16" x 7¼" x 3½" high. Ship wt. 3 lbs. ea.



## Honeycomb Cake Pan

M01261  
\$46.30

Our exclusive heavy cast aluminum Bundt Bakeware provides superior baking performance. Baked goods rise evenly, cook uniformly, and are finely detailed thanks to the excellent thermal conduction of the heavy walls. A special heat-reflective exterior and premium nonstick surface assures perfect results. Our unique pans are wonderful for bread, molded desserts and savory dishes, as well as cake. Hand wash. 12¼" x 11¼" x 2¼" Ship wt. 3 lbs.

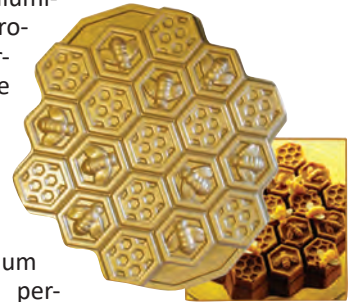

## Creating Candles

M03002  
\$27.75

With over a hundred unique projects and more than a thousand beautiful photographs this book is a must-have guide for candle makers. Precise instructions accompany each photo. From designing a candle for special occasions to simply adding a decorative touch to any table, this book offers ideas using a wide variety of materials. It also includes creative variations and gift wrap suggestions for each candle. Softcover, 223 pages. Ship wt. 1 lb.

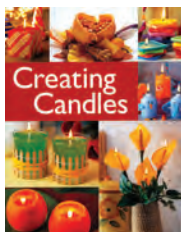

## The Candlemaker's Companion

M00022  
\$21.60

From wax to wick to wrapping, the magical glow of a handmade candle is now easier to create than ever before. Illustrated step by step instructions show you how to roll, pour, mold and dip candles. A great book for beginners and experienced candlemakers. Softcover. 199 pages. Ship wt. 2 lbs.

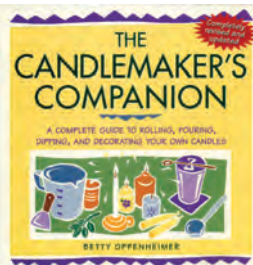

## Basic Candle Making

M03001  
\$20.55

This is a wonderful instructional book. Author Scott Ham gives detailed step by step instructions with full color photographs to show how to craft molded, tapered, container and rolled beeswax candles. Spiral bound, softcover, 104 pages. Ship wt. 1 lb.



Restocking fee of 35% for all pre-approved book returns

www.dadant.com

# CRAFT AND HOBBY BOOKS CONT.

## The Soapmaker's Companion

**M00021**  
**\$19.95**

Susan Cavitch leads you through every step of the soapmaking process with clear step by step instructions. She includes tips on how to start selling soaps. Softcover, 281 pages. Ship wt. 1 lb.



## Melt & Mold Soap Crafting

**M04003**  
**\$15.40**

Soapmaking has never been this easy! The revolutionary melt-and-mold method is taking the craft world by storm. Beginning with a meltable glycerin base, crafters can create stunning specialty soaps in minutes, with no lye and no waiting. It's as easy as melt, pour, mold, and decorate. Softcover, 144 pages. Ship wt. 1 lb.



## The Compleat Meadmaker

**M00036**  
**\$20.55**

The title says it all. This is *the* book for the serious meadmaker. Authored by Ken Schramm, a well known expert on the subject, this book is 212 pages, softcover, and is published by the Association of Brewers. It is divided into four parts — Background, Process, Ingredients and Recipes. Ship wt. 2 lbs.



## Drink the Harvest— Making and Preserving Juices, Wines, Meads, Teas, and Ciders

**M00425**  
**\$19.50**

Wouldn't you love to taste fresh from the garden or orchard peach juice and pear cider, rose hip tea, watermelon-mint syrup, dandelion wine and mixed berry mead? Skip the sugary commercial drinks and make these and many more fresh delicious beverages in your own kitchen. Whether you're looking for new ways to enjoy your garden's bounty or want to experiment with pure concoctions made from farmers' market finds, these recipes and techniques — including harvesting, canning, fermenting, and pasteurizing — will introduce you to a whole new world of garden goodness. Softcover, 223 pages. Ship wt. 1.25 lbs.



## Making Wild Wines & Meads

**M00039**  
**\$17.45**

125 unusual recipes using herbs, fruits, flowers and more to make a wide variety of wines and meads (honey wines). An excellent book for the home wine and mead maker. Authors Pattie Vargas and Rich Gulling are avid winemakers and will treat you to taste-tempting recipes for delicious fermented drinks such as Lemon-Thyme Metheglin, Cherry Melomel and Cranberry Claret. Softcover, 176 pages. Ship wt. 1 lb.

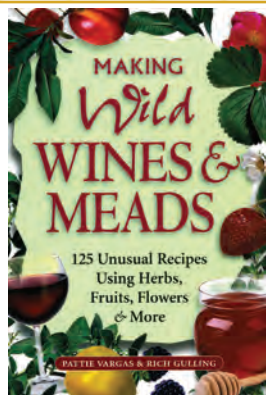

## Make Mead Like a Viking

**M02309**  
**\$25.70**

As a homesteader, fermentation enthusiast, and self-described "Appalachian Yeti Viking" author Jereme Zimmerman embraces the traditional culture and rituals surrounding mead and will help others bring a sense of wildness, mysticism, and individuality to their home-crafted brews. In this accessible, easy-to-follow guide, readers will learn how to brew their own drinks such as sweet, semi-sweet, and dry meads; melomels, metheglins, as well as Ethiopian t'ej, honey beers and grog. Softcover, 214 pages. Ship wt. 2 lbs.



## Making Mead (Honey Wine)

**M00012**  
**\$20.60**

An extremely popular book. Roger A. Morse provides the history and methods of making fermented drinks from honey and honey-fruit mixtures. Judging criteria included. Softcover, 128 pages. Ship wt. 1 lb.

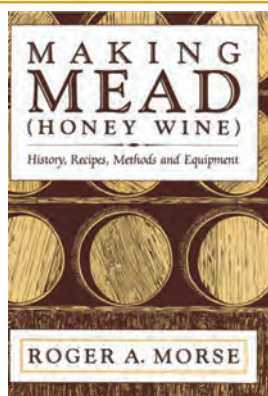

Restocking fee of 35% for all pre-approved book returns

1-888-922-1293

# CREAMED HONEY AND LIP BALM KITS



M00506

## Dadant Creamed Honey Kit

**\*Increase Profits \* Easy to do  
\* Family Fun**

**Creamed Honey Kit**  
*contains the following:*

- 1 - Mixing Bucket with Gate
- 25 - 1 lb. Creamed Honey Containers
- 25 - Creamed Honey Labels
- 1 - Easy to Follow Instructions
- 1 - 1 lb. "STARTER" Seed
- 1 - Stainless Steel Mixer (used with 3/8" drill)
- 2 - 1 dram (1/16 oz.) Peach Flavoring Sample
- 2 - 1 dram (1/16 oz.) Strawberry Flavoring Sample
- 2 - 1 dram (1/16 oz.) Chocolate Flavoring Sample

**M00506** Creamed Honey Kit  
Ship wt. 10 lbs. .... **\$75.95**



M01376 M01375 M01377

M00506-05

## Accessories:

- M00506-02** 25 Labels  
Ship wt. 2 ozs. .... **\$4.00**
- M00203** C/25 1 lb. Containers  
Ship wt. 2 lbs. .... **\$13.05**
- M01330** 1 lb. "STARTER" Seed  
Ship wt. 1 lb. .... **\$4.70**
- M01376** 4 oz. Peach Flavoring Each  
Ship wt. 6 ozs. .... **\$17.45**
- M01377** 4 oz. Strawberry Flavoring Each  
Ship wt. 6 ozs. .... **\$17.45**
- M01375** 4 oz. Chocolate Flavoring Each  
Ship wt. 6 ozs. .... **\$17.45**
- M00506-01** Stainless Steel Mixer with Instructions  
Ship wt. 8 ozs. .... **\$38.55**
- M00506-03** Creamed Honey Instructions  
Ship wt. 1 oz. .... **\$2.65**
- M00506-05** Creamed Honey Shrink Bands c/100  
Ship wt. 4 ozs. .... **\$9.05**



M01930

## Lip Balm Kit

With ingredients such as natural beeswax, almond oil and shea butter you have a spa treatment for the lips. Kit includes 12 pots, 12 tubes, beeswax, 4 oz. almond oil, 4 oz. shea butter, four 1 dram bottles of gourmet flavoring oils (tangerine, pineapple, tropical punch and peppermint), stir sticks, decorative labels and instructions. Makes enough for 24 containers.

**M01930** Lip Balm Kit, Ship wt. 3 lbs. ea. .... **\$29.80**

## Lip Balm Accessories

- (A) **Pots - 12 ct.** — **M019301** — Ship wt. 5 ozs. .... **\$10.25**
- (B) **Tubes - 12 ct.** — **M019302** — Ship wt. 3 ozs. .... **\$10.25**
- (C) **Shea Butter 4 oz.** — **M019303** — Ship wt. 5 ozs. .... **\$7.15**
- (D) **Almond Oil Sweet 4 oz.** — **M019304** — Ship wt. 6 oz. .... **\$6.15**
- (E) **Tangerine Oil - 1 Dram** — **M019305** — Ship wt. 1 oz. .... **\$2.40**
- (F) **Peppermint Oil - 1 Dram** — **M019306** — Ship wt. 1 oz. .... **\$2.40**
- (G) **Pineapple Oil - 1 Dram** — **M019307** — Ship wt. 1 oz. .... **\$2.40**
- (H) **Tropical Punch Oil - 1 Dram** — **M019308** — Ship wt. 1 oz. .... **\$2.40**

**Available at all branch locations**

-- NO SUBSTITUTIONS OR PARTIAL RETURNS ON KITS --

# SOAP MAKING

## Melt & Pour Beginners Kit

Make your own honey glycerine soap! Simply melt our honey based glycerine soap (contains 10% honey), add coloring and fragrance and pour into a mold. Kit includes 5 lb. honey glycerine soap, pouring pitcher, 2 soap fragrances, 2 soap dyes, 2 soap molds, thermometer, and soap making book "Melt & Mold Soap Crafting."

**M04180** Melt & Pour Beginners Kit  
 Ship wt. 9 lbs. .... **\$113.25**



**M04180**

## Standard Beginners Soap Making Kit

Everything you need, except lye, to make your own all natural soap. The kit includes a deluxe digital scale, thermometer, 2 soap molds, coconut, palm and olive oil, 2 soap fragrances, 2 soap dyes, and soap making book "The Soapmaker's Companion book".

**M04182** Standard Beginners Soap Making Kit  
 Ship wt. 13 lbs.. .... **\$124.60**



**M04182**



**M00021**

## The Soapmaker's Companion

Susan Cavitch leads you through every step of the soapmaking process with clear step by step instructions. She includes tips on how to start selling soaps. Softcover, 281 pages. Ship wt. 1lb.

**M00021** ..... **\$19.95**

## Soaper's/ Candlemaker's Scale

This compact digital scale is ideal for soap and candle making. Holds up to 9lbs. with graduation precise to 1g/0.05 oz. and tare function. Ship wt. 3 lbs.

**M04070** ..... **\$38.05**



**M04070**

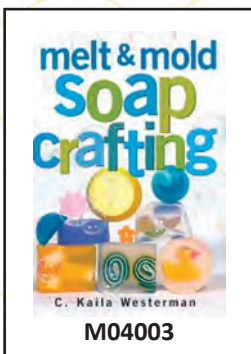

**M04003**

## Melt & Mold Soap Crafting

Soapmaking has never been this easy! The revolutionary melt-and-mold method is taking the craft world by storm. Beginning with a meltable glycerin base, crafters can create stunning specialty soaps in minutes, with no lye and no waiting. It's as easy as melt, pour, mold, and decorate. Softcover, 144 pages. Ship wt. 1 lb.

**M04003** ..... **\$15.40**

## Soap/Candle Thermometer

An essential tool for soap and candle making. Stainless Steel with a shatter-proof plastic lens. Stem inserts into the pocket holder's built in wrench and can be used as a handle.

**M03158** Soap Thermometer  
 Ship wt. 1 lb. ... **\$16.45**



**M03158**

-- NO SUBSTITUTIONS OR PARTIAL RETURNS ON KITS --  
 1-888-922-1293



# SOAP MAKING

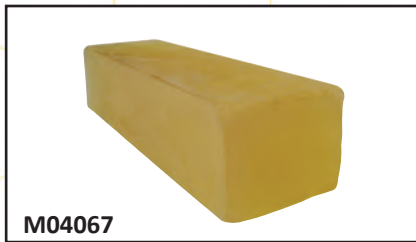

M04067

## Honey Glycerine Melt & Pour Soap

Anyone can become a soap crafter with this 10% honey glycerine soap. Just melt, add fragrance and color and mold. What a great and simple way to extend your product line, please your customers and friends and promote one of the many uses of honey! Comes in a wrapped 5 lb. bar. Ship wt. 6 lbs.

M04067 ..... \$30.85

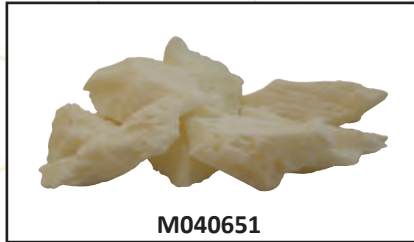

M040651

## Refined Shea Butter

Shea butter helps soften and protect skin from drying and aging. It is a great addition to lotions, balms, salves & soap. Ship wt. 1 lb.

M040651 ..... \$15.40



M040661

## Cocoa Butter

Cocoa butter has a slight chocolate scent. Can be used as a moisturizer. Ship wt. 1 lb.

M040661 ..... \$19.00



M04060

## Soap Making Lye

Lye is getting more difficult to find. This high test lye is ideal for soap making. It comes in a 2 lb. can.

*For pick-up only.*

☒ M04060 ..... \$14.70



M04064QT

## Olive Oil

Olive oil has been used for dry and aging skin for thousands of years. The lather is thick but this is easily remedied by mixing with other oils.

M04064QT Olive Oil - Quart  
Ship wt. 3 lbs. . . \$14.20



M04063GL

M04063QT

## Sweet Almond Oil

Almond oil is used as a main ingredient in massage oils, lotions, salves and balms. In soap it is used in smaller quantities to produce a mild soap with a good lather.

M04063GL Sweet Almond Oil - Gallon  
Ship wt. 8 lbs. . . \$56.60  
M04063QT Sweet Almond Oil - Quart  
Ship wt. 3 lbs. . . \$15.80



M04061GL

M04061QT

## Coconut and Palm-Base Oils

Most recipes call for Palm or Coconut oils. Coconut oil makes a hard bar of soap with a fluffy, creamy lather. Palm oil makes hard long lasting soap with small creamy bubbles.

M04061GL Coconut Oil - Gallon  
Ship wt. 8 lbs. . . . . \$39.60  
M04061QT Coconut Oil - Quart  
Ship wt. 3lbs. . . . . \$10.65  
M04062GL Palm Oil - Gallon  
Ship wt. 8 lbs. . . . . \$33.25  
M04062QT Palm Oil - Quart  
Ship wt. 3 lbs. . . . . \$9.50



M04062QT

M04062GL

# SOAP MAKING

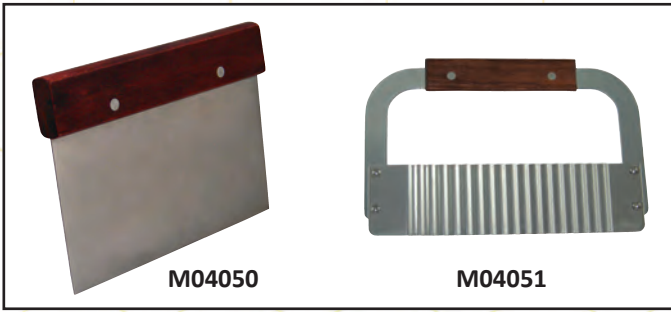

## Soap Cutters

These soap cutters make a simple task of cutting soap into bars.

- M04050** Straight Cutter  
Ship wt. 9 ozs. . . . . **\$12.30**
- M04051** Krinkle Cutter  
Ship wt. 7 ozs. . . . . **\$12.30**



## Wooden Soap Mold

One of the easiest ways to make soap is to use a loaf mold. This wooden mold will produce a loaf that is 3" H x 8" W x 12" L. Simply line the inside of the mold with wax paper or plastic wrap taking care to minimize creases and folds to avoid "blemishes" in the soap. Once the soap has set for 24 hours, unlatch the mold to remove the soap and then let the soap cure for another 24 hours before cutting.

- M04171** Wooden Soap Mold  
Ship wt. 8 lbs. . . . . **\$29.40**



## Liquid Fragrances for Soap

These highly concentrated liquid scents should be added to the soap base before pouring.

- Lavender . . . . . **M0193017**    Vanilla . . . . . **M0193019**
- Rose . . . . . **M0193018**    Cucumber Melon . . . **M0193020**

### Liquid scents 1 oz. bottle

Ship wt. 3 ozs. . . . . **\$6.95**

## Bee and Blossoms Mold

The Bee and Blossom soap mold is a 3 cavity mold. A 3 oz. mold of a worker bee surrounded by many blossoms make this mold very attractive.

- M04155** Bee & Blossoms Mold  
Ship wt. 3 ozs. . **\$11.85**

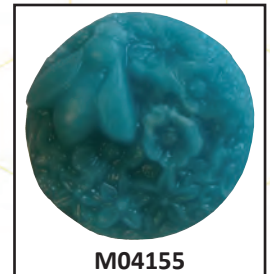

## Flying Bee Mold

The Flying Bee soap mold is a 4 cavity mold. Weighing in at 2.5 oz. this is sure to be a favorite at your local market and sales stand.

- M04156** Flying Bee Mold  
Ship wt. 3 ozs.. **\$11.85**



## Soap Colorant

These are non-toxic liquid soap colorants. A little bit goes a long way.

- Green . . . . . **M03170**    Yellow . . . . . **M03172**
- Blue . . . . . **M03171**    Red . . . . . **M03173**

### Soap Colorant 1 oz. bottle

Ship wt. 3 ozs. . . . . **\$8.45**

## Sunflower Mold

The Sunflower soap mold is a 4 cavity mold. This mold will produce a bar approximately 4 oz. in weight.

- M04157** Sunflower Mold  
Ship wt. 3 ozs. . **\$11.85**

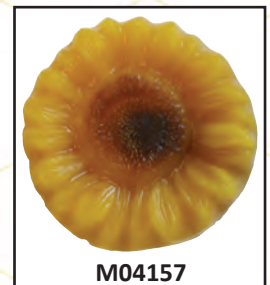

# SOAP MAKING



M04173

## Queen Bee Soap Mold

This 4 cavity mold is sure to please the lady of the house. Design shows a Queen Honey Bee and the words "Queen Bee" are stated on the bar. Sure to be a hit. Great for gifts, farmers markets and in stores. Get yours today. Ship wt. 8 ozs.

**M04173** Soap Bee Mold . . . . \$11.85



M04168

## Guest Tray Rectangular Mold

Welcome guests with small rectangular guest soaps. The mold produces 15 bars of about 1½ oz. each.

**M04168** Guest Tray Rectangular Mold  
Ship wt. 8 ozs. . . . . \$11.85



M04167

## "Handmade" Tray Mold

A great way to advertise your efforts with this "Handmade" mold. The mold produces 8 bars about 4 oz. each.

**M04167** "Handmade" Tray Mold  
Ship wt. 8 ozs. . . . . \$11.85



M04169

## Goat Milk Tray Mold

This tray mold enables you to make 8 bars about 3 oz. each.

**M04169** Goat Milk Tray Mold  
Ship wt. 8 ozs. . . . . \$11.85



M04158

## Guest Bee Soap Mold

Pamper your guests with beautiful soap made from this mold. This 5 cavity mold features a bee surrounded by an attractive border. Each bar weighs about 1¾ oz. and measures 2¼" diameter and ¾" thick.

**M04158** Guest Bee Soap Mold  
Ship wt. 8 ozs. . . . . \$11.85



M04154

## Skep Mold

This is a beautiful 3 cavity skep mold. Each bar of soap weighs approximately 4¾ oz. and measures 3¼" x 2¾" x 1½".

**M04154** Skep Mold  
Ship wt. 8 ozs. . . . . \$11.85



M04159

## Queen Bee Tray Soap Mold

A great mold for honey soap. The bee is located in the center of the mold with a beautiful floral border. The mold produces 9 bars weighing about 4 oz. each.

**M04159** Queen Bee Tray Soap Mold  
Ship wt. 8 ozs. . . . . \$11.85



M04164

## Beehive Tray Soap Mold

The mold produces one 2 lb. block of beehive soap. Simply cut into desired size to impress your guests and friends.

**M04164** Beehive Tray Soap Mold  
Ship wt. 8 ozs. . . . . \$11.85



M04152

## Bee and Flower Mold

This 4 cavity mold shows a bee landing on a flower. Each bar weights about 4 ozs.

**M04152** Bee and Flower Mold  
Ship wt. 8 ozs. . . . . \$11.85



M04153

## Bee & Honeycomb Mold

If you produce honey and beeswax soap this mold is for you. This is a 4 cavity mold showing a bee walking across a honeycomb. Each bar weighs approximately 3½ oz.

**M04153** Bee & Honeycomb Mold  
Ship wt. 8 ozs. . . . . \$11.85



M04165

## Pine Cone Tray Mold

This popular 6 cavity mold will please friends and customers alike. Pine cone and needles are shown in great detail. Each bar weighs approximately 4 ozs.

**M04165** Pine Cone Tray Mold  
Ship wt. 8 ozs. . . . . \$11.85

# CANDLE MAKING



M03200

## Candlemaker Beginner's Kit

Here is all you need to begin making your own candles. The kit includes an aluminum melting and pouring pot, the book "Basic Candle Making", 3 lbs. ivory beeswax, 6 cup metal votive mold, 100 metal tea light cups, 100 pre-assembled votive light wicks, 100 pre-assembled tea light wicks, thermometer, 1 can of mold release spray and 1 bottle of wax remover.

**M03200** Candlemaker Beginner's Kit  
Ship wt. 18 lbs. . . . . **\$124.60**

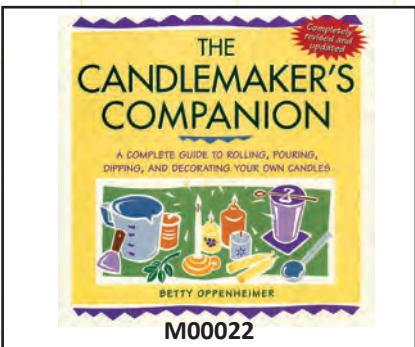

M00022

## The Candlemaker's Companion

From wax to wick to wrapping, the magical glow of a handmade candle is now easier to create than ever before. Illustrated step by step instructions show you how to roll, pour, mold and dip candles. A great book for beginners and experienced candlemakers. Softcover, 199 pages. Ship wt. 2 lbs.

**M00022** . . . . . **\$21.60**

### How to Make Spiral Candles

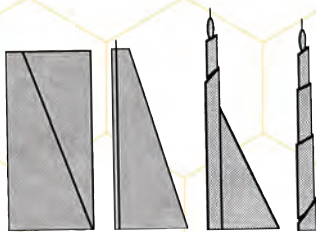

1. Cut sheet on the bias, making cut 2 inches from the corner of the sheet.
2. Lay 2/0 wick on straight edge of sheet and crimp edge of sheet over it.
3. With fingers spread over length of candle, start to roll wax making sure you roll tightly while keeping bottom end of candle even.



M03001

## Basic Candle Making

This is a wonderful instructional book. Author Scott Ham gives detailed step by step instructions with full color photographs to show how to craft molded, tapered, container and rolled beeswax candles. Softcover, 104 pages, spiral bound. Ship wt. 1 lb.

**M03001** . . . . . **\$20.55**

*See page 135  
for Beeswax Honeycomb  
Sheets and Candle Wicking*

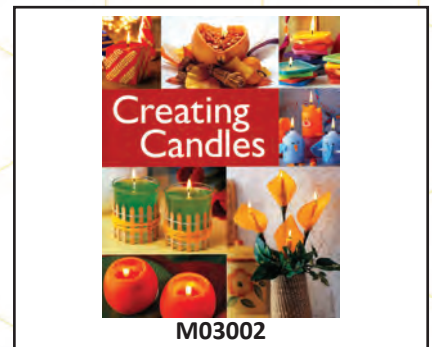

M03002

## Creating Candles

With over a hundred unique projects and more than a thousand beautiful photographs this book is a must have guide for candle makers. Precise instructions accompany each photo. From designing a candle for special occasions to simply adding a decorative touch to any table, this book offers ideas using a wide variety of materials. It also includes creative variations and gift wrap suggestions for each candle. Softcover, 223 pages. Ship wt. 1 lb.

**M03002** . . . . . **\$27.75**

### How to Make Pillar Candles

1. Use full sheet, place #2 wick across narrow end. Crimp edges to secure the wick.
2. Roll tightly, keeping the edges even
3. Finished candle

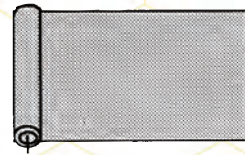

-- NO SUBSTITUTIONS OR PARTIAL RETURNS ON KITS --

1-888-922-1293

# CANDLE MAKING

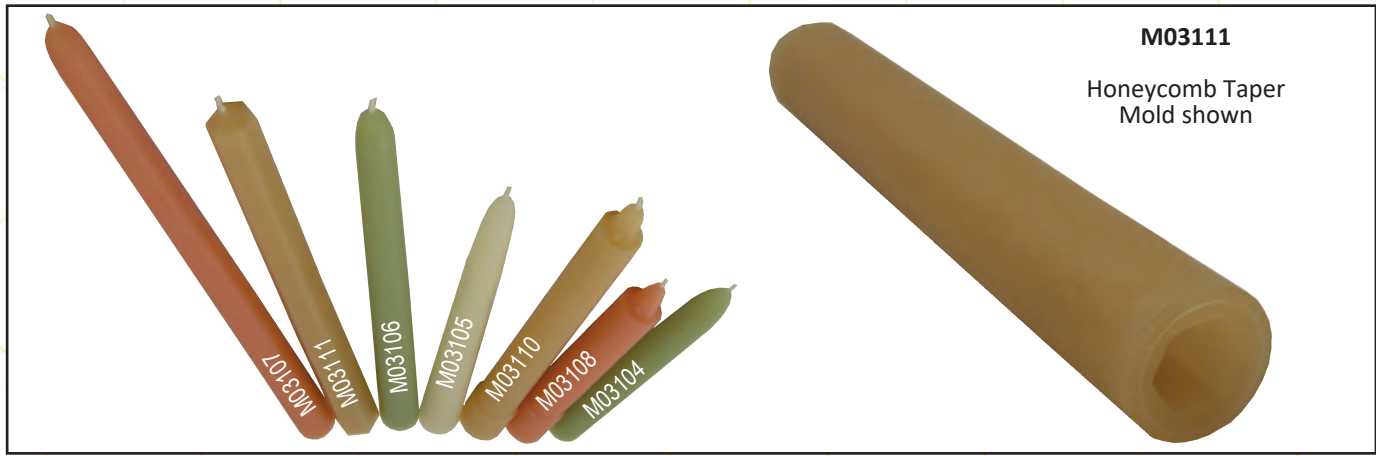

## Polyurethane Taper Molds

Make professional quality candles with these molds. A pre-formed hole at the tip of each mold can be wicked with our wicking needle (*not included*). These molds are self-wicking. Simply pull the finished candle out and you pull up a new wick. No seams or trimming necessary. Self-sealing base. No need for sealer around the wick.

### 6" TAPER MOLD

- M03104 Standard** Ship wt. 6 ozs. . . . \$28.25
- M03108 Colonial** Ship wt. 6 ozs. . . . \$28.25

### 8" TAPER MOLD

- M03105 Standard** Ship wt. 8 ozs. . . . \$30.85
- M03110 Colonial** Ship wt. 8 ozs. . . . \$30.85

### 10" TAPER MOLD

- M03106 Standard** Ship wt. 9 ozs. . . . \$32.80
- M03111 Honeycomb** Ship wt. 9 ozs. . . . \$32.80

### 12" TAPER MOLD

- M03107 Standard** Ship wt. 10 ozs. . . . \$35.05



M03159

### Wick Needle

This 18" copper wick needle makes threading the wick a snap. For use with polyurethane taper molds. Ship wt. 2 ozs.

**M03159** Wick Needle . . . . . \$7.65



M03113

### Fluted Base Former

For a professional look, the fluted base former aids in getting a snug fit in a candle holder. Made of cast aluminum. Ship wt. 2 lbs.

**M03113** . . . . . \$56.60



**M03121**  
3" x 6½" Pillar

**M03120**  
2" x 3½" Pillar

## Pillar Molds

These aluminum molds are ideal for beeswax pillars. Use the bar listed below to center the wick. (*wick bar and wick sold separately*)

**M03120** 2" x 3½" Pillar Mold  
Ship wt. 2 ozs. . . . . \$11.85

**M03121** 3" x 6½" Pillar Mold  
Ship wt. 5 ozs. . . . . \$15.45

**M03114** Wick Bar  
Ship wt. 1 oz. . . . . \$3.30



M03114

(*mold, wick bar and wick all sold separately*)

# CANDLE MAKING

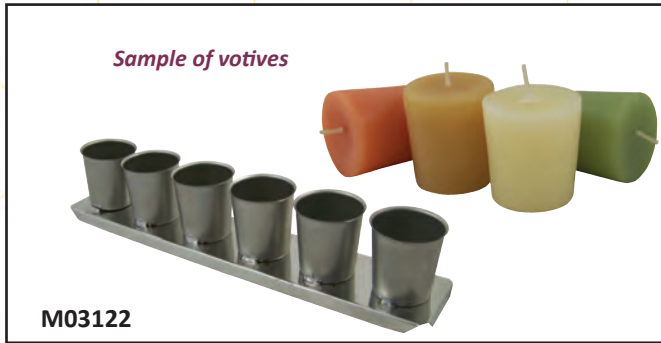

Sample of votives

M03122

## Aluminum Votive Mold

This six cavity votive light mold will make an unlimited number of 15 hour votive candles. Spray silicone mold release prior to filling. For quicker release, place in freezer. Ship wt. 1 lb.

M03122 ..... \$22.55

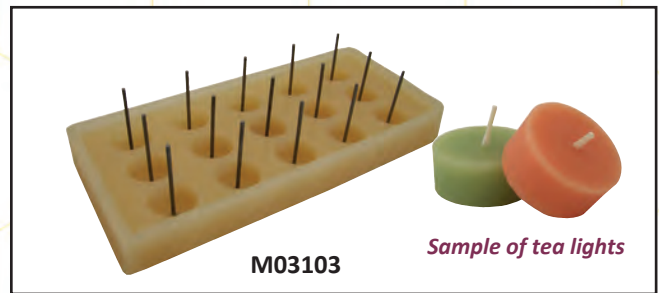

M03103

Sample of tea lights

## Tea Light Mold

This mold makes 15 tea lights with a center hole. Just slip a pre-assembled wick into the candle and place in a tea light cup. See M03102 for votive wicks and M03101 tea light wicks. Ship wt. 3 lbs.

M03103 ..... \$67.95

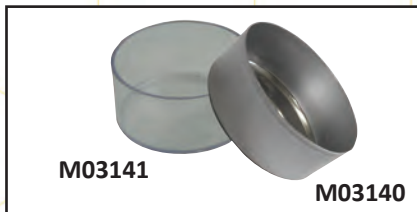

M03141

M03140

## Tea Light Cups

These cups hold a ½ oz. of beeswax. Use plastic (polycarbonate) in open containers and metal in closed containers where generated heat might melt plastic. Ship wt. 1 lb.

M03140 metal, c/100. .... \$15.40

M03141 plastic, c/100. .... \$16.50



M03112

## Beeswax Cake Mold

Create your own beautiful 1 lb. beeswax cakes with "Beeswax" embossed on each cake. Made of polyurethane. Very flexible and long lasting. Ship wt. 2 lbs.

M03112 ..... \$38.05



M03100

## Seamless Melting Pot

This aluminum melting pot holds approximately two quarts of wax. It is ideal for filling candle and soap molds. Use with a water bath and never put on direct heat. Ship wt. 2 lbs.

M03100 ..... \$24.65

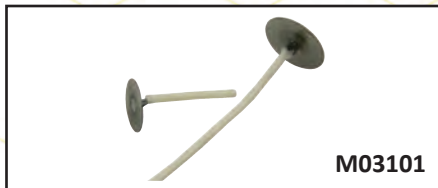

M03101

## Pre-assembled Wicks

Save time with these pre-assembled wicks. Metal tab keeps wick upright while pouring wax.

M03101 Tea Light Wicks (qty. 100)  
Ship wt. 1 lb. .... \$7.90

M03102 Votive Light Wicks (qty. 100)  
Ship wt. 1 lb. .... \$7.90



M03130

## Candle Mold Cleaner

Over time molds accumulate debris and blemishes. Use this to restore mold to like-new condition. Regular mold cleaning extends the mold life. Contains petroleum distillates. Use with proper ventilation. Works on most molds. Test a spot if you are unsure. 16 oz. container. Ship wt. 1 lb.

M03130 ..... \$15.35



M03158

## Soap/Candle Thermometer

An essential tool for soap and candle making. Stainless Steel with a shatter-proof plastic lens. Stem inserts into the pocket holder's built-in wrench and can be used as a handle. Ship wt. 1 lb.

M03158 ..... \$18.10



M03050

## Silicone Release Spray

Treating your mold before use will ensure that the details of the candle come out intact and are not lost by bits of wax sticking to the mold. 12 oz. container.

M03050 Silicone Release Spray  
Ship wt. 1 lb. .... \$12.95



M03123

## Candle Dipping Rack and Vat

Simply fill the vat with melted wax and the dipper will allow you to make three pairs of dipped candles at a time. Vat holds up to 11½ lbs. of melted wax. Instructions available upon request.

**Do Not Heat Wax in Dipping Vat.**

M03123 Dipping Rack  
Ship wt. 2 lbs. .... \$29.65

M03124 Dipping Vat 6" x 15"  
Ship wt. 3 lbs. .... \$41.55



M03124  
6" dia. x 15" high

# BEESWAX HONEY COMB SHEETS

Create Your Own Candles!



- A Great Hobby
- Use Your Creative Talents
- A Great Money Maker
- Perfect for Fund-Raising

Note: Colors shown may not be an accurate sample of the color due to the difference in the beeswax used.

Sheet Size:  
8" x 16<sup>3</sup>/<sub>4</sub>"  
Approx. 8  
sheets per lb.

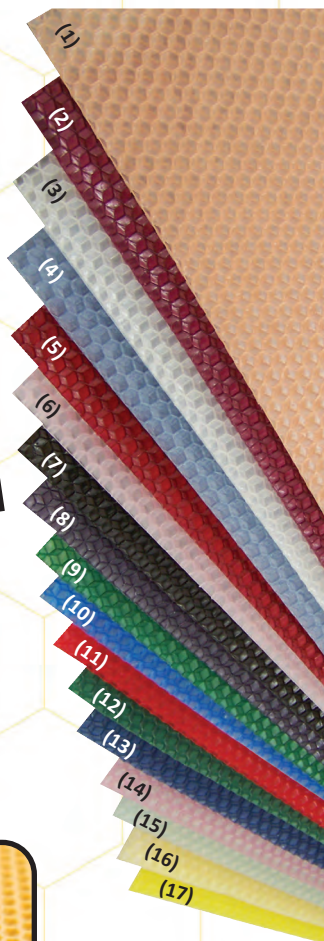

## 17 Beautiful Colors

| Sheet Color         | 10 sheets | 100 sheets |
|---------------------|-----------|------------|
| Apricot (1)         | M43710    | M43700     |
| Burgundy (2)        | M42410    | M42400     |
| Classic Ivory (3)   | M40310    | M40300     |
| Cornflower Blue (4) | M43110    | M43100     |
| Cranberry (5)       | M41610    | M41600     |
| Dusty Pink (6)      | M43610    | M43600     |
| Ebony (7)           | M43410    | M43400     |
| Egg Plant (8)       | M41710    | M41700     |
| Forest Green (9)    | M41410    | M41400     |
| French Blue (10)    | M41010    | M41000     |
| Holiday Red (11)    | M41210    | M41200     |
| Hunter Green (12)   | M41310    | M41300     |
| Indigo (13)         | M41910    | M41900     |
| Mauve (14)          | M41810    | M41800     |
| Mint (15)           | M44610    | M44600     |
| Natural (16)        | M40110    | M40100     |
| Sunflower (17)      | M40210    | M40200     |

|                 |                  |
|-----------------|------------------|
| Ctn/10 Sheets   | Ctn/100 Sheets   |
| <b>\$23.75</b>  | <b>\$203.90</b>  |
| Ship wt. 2 lbs. | Ship wt. 16 lbs. |

### Candle Wicking

High quality 100% cotton wicking for all your candle needs. Wick sizes are for beeswax only. Packed in 30 ft. lengths. Ship wt. 1 lb.

|  |   |
|--|---|
| <b>#2 Wicking</b><br>— M03180 —<br><i>best used on<br/>Beeswax Tapers</i><br><b>\$4.50</b>                         | <b>1/0 Square Braid</b><br>— M03181 —<br><i>best used on<br/>Rolled Candles<br/>over 1" Wide</i><br><b>\$4.50</b> |
| <b>2/0 Square Braid</b><br>— M03182 —<br><i>best used on<br/>Rolled Candles<br/>under 1" Wide</i><br><b>\$4.50</b> | <b>60 Ply</b><br>— M03183 —<br><i>best used on<br/>Pillars 3" and over</i><br><b>\$4.50</b>                       |

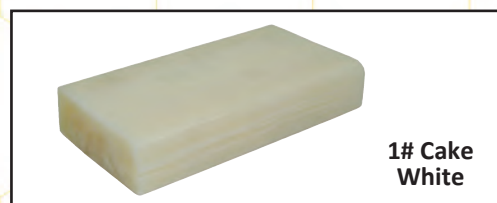

### Beeswax

Our white beeswax is selected from fine cappings wax and pressure filtered to produce a beautiful ivory color with the familiar beeswax scent. Our yellow refined beeswax varies in color from orange yellow to light brown. It has been filtered to remove impurities. Neither wax contains bleach.

|               |                               |               |
|---------------|-------------------------------|---------------|
|               | <b>Yellow Refined Beeswax</b> |               |
| <b>W00102</b> | 1# Cake Ship wt. 2 lbs. ....  | <b>\$9.65</b> |
|               | <b>White Refined Beeswax</b>  |               |
| <b>W00202</b> | 1# Cake Ship wt. 2 lbs. ....  | <b>\$9.65</b> |

Call for Quantity Breaks  
www.dadant.com

# GREAT IDEAS FOR GIFTS

## HONEY SIGNS



### Plastic Corrugated Honey Sign

Durable waterproof sign to sell your honey. Black text on orange. Sign measures 18" x 24".

**M00791** Ship wt. 2 lbs. ea.  
\$10.15



### Plastic Corrugated Caution Sign

Durable waterproof sign to help keep unwanted guests away. Sign measures 18" x 24".

**M01962** Ship wt. 2 lbs. ea.  
\$10.25



### Metal Honey Sign

Attract people to your honey. Black text on bright yellow 18" x 24" *Local HONEY For Sale* sign.

**M01963** Ship wt. 4 lbs. ea.  
\$34.95



### Metal Stand

Display Plastic Corrugated Honey Signs in your yard. Stake can be inserted into the ground up to 8" to display your sign at a minimum height of 12" (from ground to bottom of sign).

**M01968** Ship wt. 2 lbs. ea.  
..... \$11.30

*Only for use with plastic corrugated honey signs.*

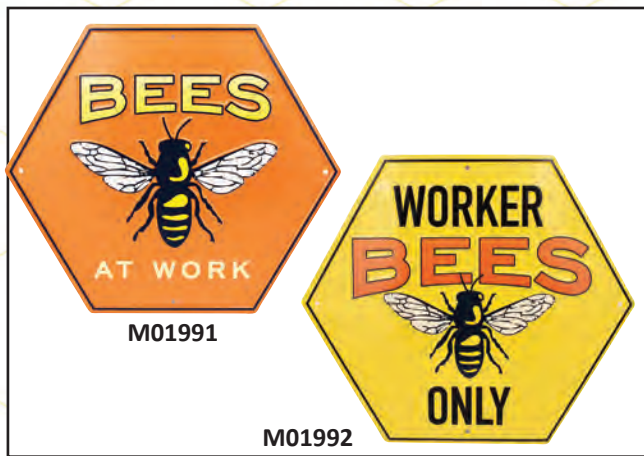

**M01991**

**M01992**

### Hexagon Worker Bee Signs

Our hexagon worker bee signs are sure to please any honeybee enthusiast. 14" wide x 12.25" tall. Post them in your extracting room or bee yard and let those around you know worker bees are in the area.

**M01991** Bees at Work,  
Ship wt. 2 lbs. ea. .... \$22.60

**M01992** Worker Bees Only,  
Ship wt. 2 lbs. ea. .... \$22.60



**M01960**



**M01961**

### Metal Street Signs

Our Beeman Blvd and Queens Hwy signs are made like an official street sign. Can be displayed inside or out. Dimensions are 6" x 24".

**M01960** Beeman Blvd, Ship wt. 2 lbs. ea. .... \$22.60

**M01961** Queens Hwy, Ship wt. 2 lbs. ea. .... \$22.60



# GREAT IDEAS FOR GIFTS

## WINE MAKING & GIFT BAGS

FOR ALL YOUR WINE and MEAD MAKING NEEDS PLEASE VISIT OUR WEBSITE AT:  
<https://www.dadant.com/catalog/crafts/wine-mead-making>



M01407

### Mead Making Kit

This one gallon mead making kit has all the equipment you need to make a great honey wine. Kit comes with one gallon carboy, double bubble air lock, rubber bung, funnel, racking hose, yeast energizer, wine yeast and instructions. This kit would make a great gift for your favorite mead loving beekeeper.

M01407 ..... \$51.00

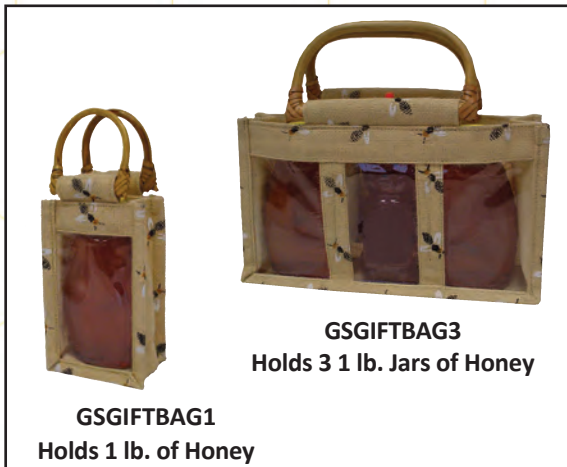

GSGIFTBAG1

Holds 1 lb. of Honey

GSGIFTBAG3

Holds 3 1 lb. Jars of Honey

### Gift Bags

Proudly display your honey in these honey bee designed gift bags. Made from jute with a clear display window and honey bee designs. Choose either the single or triple, designed to hold either one or three 1 lb. Queenline style or Classic jars.

GSGIFTBAG1 Ship wt. 2 ozs. .... \$3.55 ea.

GSGIFTBAG3 Ship wt. 5 ozs. .... \$4.50 ea.

CALL FOR QUANTITY PRICING



Honey Not Included

GS050

### Honey Box

This honeybee decorated box holds 3 – 1 lb. jars of honey (honey not included). Show off your spring, summer, and fall honey in this nice corrugated box. Makes for a great gift and perfect for farmers markets. Ship wt. 8 ozs.

GS050 Honey Box ..... \$3.80

# GREAT IDEAS FOR GIFTS



M01170

## Honey Bee Pancake Pan

Make breakfast extra special with whimsical, honey bee-motif pancakes that honor this humble, hardworking and highly revered pollinator. Each of the 7 pancakes will have a sweet, detailed image browned into it of a honeycomb, flower, hive or busy bee. Crafted of cast aluminum in the USA this sturdy pan features a stay cool handle plus PFOA-free nonstick to make turning pancakes and cleaning a breeze. Works with mixes or any favorite pancake recipe. 17¼" x 16" x 2¼"

M01170 Honey Bee Pancake Pan, Ship wt. 2 lbs. ea. . . . . \$46.40



M01160

## Bee Hive Cake Pan

Our decorative cake pan does the work of hundreds of buzzing bees – with incredibly sweet results. Just fill both sides with batter, then bake. Adorned with bees, the two halves emerge ready to be pressed together with icing and decorated to form the 7" diam., 6" high cake. The cast-aluminum pan's nonstick finish ensures easy release. Hand-wash. 16" x 7¼" x 3½" high.

M01160 Bee Hive Cake Pan, Ship wt. 3 lbs. ea. . . . . \$46.30



M01161

## Beehive Cakelet Pan

- Cast Aluminum
- Interior Dimensions: 3 cups 2.78"L x 2.68"W x 2"H/ cavity
- Lifetime Warranty by manufacturer
- Made in America
- Hand wash

M01161 Beehive Cakelet Pan, Ship wt. 3 lbs. ea. . . . . \$46.30



M01162

## Honey Bees Cookie Stamps

- Cast Aluminum with Wooden Handles
- Makes 3 different styles - 3" Round Cookies
- Limited Lifetime Warranty by manufacturer
- Made in America
- Hand wash

M01162 Honey Bees Cookie Stamps, Ship wt. 3 lbs. ea. . . . . \$46.30



M01261

## Honeycomb Cake Pan

Our exclusive heavy cast aluminum Bundt Bakeware provides superior baking performance. Baked goods rise evenly, cook uniformly, and are finely detailed thanks to the excellent thermal conduction of the heavy walls. A special heat-reflective exterior and premium nonstick surface assures perfect results. Our unique pans are wonderful for bread, molded desserts and savory dishes, as well as cake. Hand wash. 12¼" x 11¾" x 2¼"

M01261 Honeycomb Cake pan, Ship wt. 3 lbs. ea. . . . . \$46.30



GSBQSAUCE  
Louisiana style

## BBQ Sauce Sue Bee Honey

Sue Bee has done it again. They have created another premium barbeque sauce using pure natural honey as the main ingredient. With two exciting flavors, Original Premium and Louisiana Style, you will want to buy both. Each bottle is 18 ozs. (Ship wt. 2 lbs.)

GSBQSAUCE Original Premium. . . . . \$4.50 ea.

GSBQSAUCE Louisiana Style . . . . . \$4.50 ea.



M02205LB

## Honey Candy An Old Fashioned Favorite

Back and better than ever. This old fashioned honey-filled goodness is again available in a variety of assorted flavors. Enjoy lemon, strawberry, orange, sour apple, grape or double honey candies. All individually wrapped for easy handling. Approx. 72 pieces per pound. Ship wt. add 1 lb. to quantity ordered.

M02205LB . . . Assorted . . . . M02205CS  
Approx. 72 pieces per lb. - 29 lbs. per case

\$6.15 per lb.

1-9 cases: \$102.95 per case  
10 & Up: \$96.75 per case

# GREAT IDEAS FOR GIFTS

## Bee Key-pers

These keychains are perfect for the beekeeper or gardener in your family. Also works great on luggage when trying to identify one's suitcase at the airport.



- M01708
- M01710
- M01711
- M01709
- M01713

- M01708 Large bees/blue trim
- M01710 Black trim
- M01711 Gold trim
- M01709 Hot Pink
- M01713 Pink flowers/gold trim
- M01714 Medium bees/green trim
- M01715 Tiny bees/blue trim
- M01716 Polka dot/black trim
- M01717 Honey pots/orange trim
- M01718 Honey pots/green trim

**\$10.25 ea.**

Ship wt. 1 oz.



- M01714
- M01715
- M01716
- M01717
- M01718

## Dog Collars / Leashes



These Honey Bee collars and leashes are perfect for your beekeepers best friend. They are sure to have all of your friends asking where they can get one for their dogs and cats. Available in 3 sizes small 10"-15" collar, medium 12"-18", and large 15"-24". Leashes that match the collar are available or mix and match as you'd like. Check [www.dadant.com/catalog](http://www.dadant.com/catalog) for additional designs not listed in our paper catalog.

**COLLARS — \$19.05 each**  
 Small - 10" - 15"  
 Medium - 12" - 18"  
 Large - 15" - 24"

**LEASHES — \$19.05 each**  
 70"



For more pattern options please visit [www.dadant.com/catalog](http://www.dadant.com/catalog)

Some small sizes also available online

**NOT ALL COLLARS COME IN ALL SIZES**

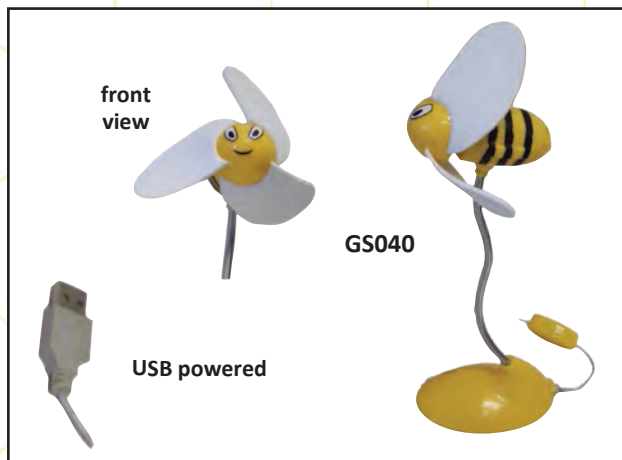

front view

GS040

USB powered

### Bee Fan

This cute honeybee desk fan will keep you cool while working at the computer. Comes with soft flexible blades and plugs directly into the USB port of your computer's hard drive. Ship wt. 5 ozs.

GS040 ..... \$15.80

### Old Beekeeper Craft

Perfect gift for your beekeepers desk or shelf. The Old Beekeeper Craft will look great where ever you put it. Ship wt. 1 lb. ea.

M01279 ..... \$6.75



M01279

### Honey Bee Tree Game

The Honey Bee Tree Game is a skill and action game for ages 3 and up. Skillfully remove the leaves without waking the bees. 2-4 players. Ship wt. 3 lbs.

GSBETREE ... \$20.55



GSBETREE

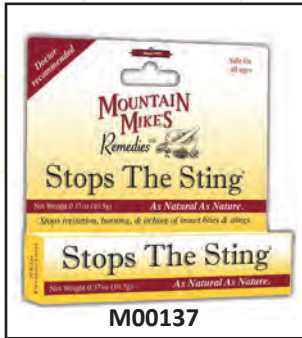

### Stops the Sting

"Stops the Sting" does just that. If you have been stung, smear a small amount of "Stops the Sting" on the affected area for aid in relief of the pain. Ship wt. 1 lb., ea.

**M00137** ..... \$9.00



### Apis M. Magnet

Show your support for the honey bee with this Apis M magnet. Perfect for your refrigerator, or car bumper. Ship wt. 0.8 ozs. **GS014**..... \$3.90



### Jet Force — Bee, Wasp & Hornet Killer

Jet Force is great for getting rid of those unwanted pests. (Not for use around honey bees.) Provides a 12 ft. jet stream of insecticide that kills bees, wasps, yellow jackets, and hornets. Kills at once on contact and residue kills within 24 hours. Ship wt. 2 lb. ea.

**M001431** ..... \$11.05  
12 & up ..... \$10.20



**GSDECALS**

### Family Beekeepers Decal

Show off your status as a beekeeper as you drive around town, apply them to your beekeeping binder or decorate your apiary office with these durable vinyl beekeeper family decals. Ship wt. 1 oz.

**GSDECALS** ..... \$16.95



**Assembled**

**TOOLS and  
FRAMES NOT  
INCLUDED**

**M01977**

### Multi-Purpose Tool Box

This multi-purpose tool box will carry most everything you need to take to the bee yard. Carry extra frames, pollen sub patties, tools and medications. This box can come in handy on swarm calls as well. Uses 9 1/8" frames - **not included**.

**M01977** Tool Box, Ship wt. 13 lbs. .... \$77.20



**Assembled**

**FRAMES NOT  
INCLUDED**

**GS4006**

### 5-Frame Observation Hive

This 5-frame nuc observation hive is perfect for educating both adults and children alike. Pull a frame from the nuc and place in the observation hive. Be sure to find the queen and place her in the upper section. The removed frame can be replaced with a division board feeder full of sugar syrup to feed the bees while caged. When not using the observation window move the frame back down below and let the bees fly freely until needed again. Uses 9 1/8" frames - **not included**.

**GS4006** 5-Frame Observation Hive  
Ship wt. 18 lbs. .... \$192.55



**B52901**

entrance

**Assembled**

### Top Bar Hive

For the natural beekeepers here is the ultimate in top bar hive. This top bar hive comes with 26 frames that can be divided into two separate hives with the follower board and screened bottom. Comes fully assembled except for the legs.

**Ships freight.**

- Fully assembled except for the legs
- Screened bottom board
- Follower board
- 26 top bars

**B52901** Top bar hive, Ship wt. 55 lbs\*. .... \$291.70

\* See page 144

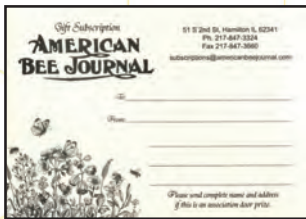

**Gift Subscription Card**

Call or Fax for Airmail Rates — Rates are also available online at

[www.americanbeejournal.com](http://www.americanbeejournal.com)

**Dadant**  
FAMILY OWNED SINCE 1863

**GIFT CARDS**  
The perfect gift for anyone!

Redeemable at all branch locations and online at [www.dadant.com/catalog](http://www.dadant.com/catalog)



**Dadant Gift Certificate**

Dadant Gift Certificates can be purchased for your last minute shopping. Order today for any dollar amount with a Discover, Master Card, Visa and American Express and a certificate is mailed to the recipient.

*Available at Hamilton, IL location only.*  
Redeemable at all 11 Dadant Branch Locations!

**Dadant Hats - Assorted Colors \$10.25 each**

Embroidered hat with adjustable strap. Available in 15 color combinations. Ship wt. 3 ozs.



**M012122**  
Cardinal Red/White



**M012123**  
Charcoal Gray/Black



**M012124**  
Charcoal Gray/  
Columbia Blue



**M012125**  
Charcoal Gray/  
Neon Green



**M012126**  
Charcoal Gray/  
Neon Orange



**M012127**  
Charcoal Gray/  
Neon Pink



**M012128**  
Heather Gray/Black



**M012121**  
Brown/  
Khaki Beige



**M012129**  
Heather Gray/Navy



**M012110**  
Heather Gray/  
Royal Blue



**M0121211**  
Khaki Beige/  
Burgundy Red



**M0121212**  
Maroon Red/  
White



**M0121213**  
Navy Blue/  
Orange



**M0121214**  
Red/Black



**M0121215**  
Royal Blue/White

[www.dadant.com](http://www.dadant.com)

# CLEARANCE ITEMS - LIMITED QUANTITIES

## AP23 MICROBIALS

M00158 1 hive treatment,  
Ship wt. 7.6 ozs. ....\$5.95  
M00159 10 hive treatment,  
Ship wt. 4.4 lbs..... \$54.95

## BROOD DFM

M01890 1 hive treatment,  
Ship wt. 0.5 ozs. ....\$5.95  
M01894 100 hive treatment,  
Ship wt. 2.5 lbs.....\$127.95



M00785

M00780

M00780 Bee Blower \$633.55  
M00781 10' Replacement Hose. \$33.30  
M00782 Replacement Nozzle \$7.75  
M00785 Collapsible Chute. \$82.45

Screened Bottom Board  
with West Beetle Trap Insert



B92901W  
\$34.25



Bee Key-pers

M01712 Pink Trim  
\$10.25



Ventilated Goatskin Gloves

M011392XL – XX-Large  
\$17.95



Insect  
Pollination  
of Cultivated  
Crop Plants

M00110  
\$36.00



Bees —  
An Up-close  
Look at  
Pollinators  
Around the  
World

M00424  
\$25.75

CLEARANCE

# COMPANY POLICY

## FREE SHIPPING

Free Shipping applies to most orders placed from this catalog and our online store for orders over \$100 prior to tax and other handling charges. Items will be sent regular ground by the carrier of our choice within the lower 48 states. Items marked with the symbol  are excluded from the free shipping offer. The items included/excluded from free shipping are subject to change without notice. Due to rising cost for shipping, back-orders are shipped and billed separately from your original order. Customers will be responsible for the additional shipping charges on all back orders. If you wish to have your order held for the back ordered item please put that in the notes section online or advise the customer service rep when phoning in an order. AK and HI are excluded.

## SHIPPING RATES

Customer pays all freight cost unless otherwise stated or agreed upon. Large orders over 200 lbs will be reviewed to determine if the order will go regular ground or by freight. If we determine the order is too large to go by ground, we will compare different freight lines to get the best possible rate for you. Next day, 2-day, & 3-day shipments will be available at expedited rates. Freight is F.O.B Shipping point meaning customer take full responsibility upon leaving Dadant & Sons Shipping Point.

## ADDITIONAL CHARGES

Rural Area: \$2.75 - Extended Residential: \$3.50 - Address Corrections: \$14.00

Delivery Acknowledgement: \$3.00 - Call Tag Required: \$9.00 - Handling Fee per shipment: \$2.00

\*\*Shipping rates may increase at any time due to rising shipping cost and surcharges\*\*

## EXPORT ORDERS

Orders for export may include shipping, special packaging and documentation fees at the customer's expense. We accept Visa, MasterCard, Discover, American Express & checks drawn from a US Bank in US currency. For large container orders, we accept a bank wire transfer to our bank account or a letter of credit. All bank wire transfer cost and exchange rates are the responsibility of the customer.

## PAYMENT METHODS

We accept Visa, MasterCard, Discover, American Express, check drawn on US bank account, wire transfer, money order & cash.

## OVERPAYMENTS

May be refunded or credited to customers account.

## RETURNED CHECK:

All returned checks will have a \$25.00 service fee

## PICKUP ORDERS

All pickup orders can be picked up at the local branch where the order was placed at. Pickup times can vary by branch. In most cases, if you contact your local branch ahead of time, we will have your order ready for pickup when you arrive.

## BACKORDERS

Backorders are shipped & billed separately from original order. Customers will be responsible for the additional charges on all back orders. Back orders can be dropped from original order at customer's request.

## SPECIAL ORDERS

A 50% deposit must accompany all special orders. Some special orders may be subject to a cancellation charge. Remaining balance due prior to shipping.

## WARRANTY

Dadant & Sons warrants its equipment to be free of defects in material and workmanship. If within 30 days of purchase you feel an item to be defective, please call for return authorization # and shipment instructions for the return. We will refund your purchase price along with all transportation charges. This warranty does not cover any

damage to equipment arising from alteration, abuse, or use of product for other than its intended purpose. We reject all implied and expressed warranties.

## LIABILITY

Because conditions of use are beyond our control, we make no warranty or representation, express or implied, except that all products conform to the description provided by the manufacturer on sales literature or product labels. Our liability is limited to the purchase price paid. Glass containers ship at your own risk.

## PRODUCT SUITABILITY

Many States & localities have codes and regulations governing sales, construction, installation, and or use of products for certain purposes. While we attempt to assure that our products comply with such codes, we cannot guarantee compliance in every situation. We cannot be responsible for how the product is installed or used. Before you purchase and use a product, please review both the product application and local codes and regulations. Be sure that the product, its installation, and its use will comply with them.

## DAMAGED FREIGHT

All merchandise is shipped "F.O.B. Shipping Point". All products become your responsibility as soon as it leaves Dadant & Sons Inc. The freight carrier is responsible for complete and safe delivery or your merchandise. Inspect the packaging and merchandise upon arrival. If the freight carrier fails to deliver your merchandise in good condition, it is your responsibility to note this to the driver upon delivery. Also contact us immediately so we can make a claim with the carrier on your behalf.

## ORDER DISCREPANCIES

Check all orders immediately upon receipt and contact us within 7 business days on any discrepancies/damage or we cannot be responsible for errors.

## RETURNED MERCHANDISE

If you want to return an item, please call 1-888-922-1293 or contact the local branch where the item was purchased from. 1) Item must be in original carton and in good condition, 2) Returned within 30 days of receipt. 3) Must be returned to location of original purchase. 4) Original receipt required. 5) Charges will be applied to the unit reshipped to you with credit applied back to your method of payment upon receipt of original item.

## LIMITATIONS

1) In most cases a 15% restocking fee will be charged. 2) To insure purity, we cannot exchange or offer refunds on beeswax or beeswax foundation. 3) We cannot accept returns on medications, containers, or bee feeds. 4) Restocking fee of 35% for all pre-approved book returns. Exception: If we made an error, we will give a full refund and pay the freight both ways.

## STATE SALES TAX

We are required to collect sales tax where applicable by law. We charge sales tax in the following states.

## HOLIDAY CLOSING

In addition to recognized national holidays, we will be closed the day after Thanksgiving.

## CLOSING FOR INVENTORY

We will be closed on August 30 & 31, 2021 for our annual inventory.

## CATALOG ERRORS

We are not responsible for typographical or photographic errors that may appear in any Dadant material. We reserve the right to make adjustments or corrections due to changing market conditions, product discontinuations, or typographical or photographic errors in products.

## Hours:

Contact your local Dadant Branch for hours of operation. Each branch may vary.

## To Place Your Order

For maximum savings on freight, refer to the map on the back cover and select the Dadant branch closest to you.

### PHONE

**By Phone:** Dial the Toll Free Order Number for the Dadant Branch nearest you for better customer service when placing your order. *(For faster service, please have your order written down and your credit card number ready. Also, please know your **Dadant Customer Number** (located above your address label on the back cover) to speed up the order process.*

### FAX

**By Fax:** Make out your order with item numbers and quantity and fax the completed order to your nearest Dadant branch.

### MAIL

**By Mail:** Make out your order with item numbers and quantity and mail the completed order to your nearest Dadant branch.

### ONLINE

**By Internet:** Check out our website: [www.dadant.com](http://www.dadant.com).  
Online ordering available at [www.dadant.com/catalog](http://www.dadant.com/catalog).

## We Ship By:

**National/regional carrier and Truck Freight.** Special priority shipping options available at higher costs.

**Please be sure to provide the correct shipping address with your order. Charges for incorrect addresses will be forwarded to your bill. Additional charges for rural delivery will be added to your invoice.**

WE CANNOT SHIP TO **P.O. BOXES**. PLEASE PROVIDE A PHYSICAL ADDRESS TO SHIP TO.

Check website or call for truck freight quotes.

*If you provide a valid email address, we will send tracking information for your order if the carrier provides this service. Depending on the carrier, shipments may not be able to be traced until 30 days after shipment has been made, which may be unfeasible due to the seasonal nature of our business. We will be happy to provide a quote with any alternate carriers available to us if you request it with your order.*

*We reserve the right to bill you for additional shipping charges. We reserve the right to ship it from a different branch to complete your order in a timely manner.*

*\* Dimensional weight may be used rather than actual weight. Dimensional weight is a formula used by package delivery companies to determine a billing weight based on density. Some items may show the billing weight rather than the actual weight.*

Dimensional rates are calculated on **every shipment**.

## DADANT DEALERS

Bemis Tree Farm (Little Rock, AR)  
LA Honey Co (Los Angeles, CA)  
OC Bee Supply (Fullerton, CA)  
Sacramento Beekeeping Supplies (Sacramento, CA)  
Western Farm Center (Santa Rosa, CA)  
Rocky Mtn Bee Supply (Colorado Springs, CO)  
San Juan Honey (Cedaredge, CO)  
Joseph Bundrick (Crestview, FL)  
The Bee House (Bristol, FL)  
Blue Ridge Honey Company (Lakemont, GA)  
JM Apiaries (Mechanicsburg, IL)  
Petrics Bees (Fontana, KS)  
Next to Nature Farm (Leavenworth, KS)  
Jim Brown Supply Co (Middlesboro, KY)  
Woodcamp Farm (Mt. Airy, MD)  
Turtlebee Farms (Byron, MI)  
St Croix Bee (Shafer, MN)  
Isabees Beekeeping (Fenton, MO)  
Nixa Hardware (Nixa, MO)  
Bailey Bee Supply (Hillsborough, NC)  
Beez Needz (Sophia, NC)  
Blue Ridge Bee Supply (Mt Airy, NC)  
Millie Bee Supply (North Wilkesboro, NC)  
Honey and the Hive (Weaverville, NC)  
Midnight Bee Supply (Vass, NC)  
Hidden Happiness Bee Farm (Deep Gap, NC)

Sapony Creek Apiaries (Rocky Mount, NC)  
Waynes Feed Store (Murphy, NC)  
Valhalla Bee Farm (Lincoln, NE)  
Hudson Valley Bee Supply (Kingston, NY)  
Kutiks Honey Farm (Oxford, NY)  
Maxwells Honey Farm (Sodus, NY)  
Talmage Farm Agway (Riverhead, NY)  
Poulos Apiaries (Edmond, OK)  
RJ's Bee Farm (Owasso, OK)  
Bedillon Honey Farm (Hickory, PA)  
Bee Well Honey (Pickens, SC)  
Johnsons Bees & Supplies (Williston, SC)  
Dakota Honey (Piedmont, SD)  
The Bee Cause (Drummonds, TN)  
The Feed Store (Crossville, TN)  
Honey Bees Unlimited (Gainesville, TX)  
Texas Bee Supply (Blue Ridge, TX)  
Bee Weaver (Navasota, TX)  
Hands on Beekeepers (Chesapeake, VA)  
Uptown Girls Honey (Chesterfield, VA)  
Poor Valley Bee (Hiltons, VA)  
Hungry Hill (Shipman, VA)  
The Bee Store (Woodbridge, VA)  
Let It Bee, Inc. (Greenville, WI)  
Hansen Honey (Rhineland, WI)  
Ridgehaven Bees, LLC (Charleston, WV)



# DADANT BRANCH LOCATIONS

## Hamilton, IL

51 S. 2<sup>nd</sup> Street  
Hamilton, IL 62341-1370  
**Ph:** (217) 847-3324  
**Toll-Free:** 888-922-1293  
**Fax:** (217) 847-3660  
**Email:** [dadant@dadant.com](mailto:dadant@dadant.com)  
**Monday-Friday — Time Zone CST**  
7:00 a.m. to 4:00 p.m.

## Fresno, CA

3914 N Winery Ave.  
Fresno, CA 93727-7450  
**Ph:** (559) 495-0230  
**Toll-Free:** 877-432-3268  
**Fax:** (559) 495-0232  
**Email:** [dadantfresno@dadant.com](mailto:dadantfresno@dadant.com)  
**Monday-Friday — Time Zone PST**  
7:00 a.m. to 4:00 p.m.

## Chico, CA

15 C. Valley Ct.  
Chico, CA 95973-0171  
**Ph:** (530) 893-0921  
**Toll-Free:** 877-332-3268  
**Fax:** (530) 893-0922  
**Email:** [dadantchico@dadant.com](mailto:dadantchico@dadant.com)  
**Monday-Friday — Time Zone PST**  
8:00 a.m. to 11:30 a.m.  
12:30 p.m. to 4:30 p.m.  
**Saturday (March 1- June 1)**  
8:00 a.m. - Noon  
Closed Dec. 24th - Jan. 2nd

## High Springs, FL

17074 Northwest 188th Street  
High Springs, FL 32643-7339  
**P.O. Box 888, High Springs, FL 32655-0888**  
**Ph:** (386) 454-0237  
**Toll-Free:** 877-832-3268  
**Fax:** (386) 454-0240  
**Email:** [dadanths@dadant.com](mailto:dadanths@dadant.com)  
**Monday-Friday — Time Zone EST**  
8:00 a.m. to 5:00 p.m.  
**Saturday — Jan. to May-excluding Holiday weekends**  
8:00 a.m. to Noon  
Commercial sales only by appointment.

## Frankfort, KY

955 Chenault Road, Building D  
Frankfort, KY 40601-9428  
**Ph:** (502) 848-0000  
**Toll-Free:** 888-932-3268  
**Fax:** (502) 848-0009  
**Toll-Free Fax:** 866-932-3268  
**Email:** [dadantky@dadant.com](mailto:dadantky@dadant.com)  
**Monday-Friday — Time Zone EST**  
8:00 a.m. to 5:00 p.m.  
**Saturday (April & May)**  
9 a.m. - Noon

## Sioux City, IA

1318 11th Street  
Sioux City, IA 51105  
**P.O. Box 1735, Sioux City, IA 51102-1735**  
**Ph:** (712) 255-3232  
**Toll-Free:** 877-732-3268  
**Fax:** (712) 255-3233  
**Email:** [dadantia@dadant.com](mailto:dadantia@dadant.com)  
**Monday-Friday — Time Zone CST**  
8:00 a.m. to Noon  
1:00 p.m. to 5:00 p.m.

## Abion, MI

929 Elliott Street  
Albion, MI 49224-9506  
**P.O. Box 183, Albion, MI 49224-0183**  
**Ph:** (517) 629-2860  
**Toll-Free:** 877-932-3268  
**Fax:** (517) 629-3039  
**Email:** [dadantmi@dadant.com](mailto:dadantmi@dadant.com)  
**Monday-Friday — Time Zone EST**  
8:00 a.m. to 5:00 p.m.  
**Saturday Mar. - May-excluding Holiday weekends**  
8 a.m. - Noon

## Williamsport, PA

2925 W 4th St. Bldg 3, Unit 2  
Williamsport, PA 17701  
**Ph:** (570) 980-9831 (Line 1)  
**Ph:** (570) 980-9736 (Line 2)  
**Toll-Free:** 877-532-3268  
**Fax:** (570) 980-9781  
**Email:** [dadantpa@dadant.com](mailto:dadantpa@dadant.com)  
**Monday-Friday — Time Zone EST**  
8:00 a.m. to 5:00 p.m.  
**Saturdays — 1st Sat. in April - last Sat. in Aug. excluding holiday weekends**

## Paris, TX

1169 Bonham Street  
Paris, TX 75460-4056  
**P.O. Box 146, Paris, TX 75461-0146**  
**Ph:** (903) 784-6145  
**Toll-Free:** 877-632-3268  
**Fax:** (903) 784-2161  
**Email:** [dadanttx@dadant.com](mailto:dadanttx@dadant.com)  
**Monday-Friday — Time Zone CST**  
8:00 a.m. to 5:00 p.m.  
**3rd Saturday of the month (January - June)**  
9 a.m. - 3 p.m.

## Chatham, VA

820 Tightsqueeze Industrial Rd.  
Chatham, VA 24531-3305  
**Ph:** (434) 432-8461  
**Toll-Free:** 800-220-8325  
**Fax:** (434) 432-8463  
**Email:** [dadantva@dadant.com](mailto:dadantva@dadant.com)  
**Monday-Friday — Time Zone EST**  
8:00 a.m. to 5:00 p.m.  
**Saturday — (March 1- June 1)**  
8:00 a.m. to Noon

## Watertown, WI

W2763 East Gate Drive  
Watertown, WI 53094-9718  
**P.O. Box 331, Watertown, WI 53094-0331**  
**Ph:** (920) 261-5363  
**Toll-Free:** 877-232-3268  
**Fax:** (920) 261-2309  
**Email:** [dadantwi@dadant.com](mailto:dadantwi@dadant.com)  
**Monday-Friday — Time Zone CST**  
8:00 a.m. to Noon, 1:00 p.m. to 5:00 p.m.

## **Warranty**

Dadant & Sons, Inc., warrants its equipment to be free of defects in material and workmanship. If within 30 days of purchase you feel an item to be defective, please return the merchandise along with your sales slip at once, and we will refund the purchase price along with all transportation charges. This warranty does not cover any damage to equipment arising from alteration, abuse, or use of product for other than its intended purpose. We reject all implied and expressed warranties.

## Convenient Ways To Pay

Check  
Wire Transfer  
Bank Letter of Credit



## For Your Convenience We Accept



# INDEX

- 8 Frame Equipment ..... 26, 27-32
- A**
- AFB Diagnostic Kit ..... 54  
*American Bee Journal* ..... 112  
*American Bee Journal* Binder ..... 112  
Amino-B Booster ..... 47  
AntCant ..... 22, 32  
AP23 ..... 50  
Ap23 Winter ..... 49  
AP23 Microbials ..... 142  
Apiguard ..... 58  
Apistan ..... 59  
Apivar ..... 60  
Apron ..... 76  
Assembled Woodenware ..... 8-10, 13, 24, 29, 33, 55, 63
- B**
- Bag, Gift ..... 137  
Bakeware ..... 125, 138  
Baskets, Cappings ..... 85  
Bee Blower ..... 142  
BBQ Sauce ..... 138  
Bee Blanket ..... 83  
Bee Dun ..... 78  
Bee Escapes ..... 77  
Bee Go ..... 78  
Bee Gym ..... 55  
Beehive Components Chart ..... 5  
Bee Max Equipment ..... 33  
Beeswax Craft Sheets ..... 135  
Beeswax 1 lb. Cake ..... 135  
Beetle Traps ..... 56  
B-Funnel ..... 6  
Beginner Kits ..... 9, 10, 12, 27, 28, 33  
Bellows ..... 34, 35  
Books ..... 40, 112-118, 120-126, 128, 132, 142  
Boot Bands ..... 69  
Bottlers ..... 101-102  
Bottling Bucket Kit ..... 82  
Bottom Board ..... 8, 21, 30, 55, 142  
Branch Information ..... 145  
Brood Builder ..... 48  
Brood DFM ..... 142  
Brush, Bee ..... 37  
Buckets ..... 110  
Bucket Bench ..... 82
- C**
- Cage, Queen ..... 65, 66  
Cake Pans ..... 125, 138  
Camlocks ..... 142  
Candle:  
    Beeswax ..... 133  
    Dipping Rack & Vat ..... 134  
    Fluted Base Former ..... 134  
    Melting Pot ..... 134  
    Mold Cleaner ..... 134  
    Molds ..... 133, 134  
    Silicone Release Spray ..... 134  
    Tea Light Cups ..... 134  
    Wick ..... 134, 135  
Candle Making ..... 132-135  
Candle Making Kit ..... 132  
Candy, Honey ..... 138  
Cappings Basket ..... 85  
Cappings Scratcher ..... 79  
Capping Spinners ..... 91  
Caps, Container ..... 107  
Cart, Super ..... 83  
Catch Box ..... 62  
Children's Suit ..... 72  
Certan B402 ..... 61  
Chute, Bee Blower ..... 142
- Clarifier ..... 99  
Clothing ..... 68-76  
Cloake Board ..... 64  
Collars for Squeeze Bears ..... 107  
Colorant, Soap ..... 130  
Combcapper ..... 80  
Comb Cutter ..... 40  
Comb Honey ..... 40, 41  
Company Policy ..... 143  
Complete supplement ..... 46  
Containers:  
    Bears ..... 106, 107  
    Bulk, Jugs & Pails ..... 108-110  
    Comb Honey ..... 41, 108  
    Glass ..... 44, 103-104  
    Plastic ..... 104, 105  
    Skep ..... 104, 107  
Coveralls ..... 69  
Covers:  
    BeeMax ..... 33  
    Flat Wood ..... 23  
    Garden, Copper ..... 30  
    Inner ..... 24, 31, 33, 77  
    Insulated ..... 23  
    Migratory ..... 23  
    Nuc Plywood ..... 63  
    Stainless Tank ..... 96  
    Telescoping ..... 8, 23, 30  
Creamed Honey Kit ..... 127  
Cutter, Soap ..... 130  
Cylinder Jars ..... 104
- D**
- Dadant Locations ..... 145  
Dadant Hat ..... 141  
Decal ..... 140  
Dipper, Wooden Honey ..... 108  
Disease Management ..... 51  
Dog Collars/Leashes ..... 139  
Domes, Plastic ..... 24, 30  
Drone Comb ..... 18, 55  
Dryer, Honey ..... 100  
DVD's ..... 40, 119, 120
- E**
- EFB Diagnostic Kit ..... 54  
Embedders ..... 19  
Entrance Reducers ..... 39  
Entrance Disc ..... 66  
Escape, Bee ..... 77  
Excluders ..... 25, 62  
Extracting Kits ..... 92  
Extractors ..... 83, 88-91, 93-95  
Eyelet Punch ..... 19  
Eyelets ..... 19  
EZ-Frames ..... 13, 18  
EZI Queen ..... 65
- F**
- Faucet ¾" ..... 110  
FAQS ..... 2-6, 14  
Feed Chart ..... 42  
Feeders, Bee ..... 33, 43-45  
Feeds ..... 46-50  
Fill Master ..... 100  
Filter, Honey ..... 97  
Filter Bags, Honey ..... 97  
Flash Heater ..... 99  
Food Approved Lubricant ..... 88, 94  
Form Board ..... 19  
Formic Pro ..... 59  
Foundation Description ..... 14  
Foundation for:  
    5 11/16 Super ..... 17, 41  
    6 5/8 Super ..... 16
- 9 5/8 Super ..... 15  
Drone Cell ..... 18, 55  
Round Comb Honey ..... 41  
Section/Cut Comb ..... 41  
Small Cell ..... 18, 55
- Frame:  
    Board, Frame ..... 19  
    Cleaner ..... 40  
    Fixer ..... 39  
    Grip ..... 37  
    Holder ..... 39  
    Rests/Rabbets ..... 20, 39  
    Spacers ..... 39  
    Spacing Tool ..... 37  
    Wire ..... 19
- Frames:  
    Assembled ..... 13  
    EZ Plastic ..... 13
- Frames for:  
    5 11/16 Super ..... 17, 41  
    6 5/8 Super ..... 13, 16, 18  
    9 5/8 Super ..... 13, 15, 18
- Fructose ..... 42  
Fructose Pump ..... 42  
Fume Pad ..... 78  
Fumidil-B ..... 61
- G**
- Gaskets, Drum ..... 83  
Gates, Honey ..... 98, 110  
Gift Certificate ..... 141  
Gifts ..... 136-141  
Gloves ..... 72, 75-76, 142  
Glycerine, Soap ..... 129  
Grafting Tools ..... 66, 67  
Grease ..... 88, 94
- H**
- Hat, Dadant Logo ..... 142  
Healthy Bees ..... 51-52  
Heaters:  
    Band & Pail ..... 83  
    Flash ..... 99  
    Immersion ..... 83, 85  
Hex Jars ..... 104, 105  
Hive:  
    Bodies ..... 8, 11, 15, 29  
    Carrier ..... 38  
    Complete ..... 8-12, 29  
    Garden ..... 27  
    Inspection Sheets ..... 52, 123  
    Kits ..... 9, 10, 11-14, 27, 28  
    Net ..... 38  
    Stand ..... 22, 30, 33  
    Support Hive ..... 36  
    Tool ..... 29  
    Top Bar Hive ..... 140  
Hive Customization ..... 4  
Honey Grader ..... 111  
Honey-B-Gone ..... 78  
Honey-B-Healthy ..... 47  
Honey House Layout ..... 84
- J**
- Jackets ..... 68-72  
Jars, Honey ..... 103-107  
Jesters EZ Nuc ..... 63
- K**
- Keychain ..... 139, 142  
Knives ..... 40, 79, 80  
Kit:  
    Bottling Bucket ..... 82  
    Candle Making ..... 132-135  
    Creamed Honey ..... 127





DADANT & SONS, INC.  
 51 South 2<sup>nd</sup> Street  
 HAMILTON, IL 62341-1397



CHANGE SERVICE REQUESTED

## DADANT BRANCH LOCATIONS & TOLL-FREE NUMBERS

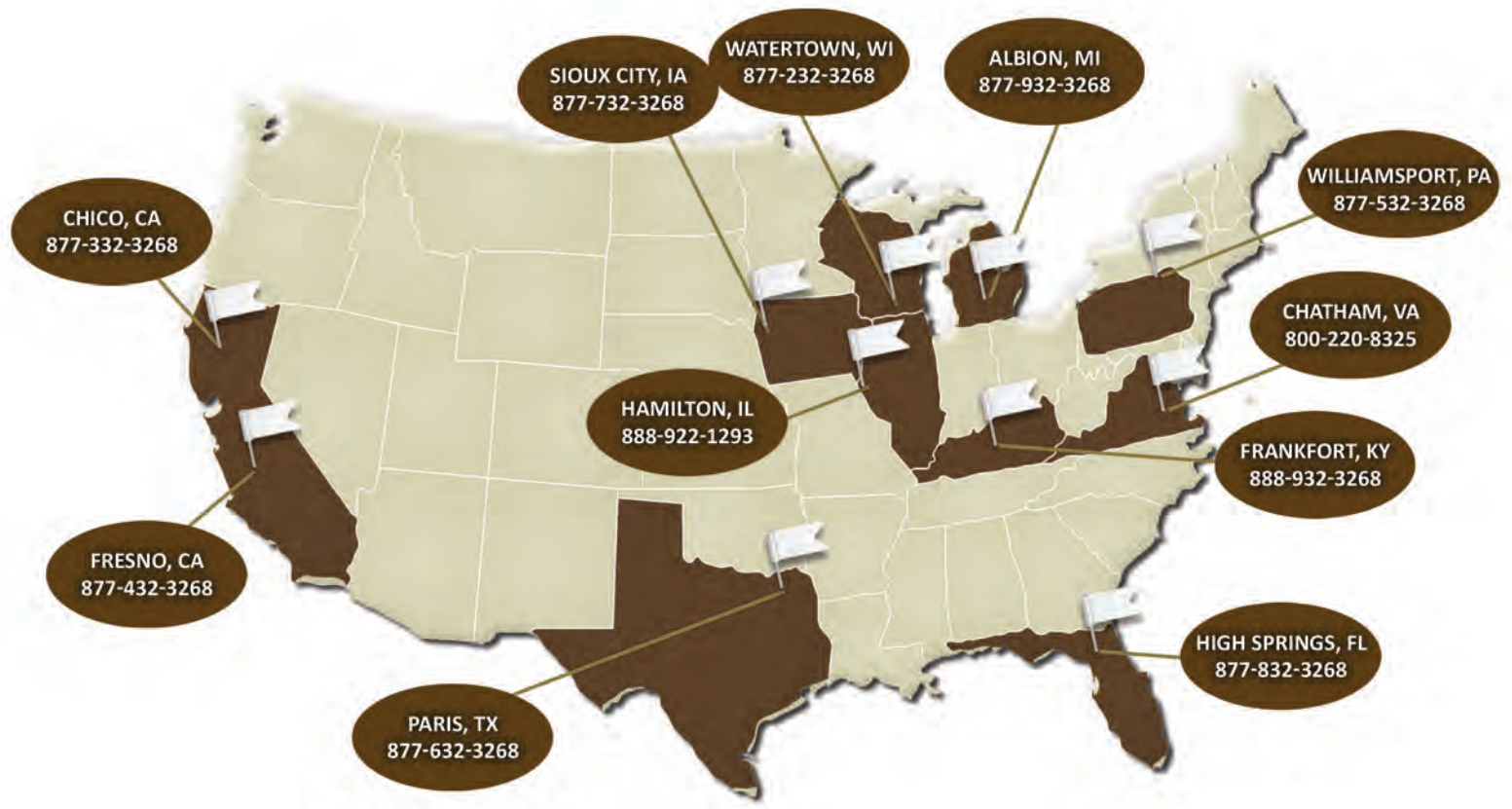

Email: [dadant@dadant.com](mailto:dadant@dadant.com)  
 Website: [www.dadant.com](http://www.dadant.com)

MAP SCALE  
 1 INCH = 400 MILES